

**MEGA**<sup>TM</sup>  
**CONSTRUX**



**WONDER**  
**BUILDERS**<sup>TM</sup>

**GNY53**

**FIGHTER JET - JET DE COMBAT**

CAZA - AVIÃO DE COMBATE - KAMPFJET - ИСТРЕБИТЕЛЬ





Fuel their imagination with building toys that support creative thinking and problem solving.

Stimulez leur imagination avec des jouets de construction qui encouragent l'esprit créatif et la résolution de problèmes.

Alimenta su imaginación con juguetes de construcción que ayudan a desarrollar el pensamiento creativo y la resolución de problemas.  
Abasteça a imaginação dele com brinquedos de montar que suportam o pensamento criativo e a resolução de problemas.  
Dieses Bauspielzeug befähigt nicht nur die Phantasie, sondern unterstützt auch kreatives und lösungsorientiertes Denken.  
Разжигайте воображение детей с помощью конструктора, развивающего творческие способности и логическое мышление.



### Authentic details Détails authentiques

Detalles auténticos / Detalhes autênticos  
Authentische Details / Реалистичные детали



### Special pieces Pièces spéciales

Piezas especiales / Peças especiais  
Spezielle Teile / Специальные детали

### Learn more Pour en savoir plus

Más información • Sabe mais  
Weitere Infos gibt es auf • Узнать больше

[play.megaconstrux.com](http://play.megaconstrux.com)



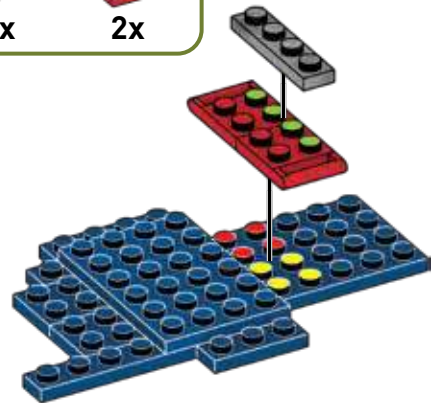
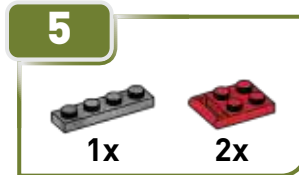
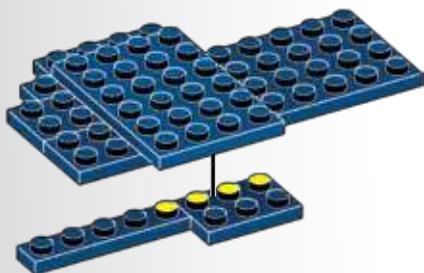
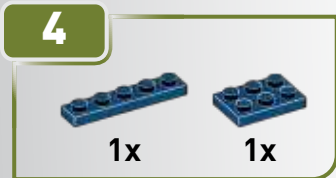
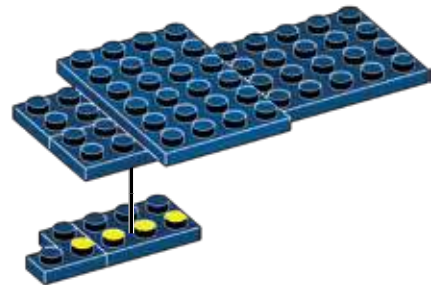
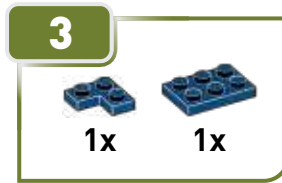
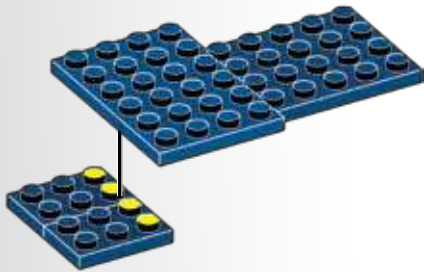
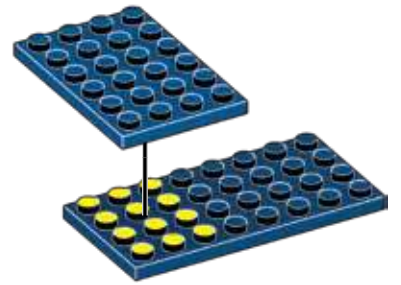
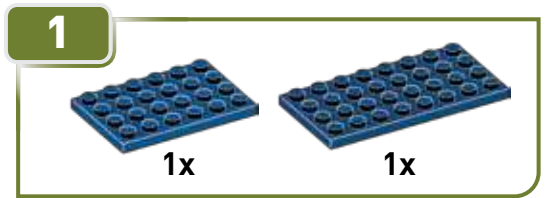

6



2x

1x

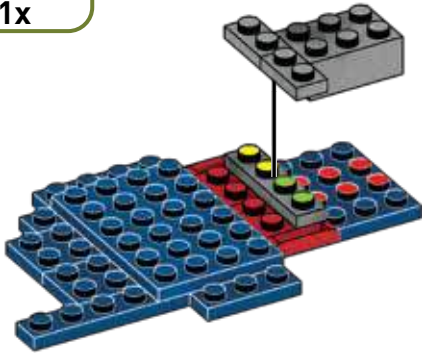

7



2x

2x

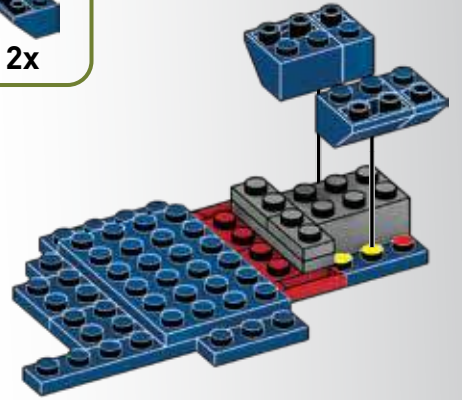

8



4x

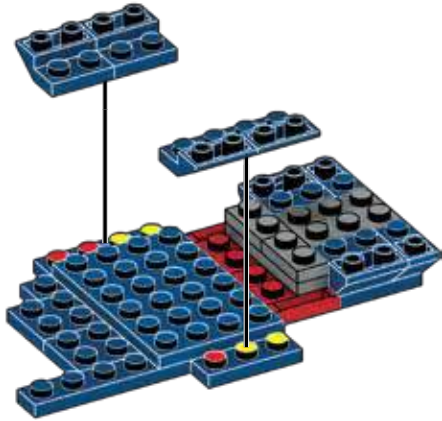

9



1x

2x

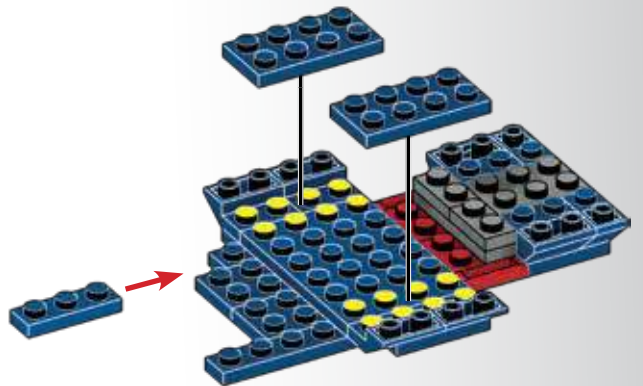

10



1x

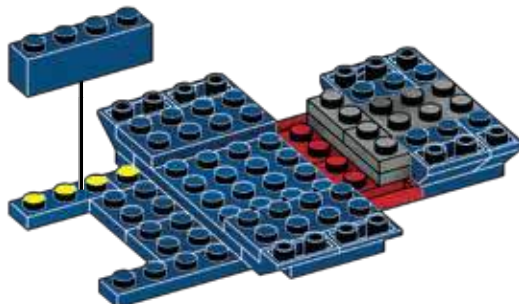

11

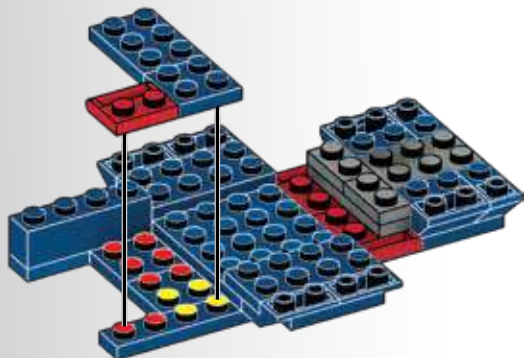

12

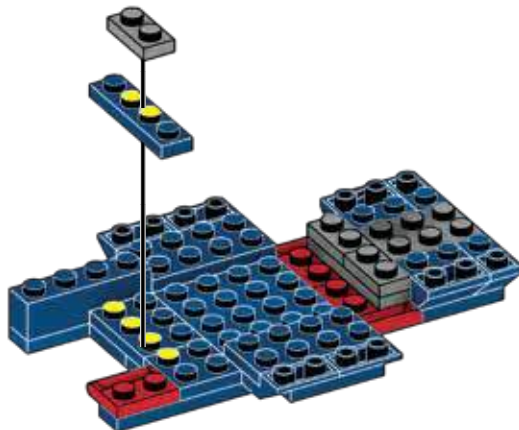

13



2x

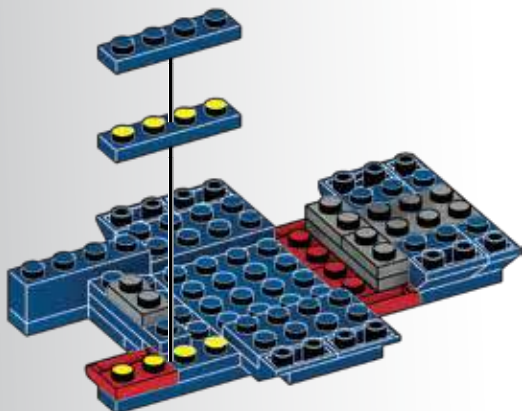

14



3x

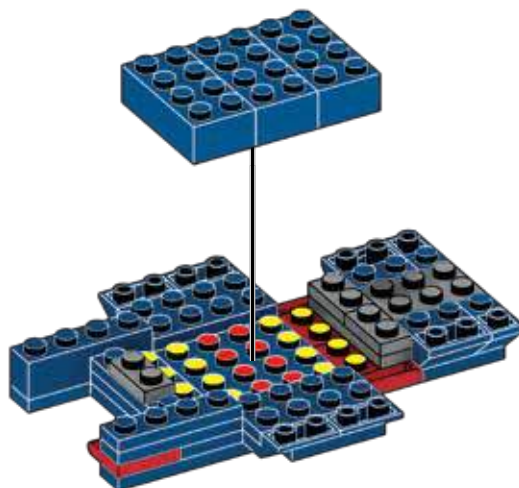

15



2x



1x

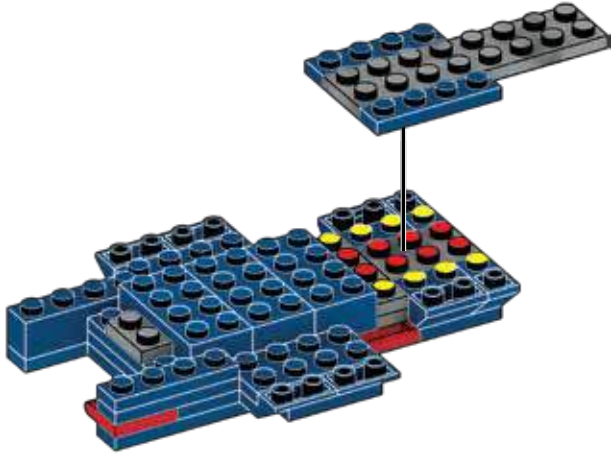

16



2x

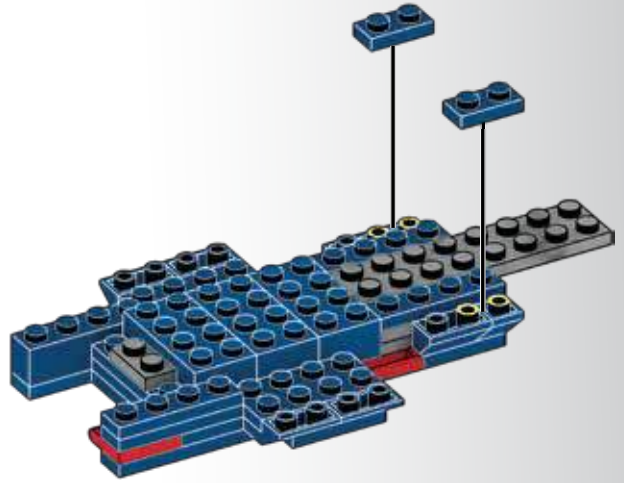

17



1x



1x

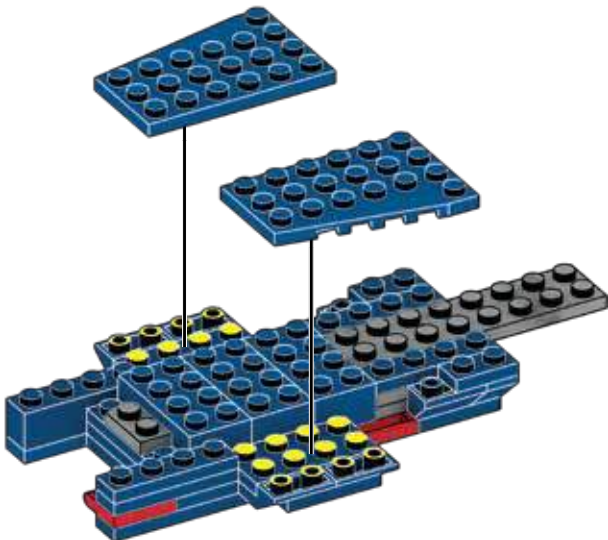

18



1x



1x

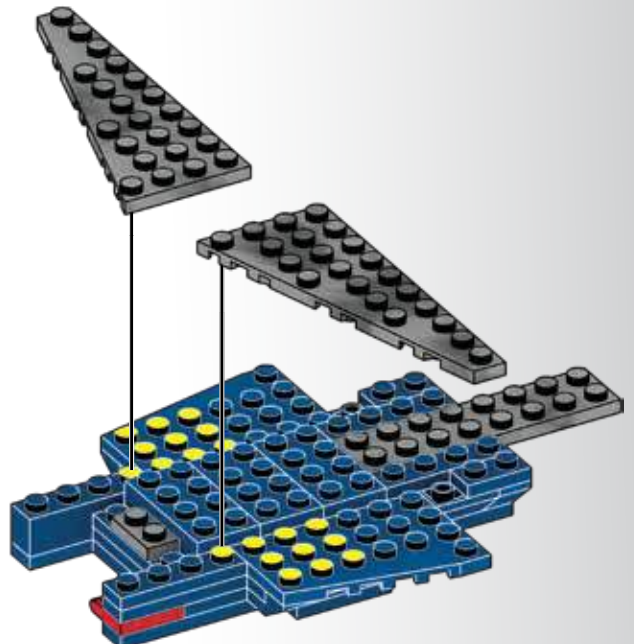

19



2x

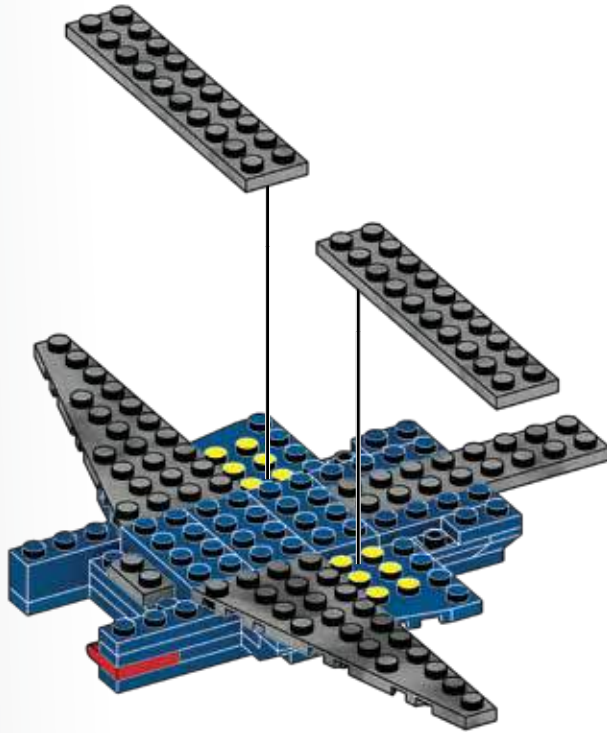

20



1x



1x

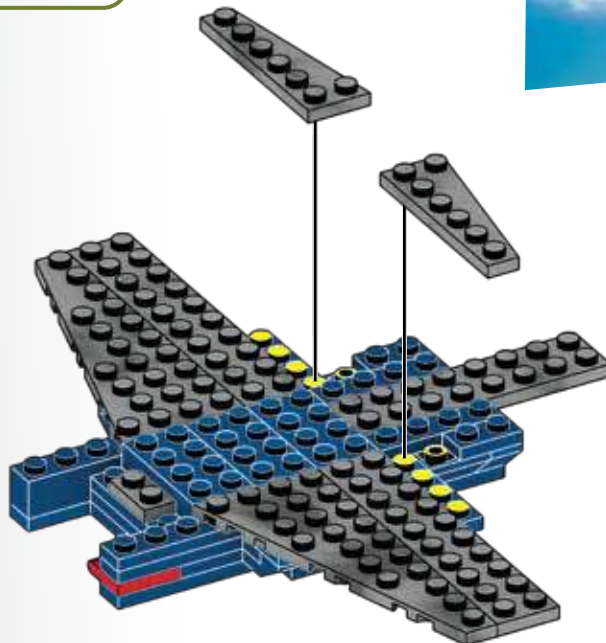

21



2x



1x

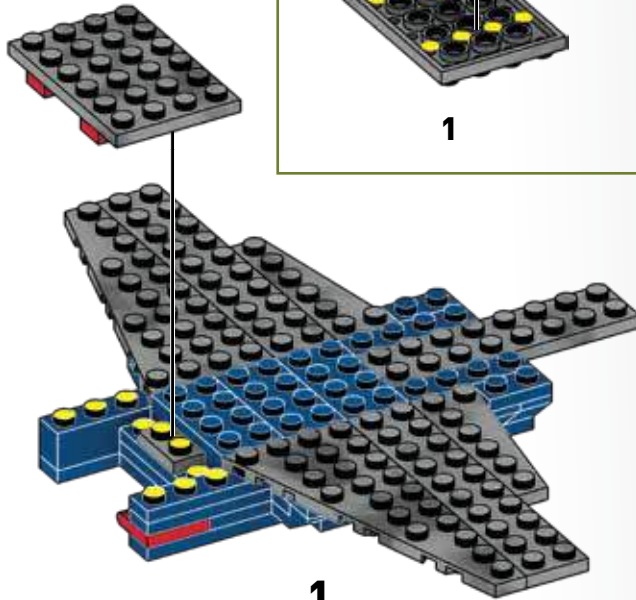

1

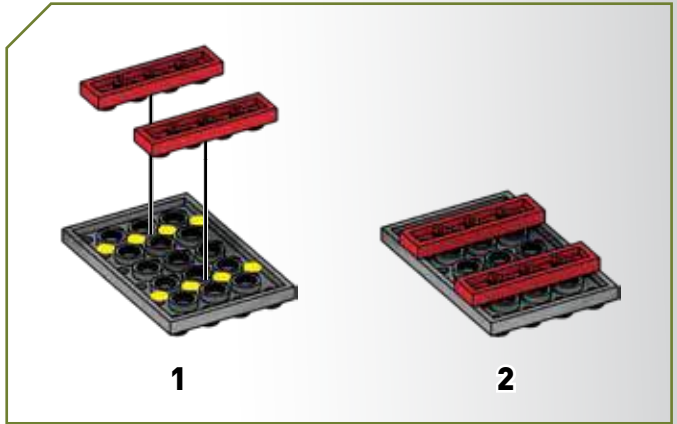

1

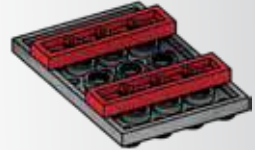

2

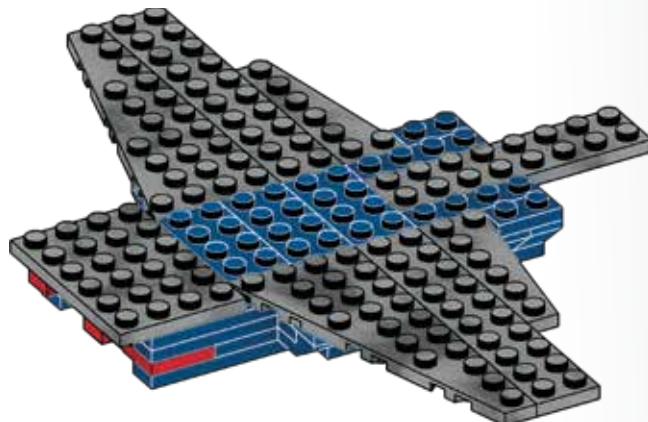

2



22

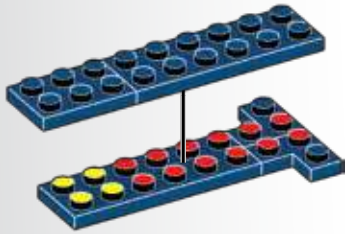
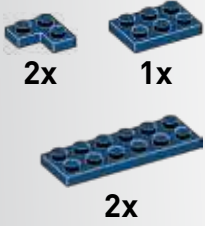

23

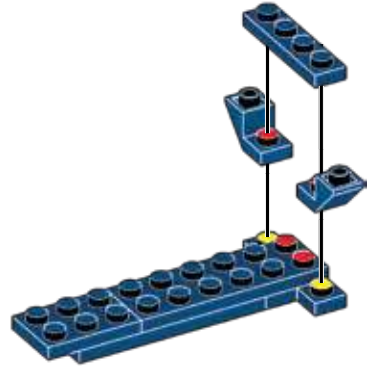

24

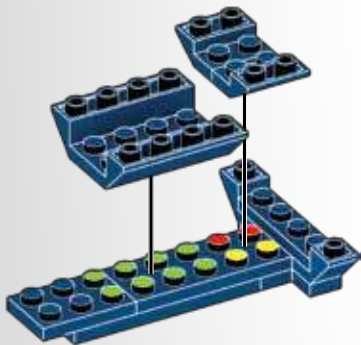

25

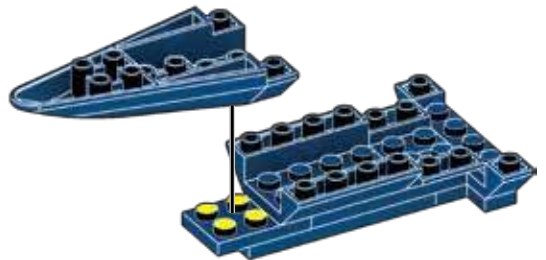

26



1x



1x

27



1x



1x

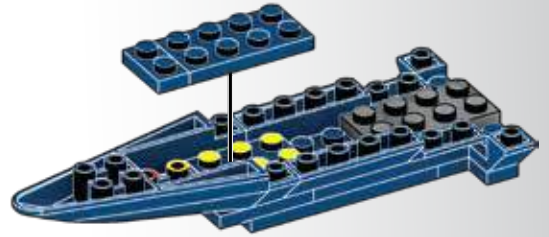

28

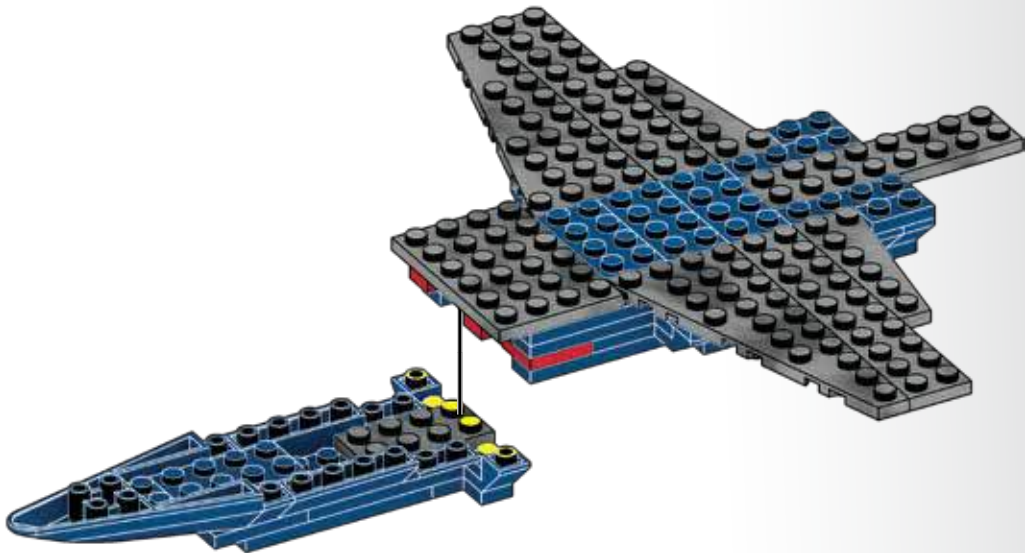

29



3x



1x

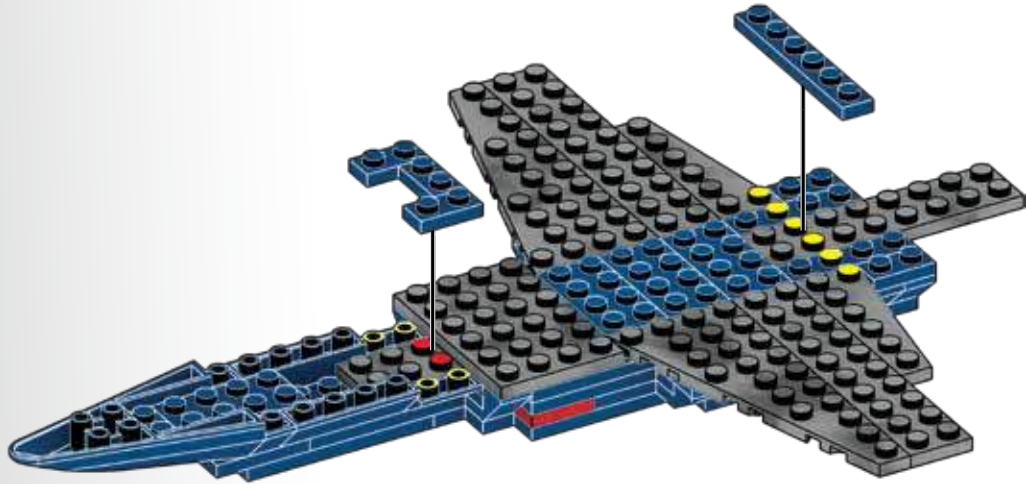

30



4x

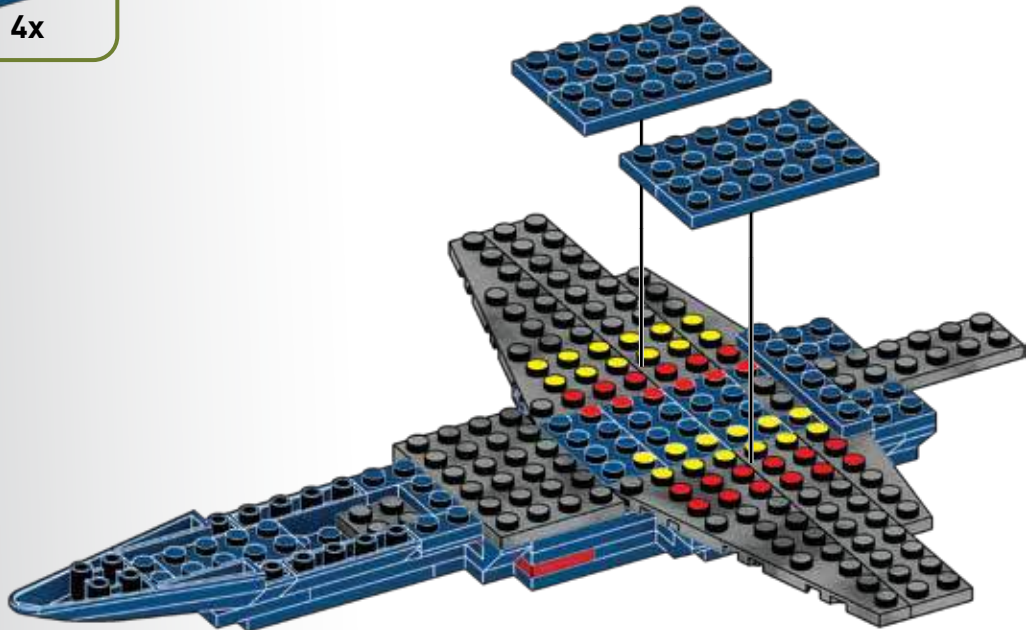

31



2x



1x



1x

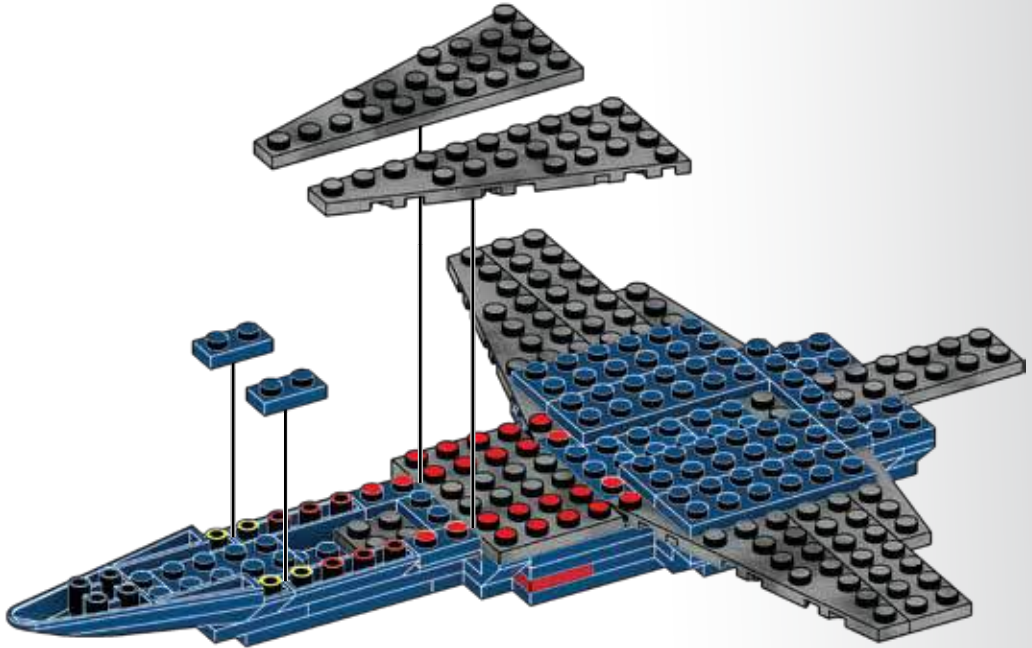

32



1x



1x



33



1x

1x



34



1x

1x

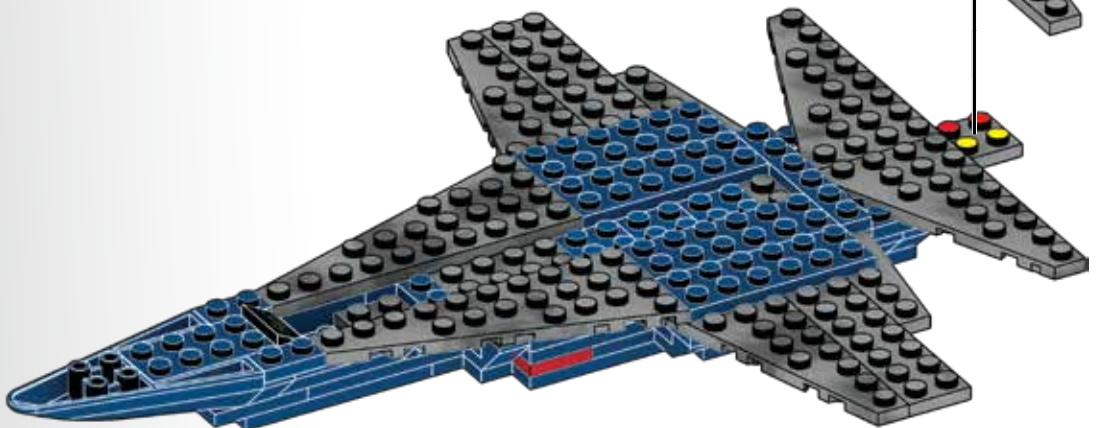
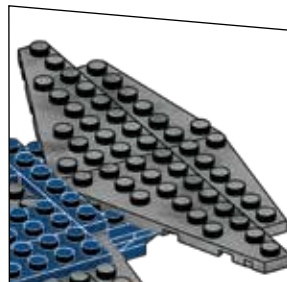



**35**

2x      2x

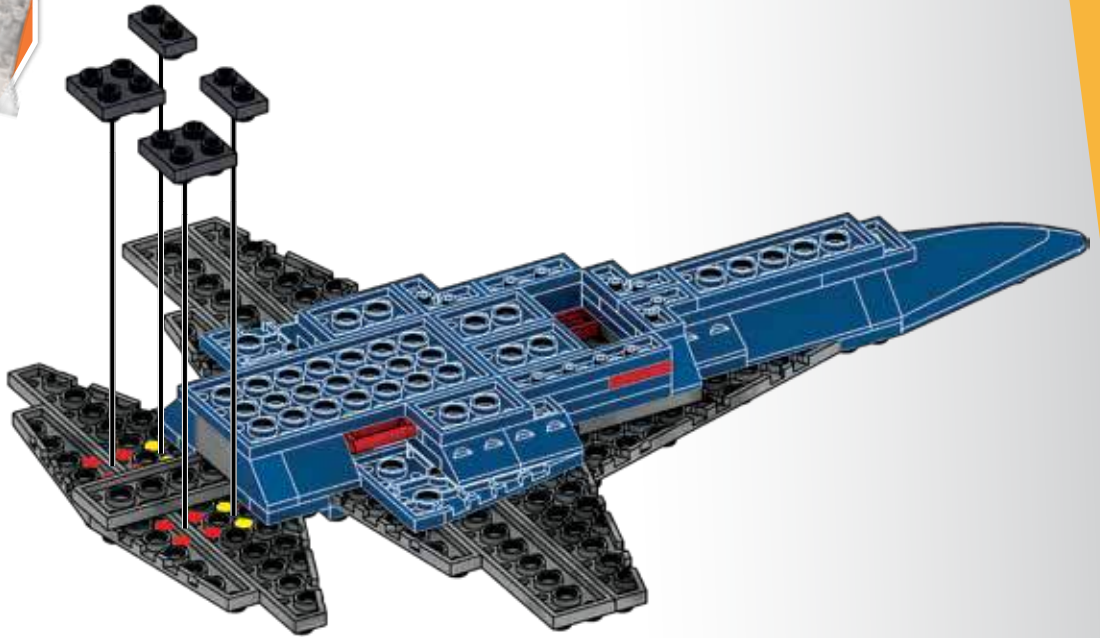

**36**

1x  
1x

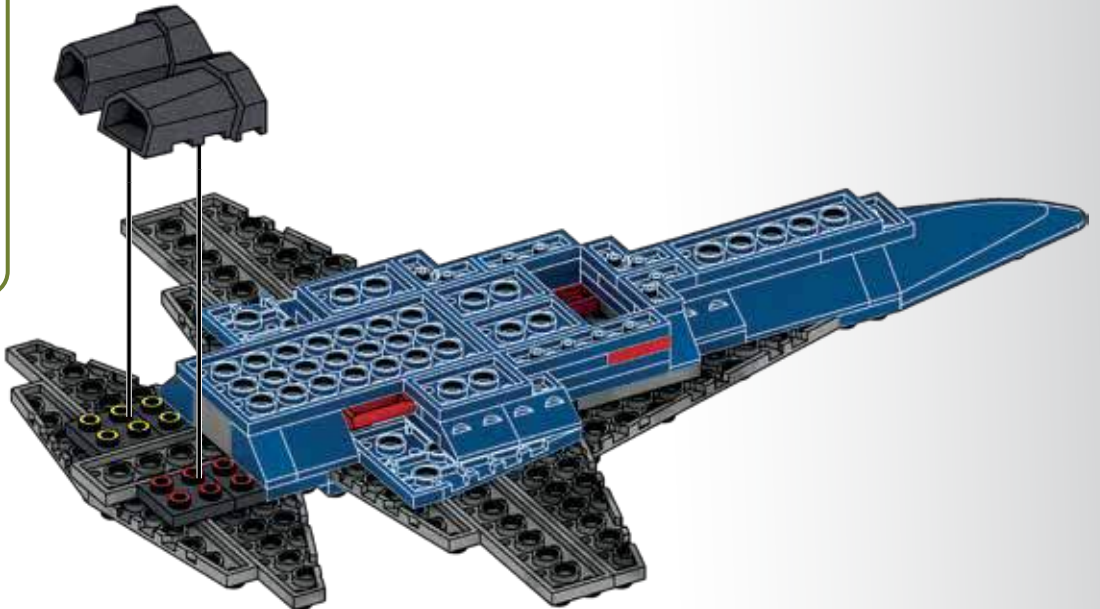

37



8x



4x



2x

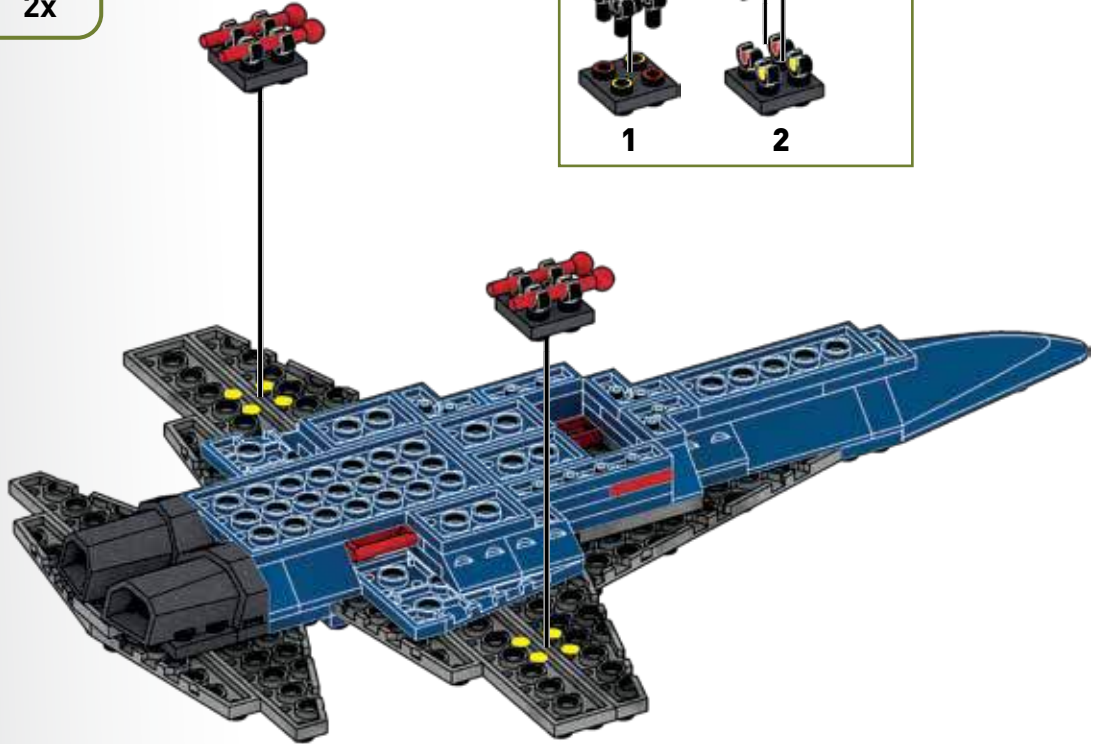
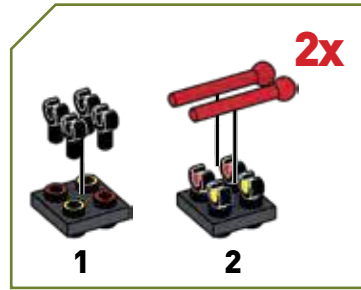

38



2x



2x

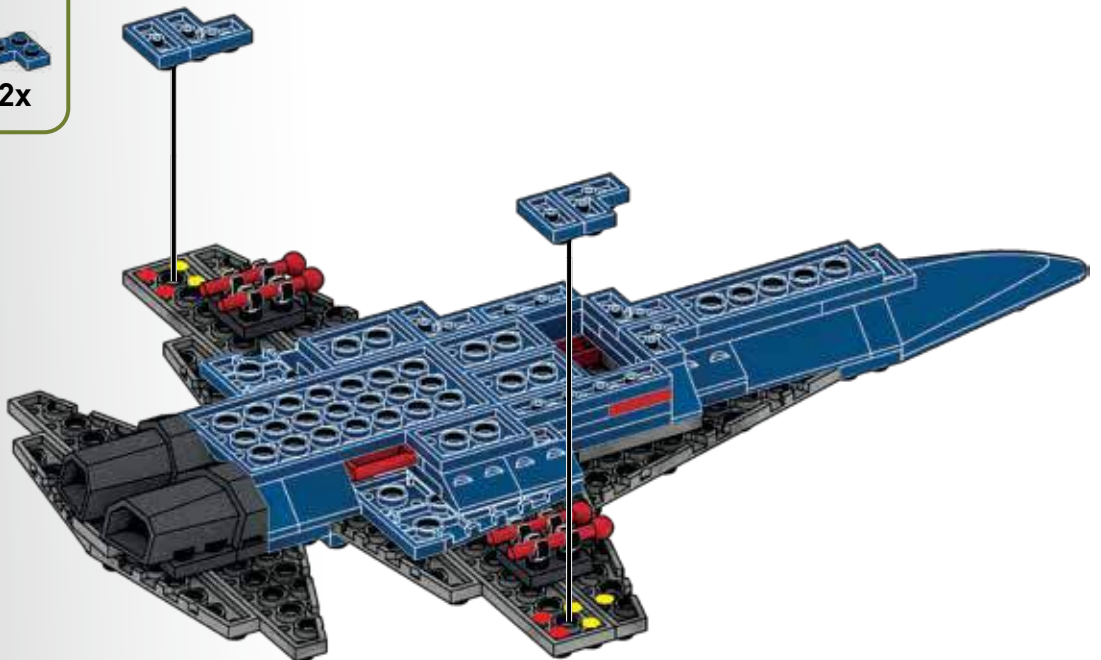

39



2x



2x

2x



1



2

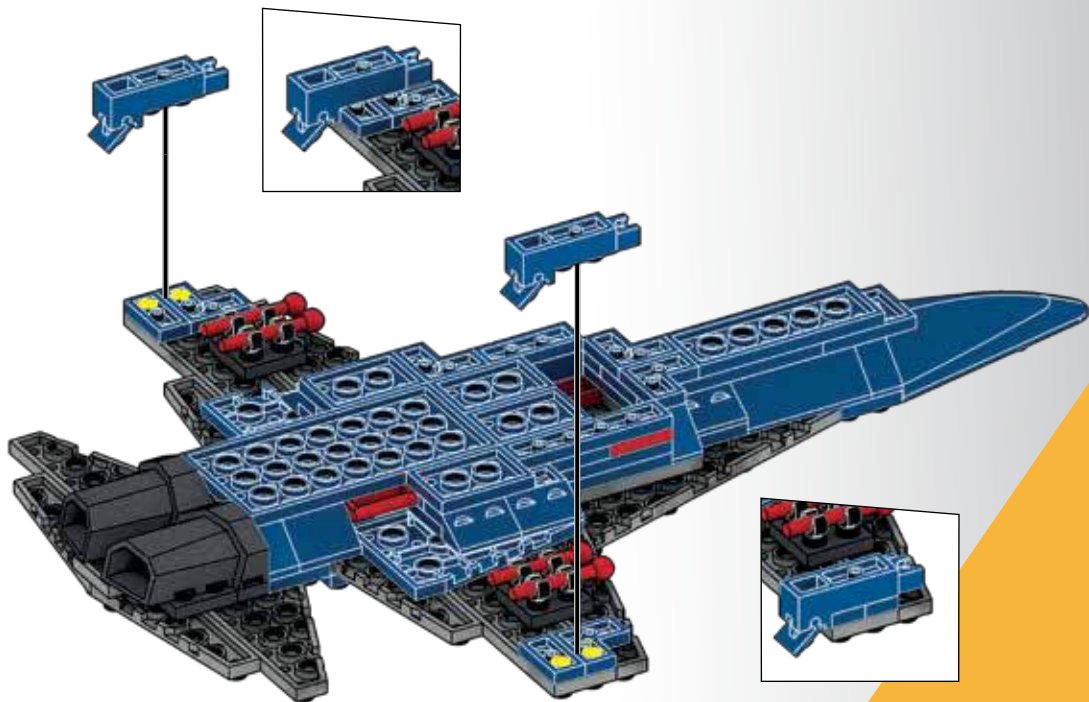

40



2x



2x





41



1x

2x

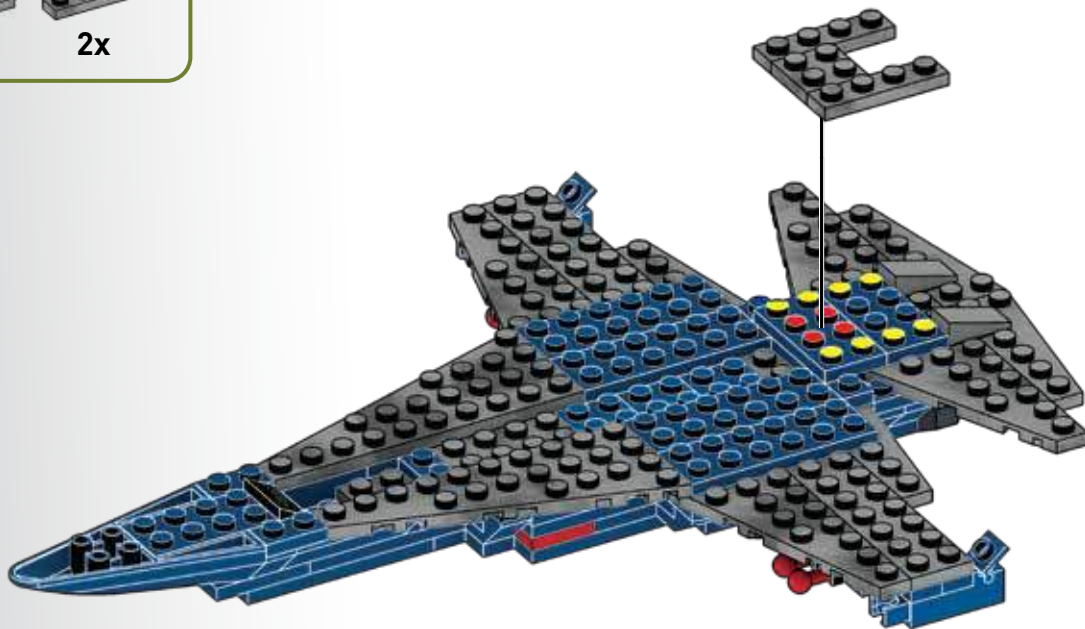

42



2x

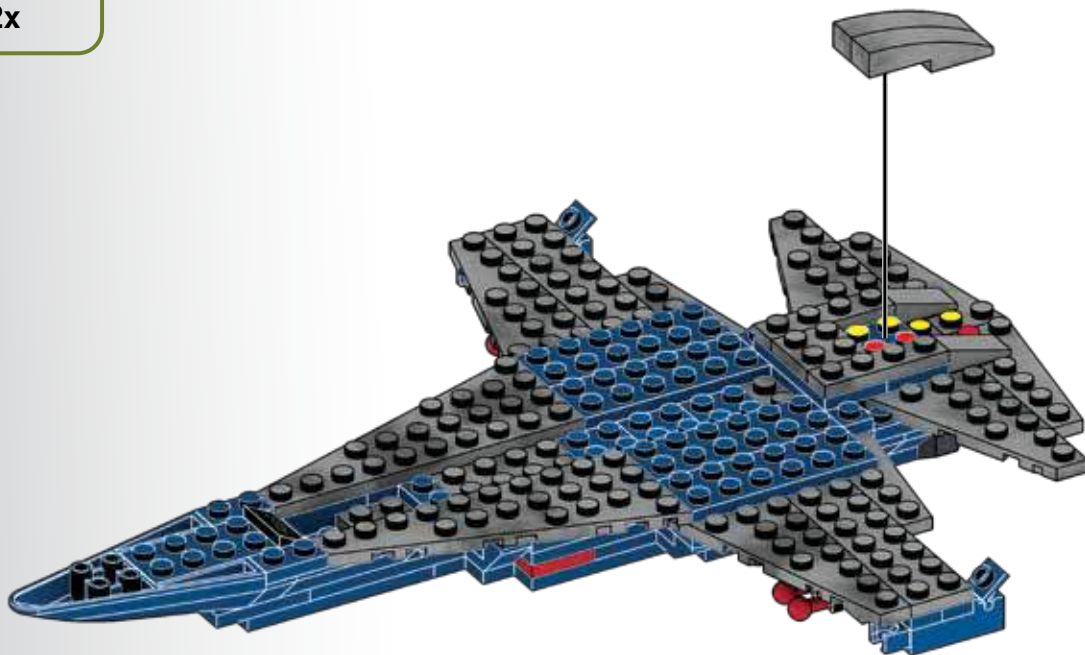

43



1x



2x

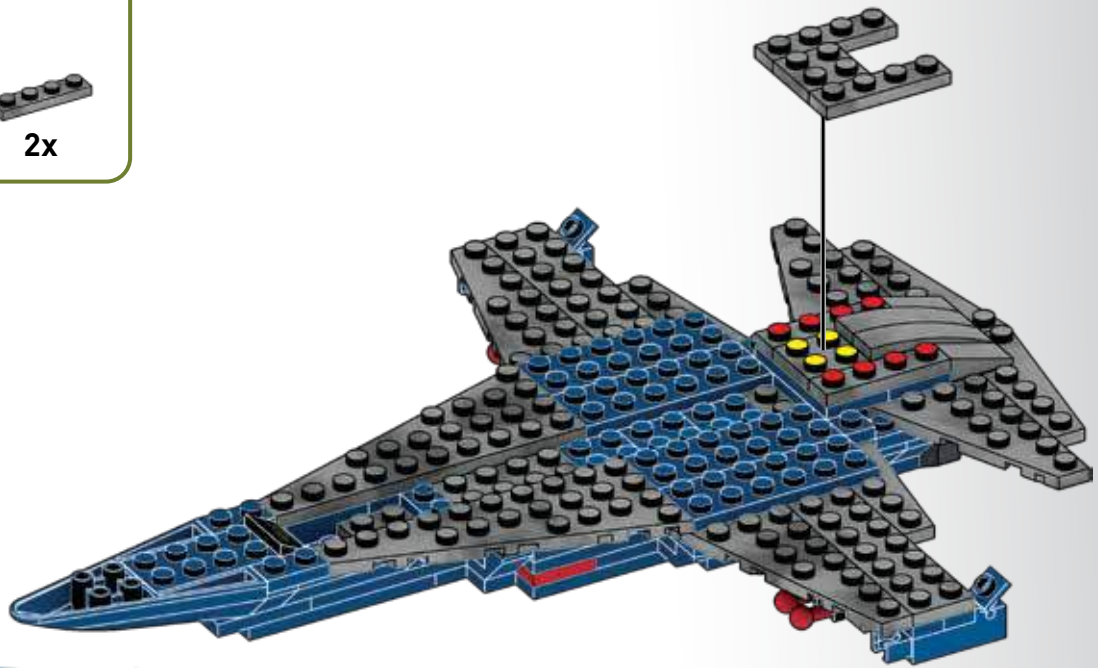

44



1x



1x

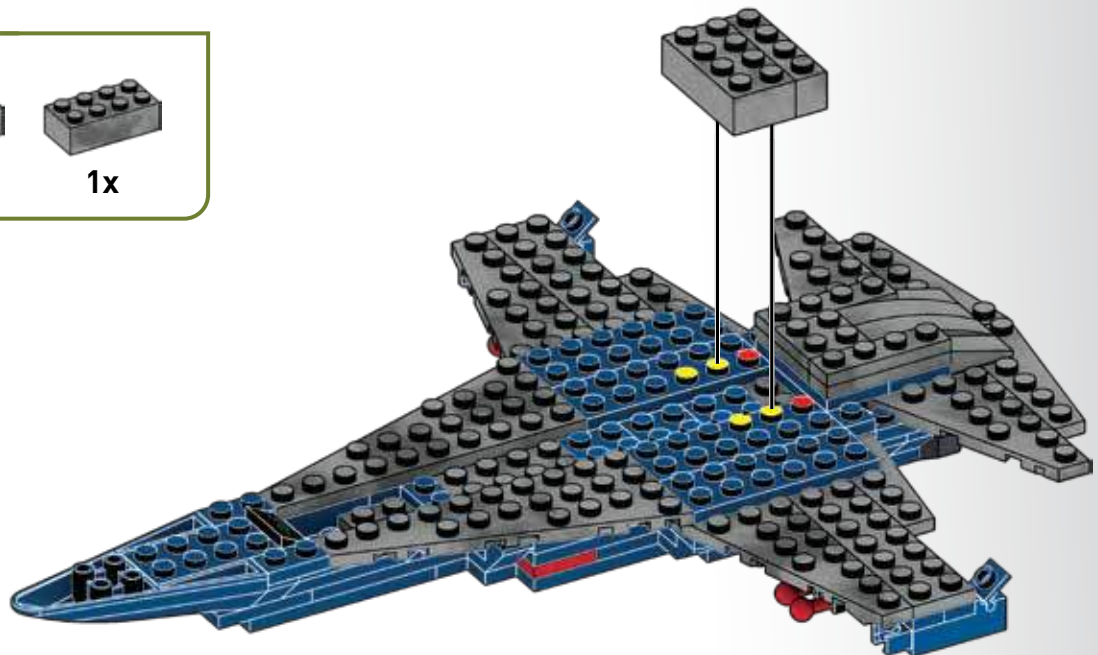

45



2x



1x

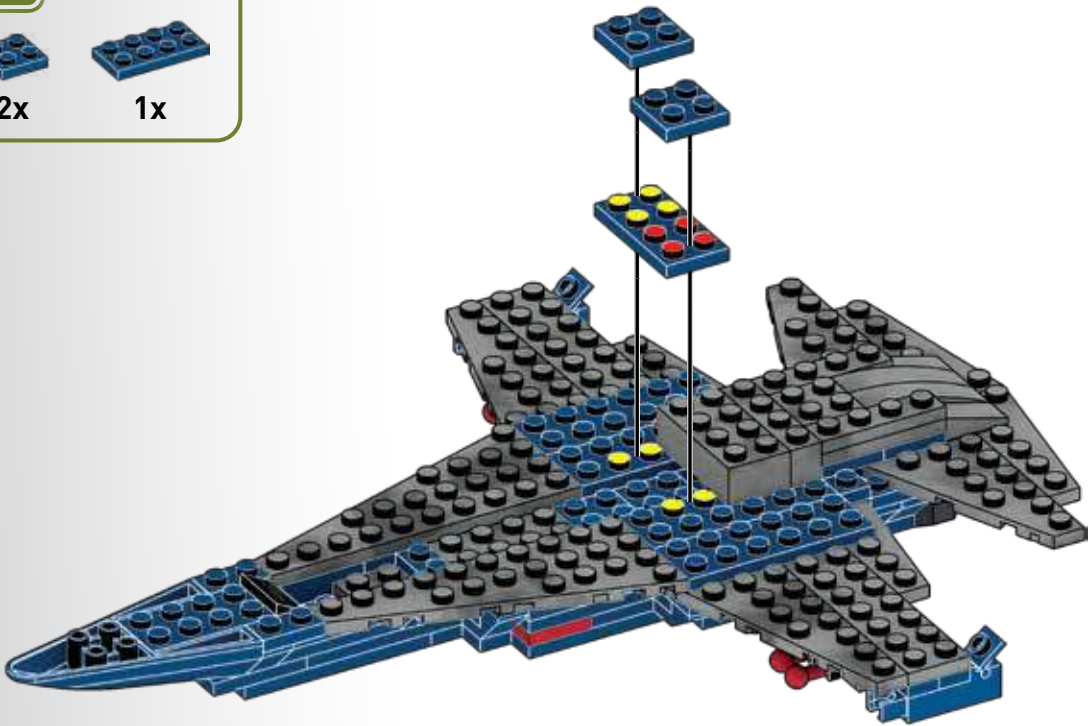

46



1x



1x

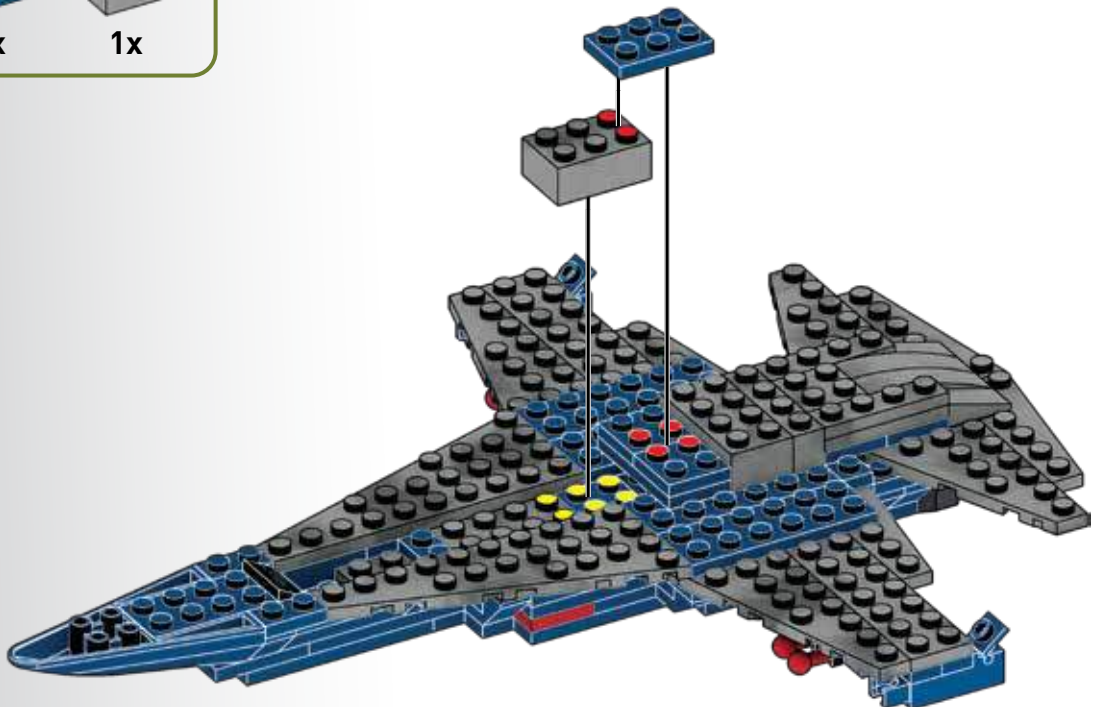

47



1x

1x

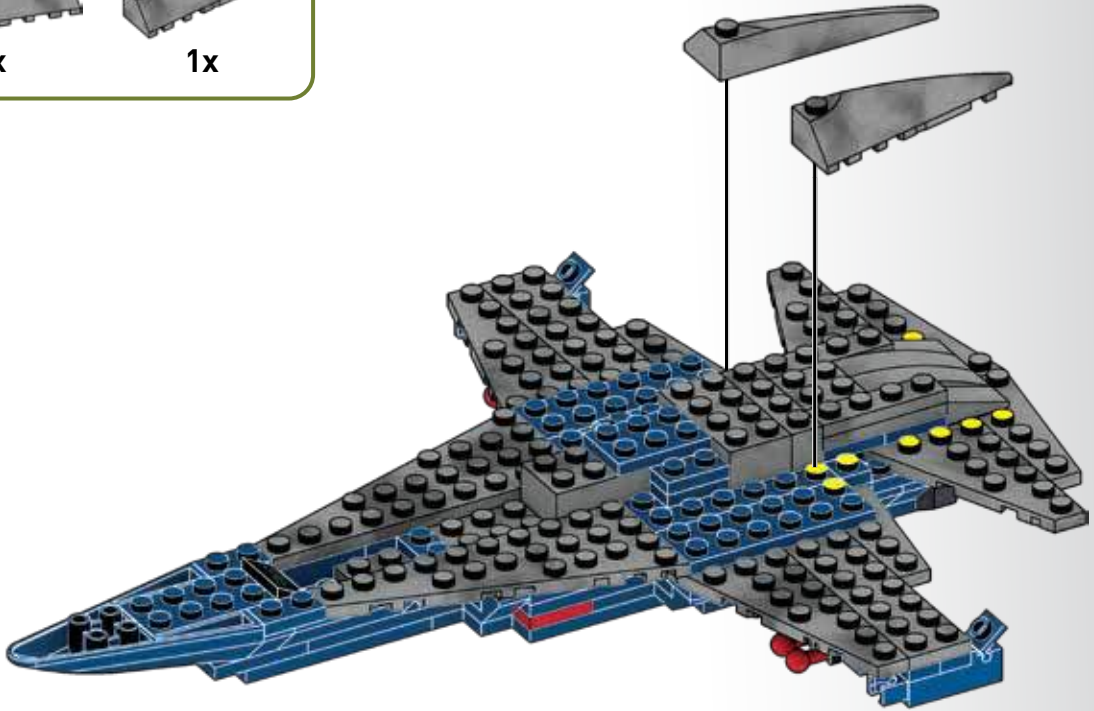

48



2x

2x

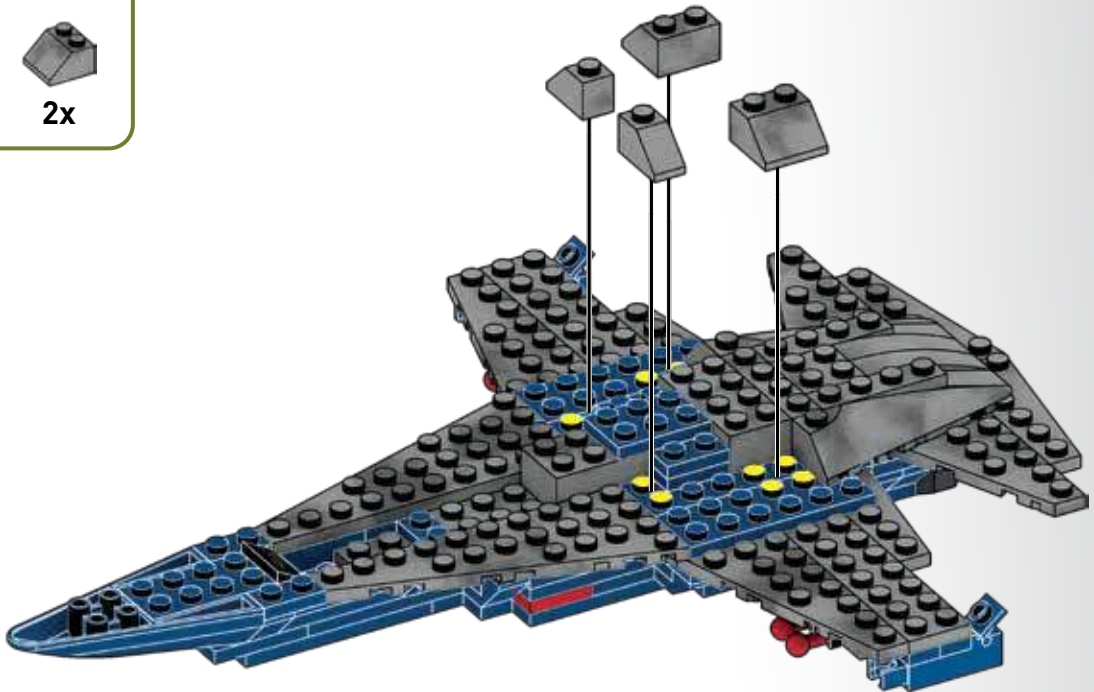

49



2x

2x

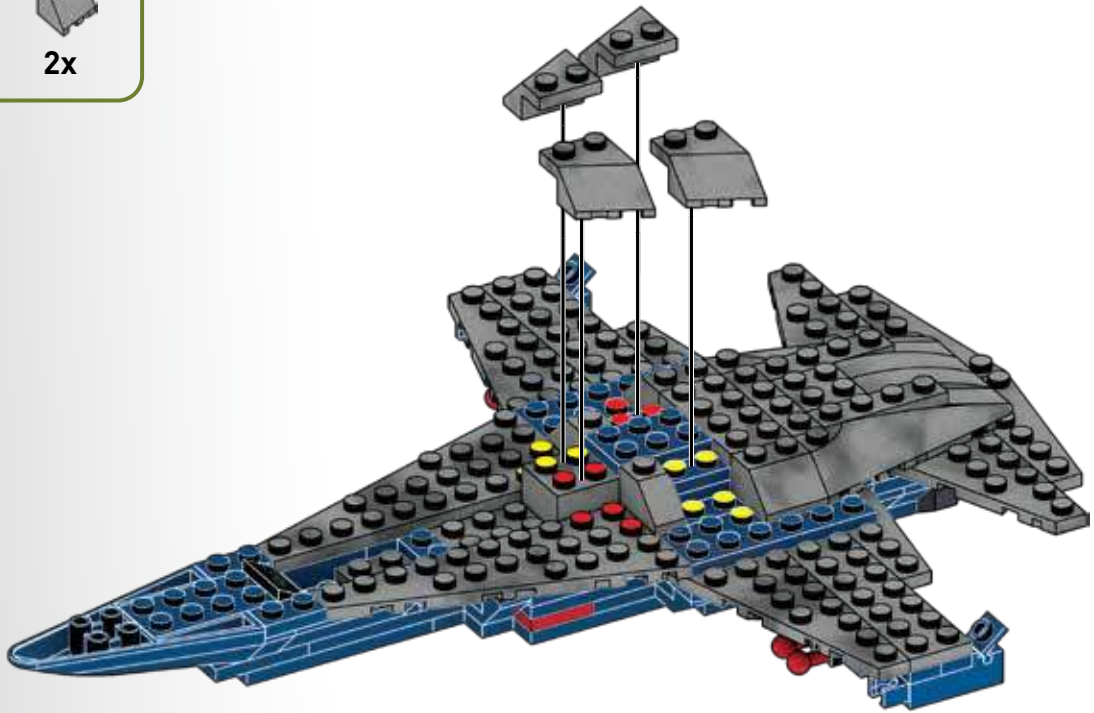

50



2x

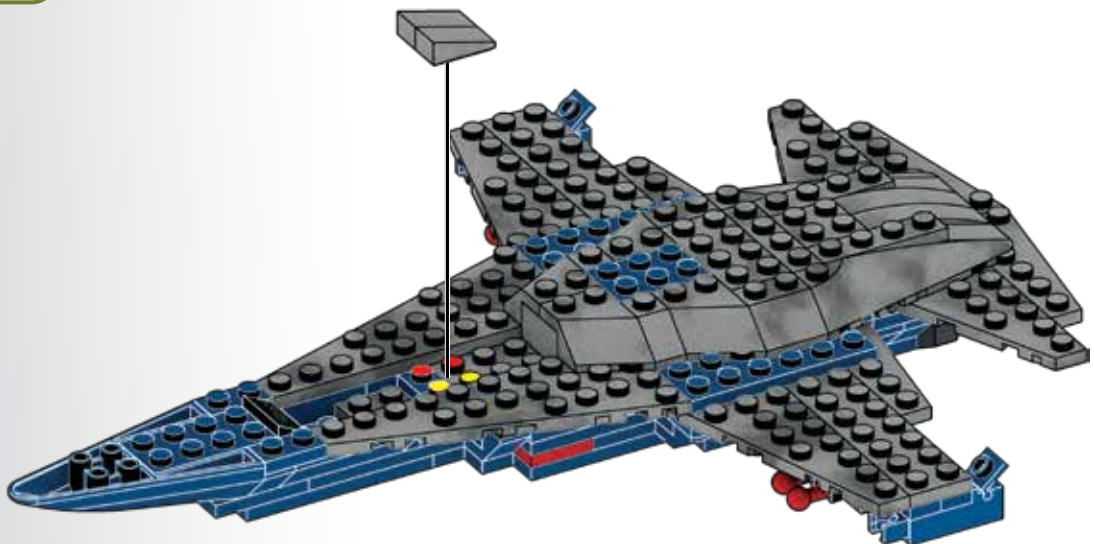

51



1x



1x

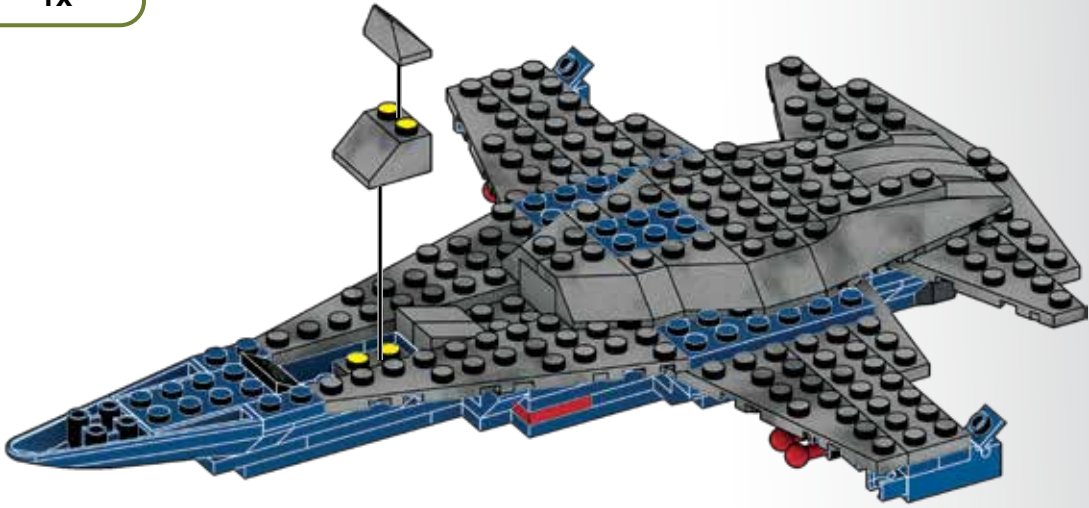

52



1x

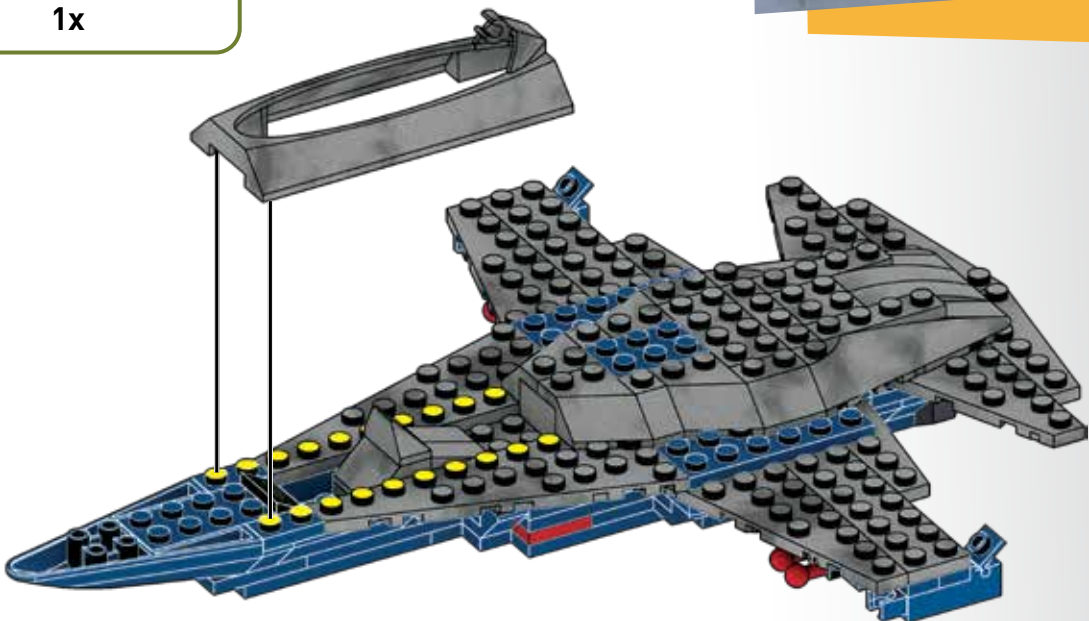

53



1x



1x



1x



1x



1x

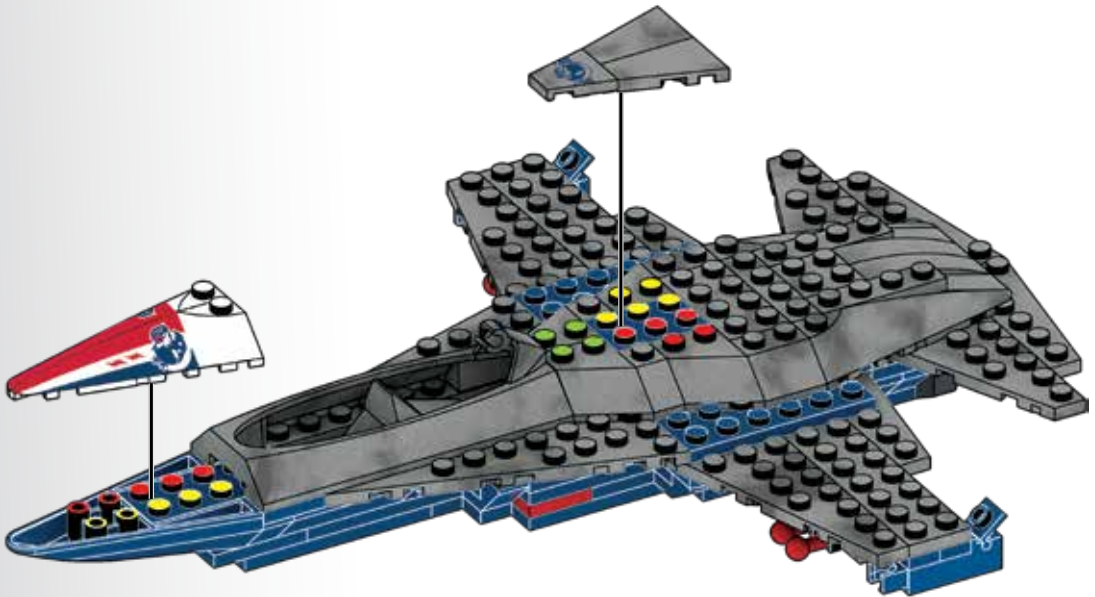

54



2x



4x



2x

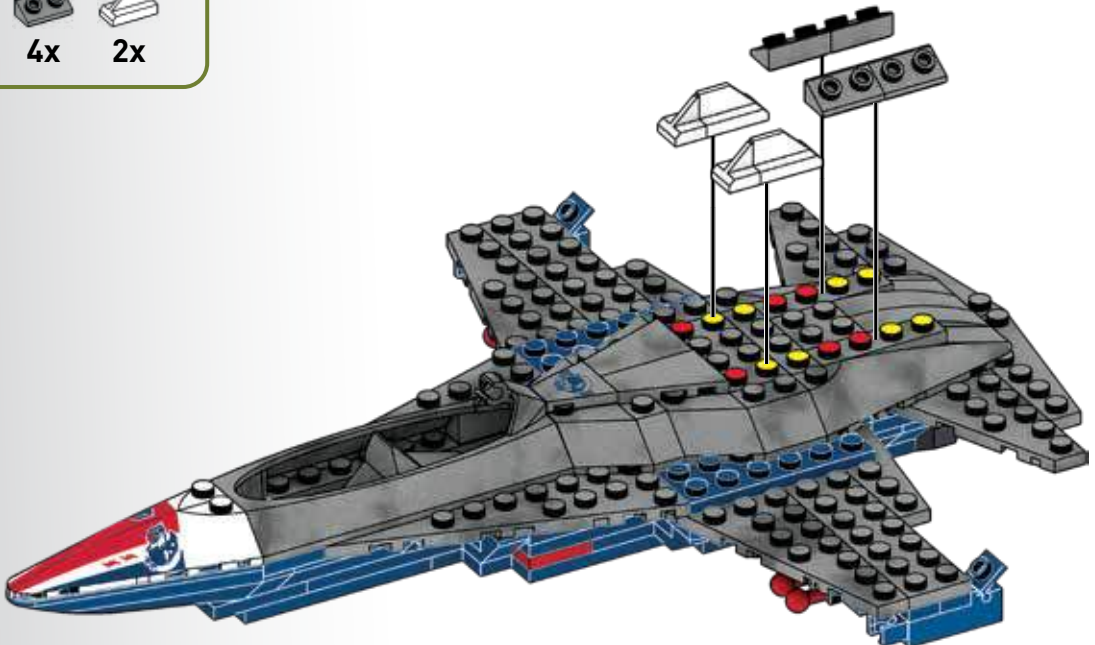

55



1x



1x



2x



4x

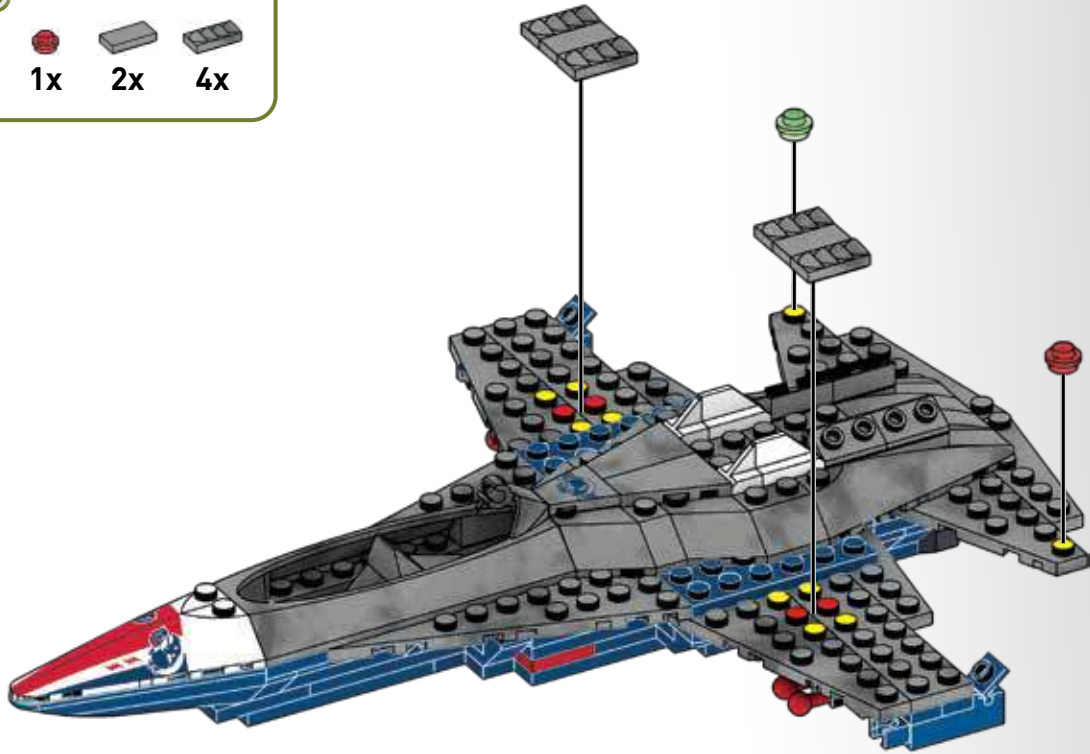

56



3x



3x

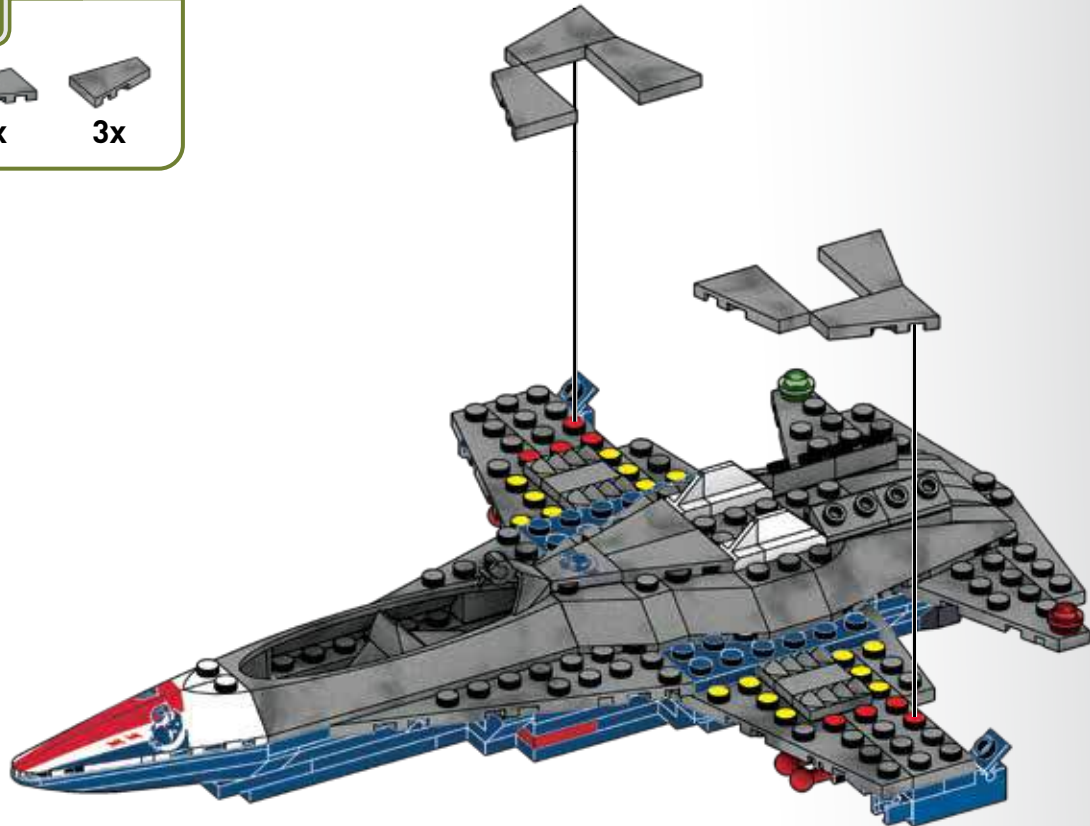



57



2x



2x

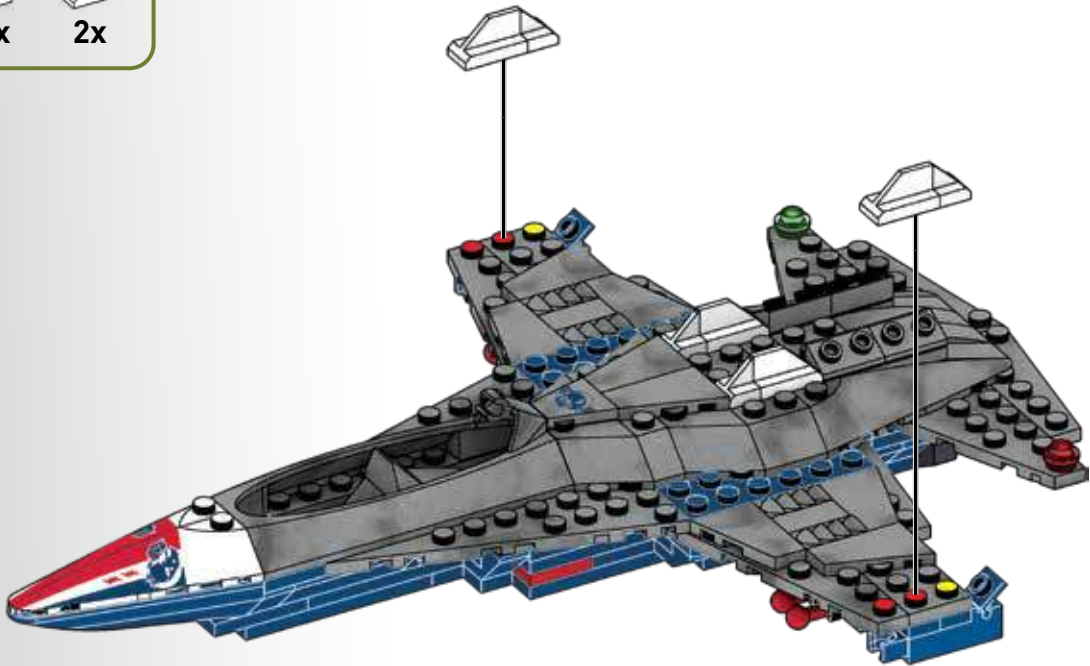

1

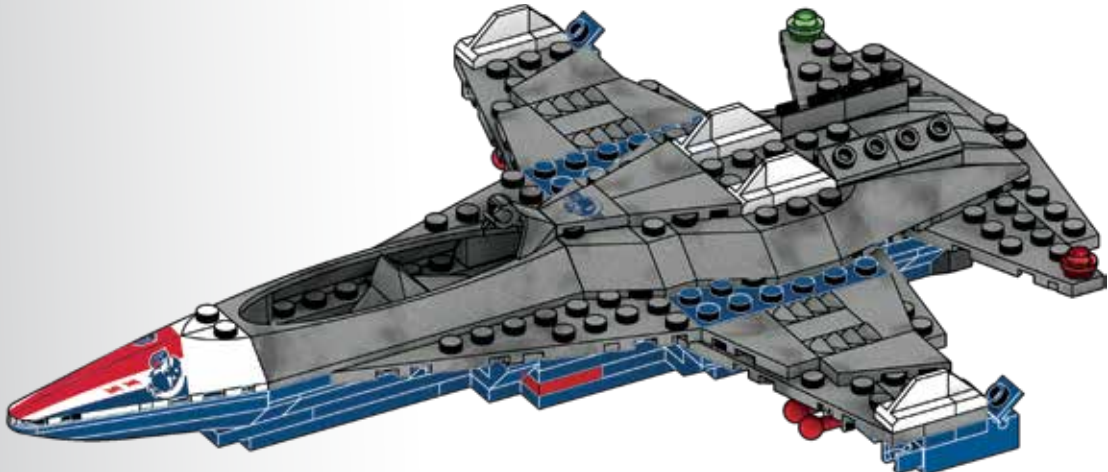

2

58

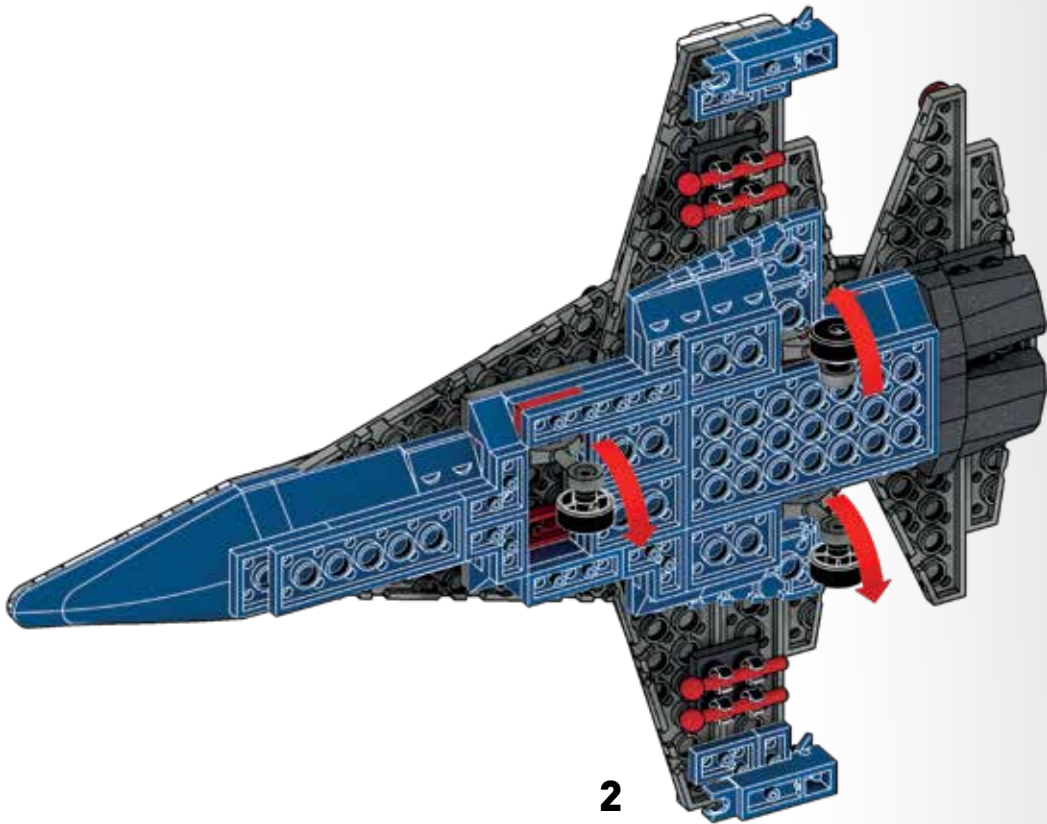
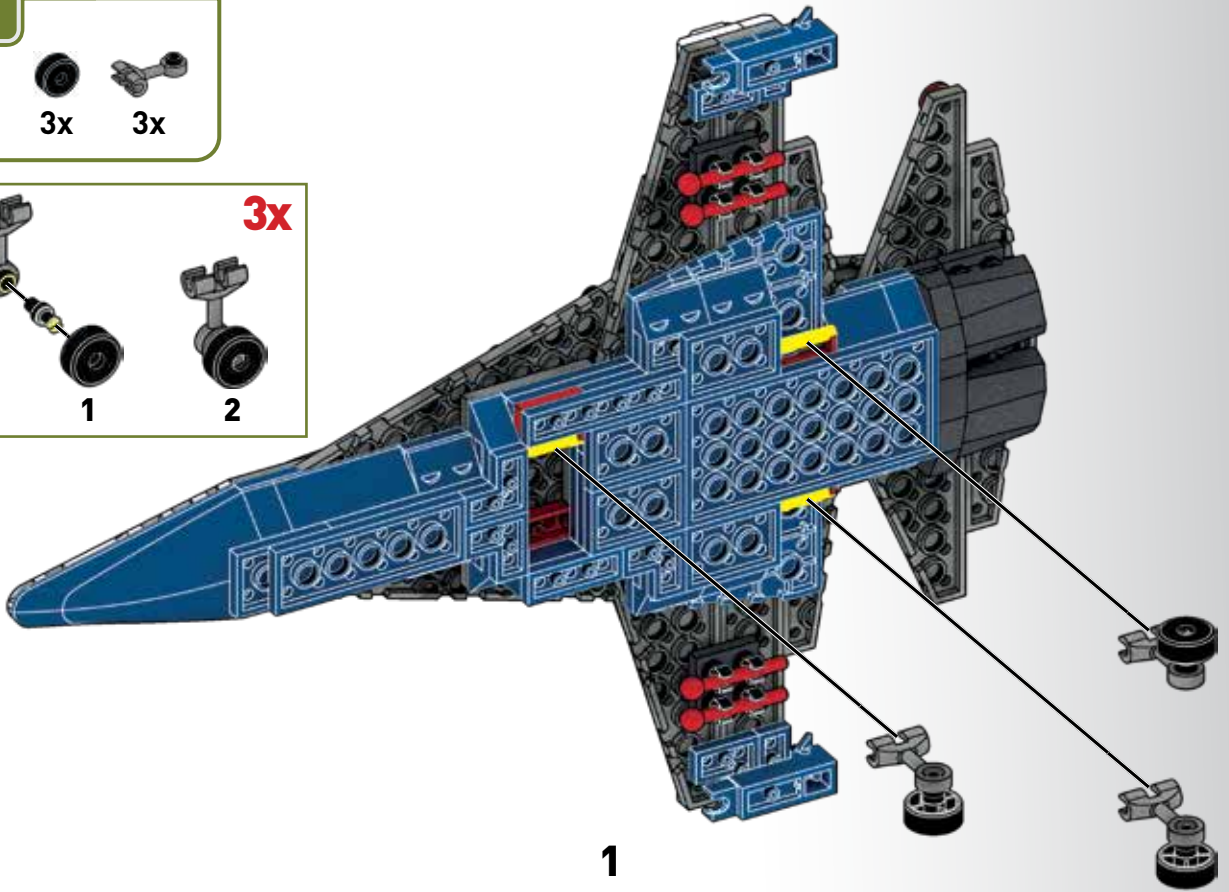
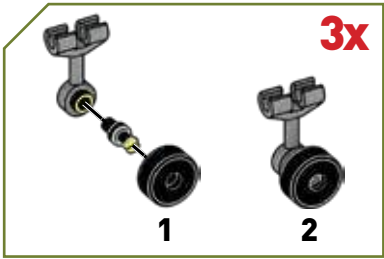

59



3x

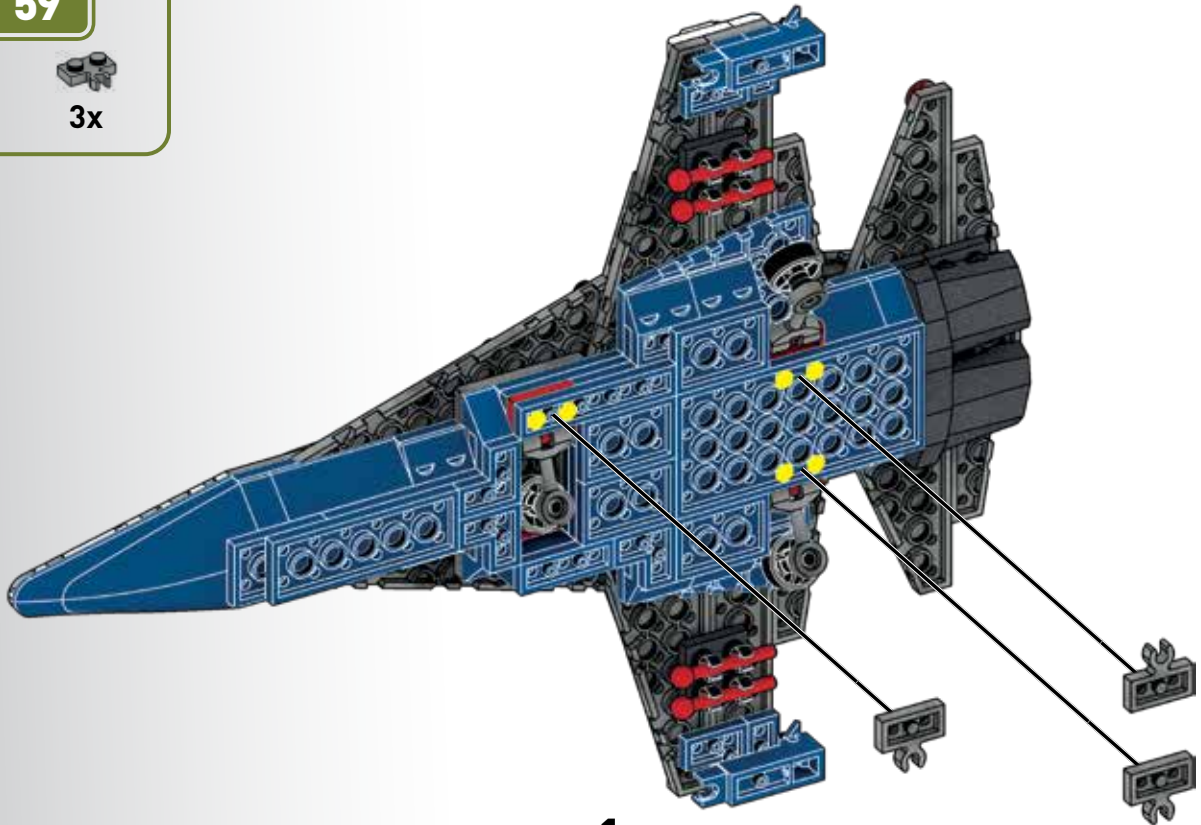

1

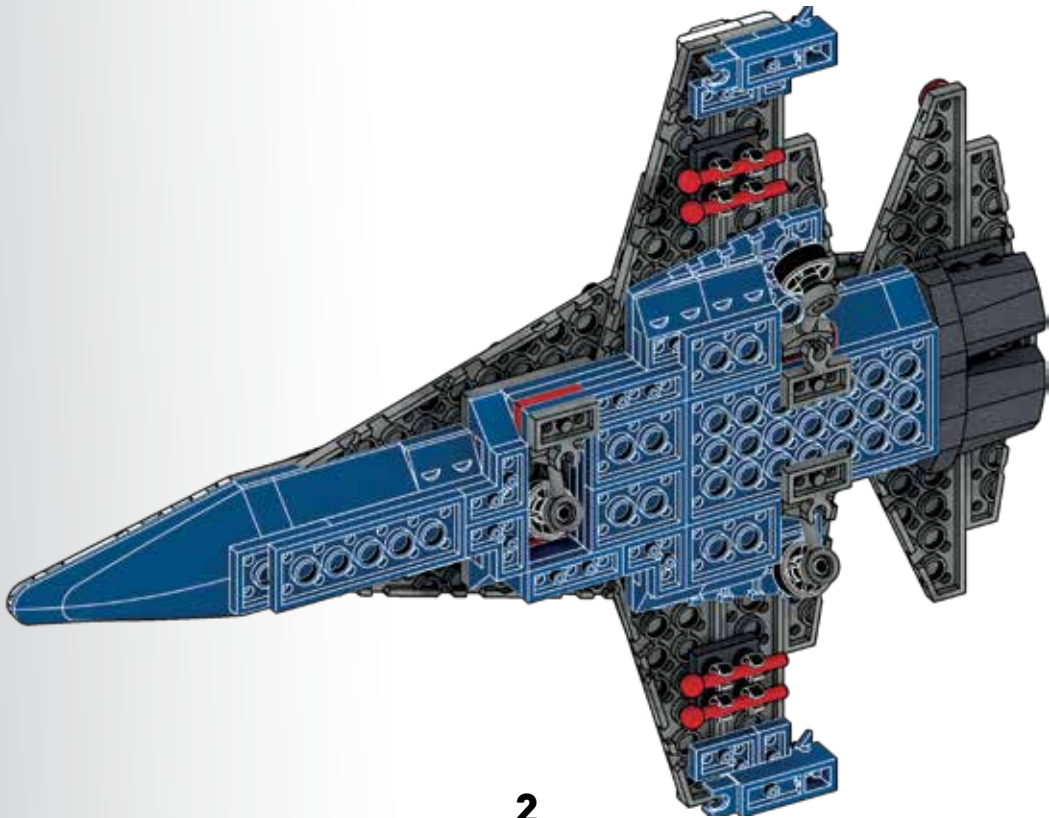

2

60



2x



1x



1x



1x

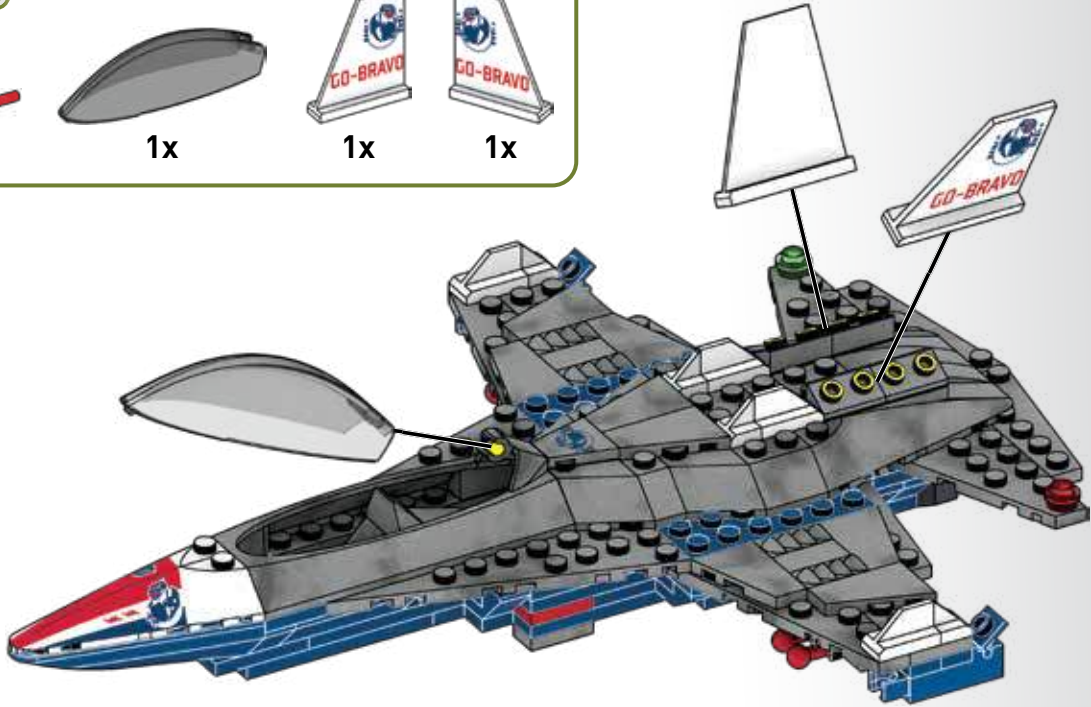

1

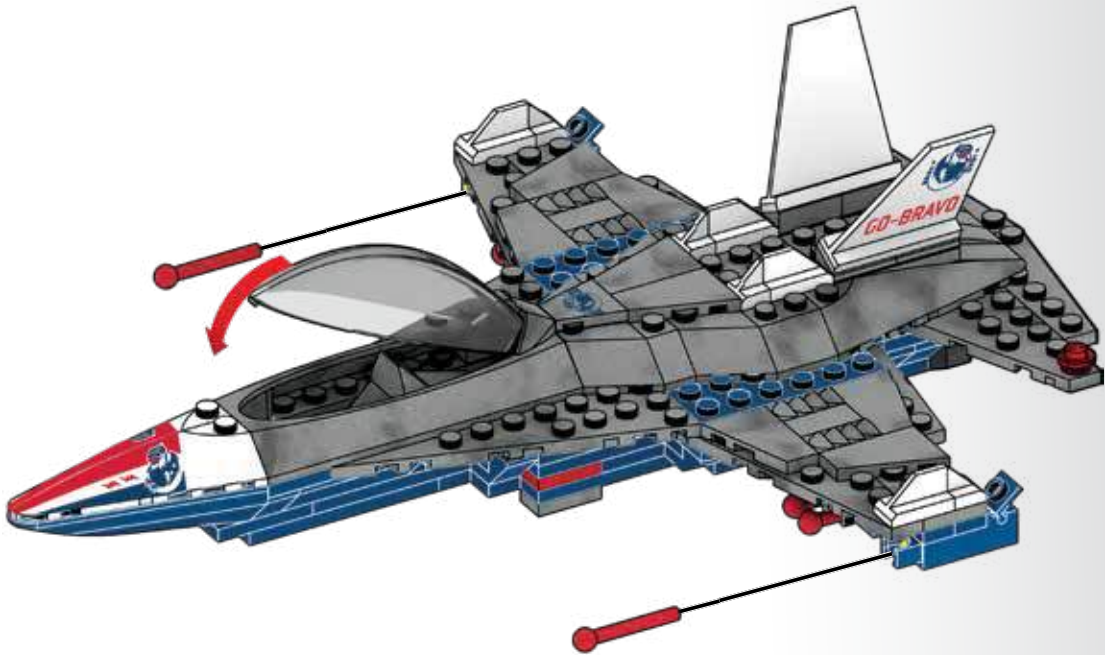

2



**1**

2x 1x

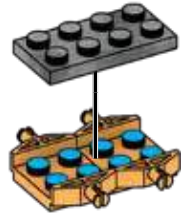

**2**

1x 1x



**3**

2x 1x 1x

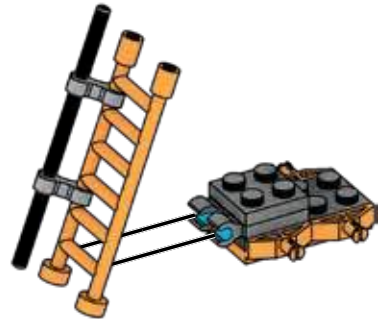
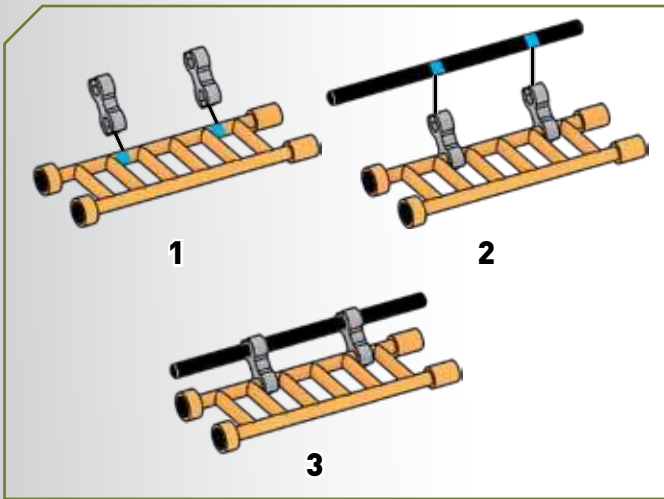

**4**

4x

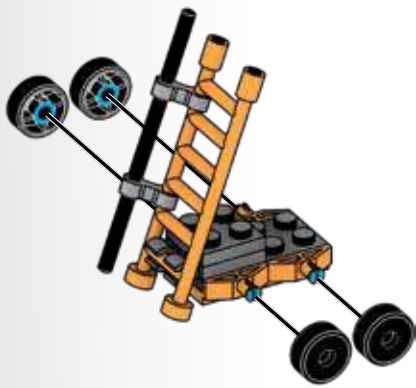

1



2

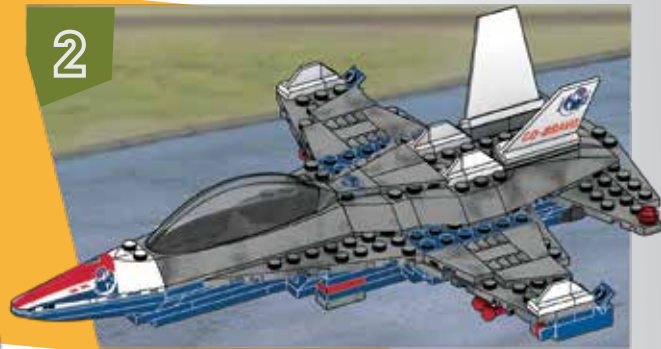
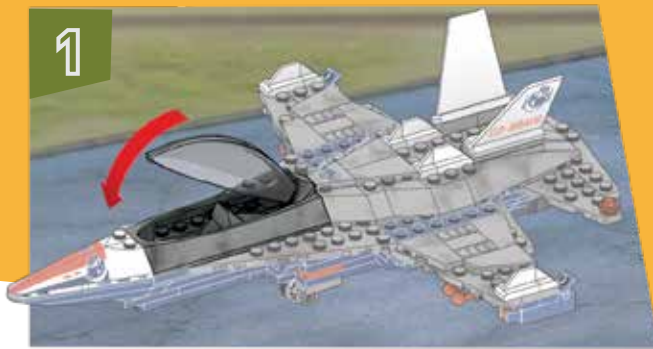

Warning: Do not aim at eyes or face. Only use projectiles supplied with this toy. Do not fire at point blank range. / Attention : Ne pas viser les yeux ou le visage. Ne pas utiliser d'autres projectiles que ceux fournis avec ce jouet. Ne pas tirer à bout portant. / Advertencia: No apuntar hacia los ojos o la cara. Utilizar exclusivamente los proyectiles suministrados con este juguete. No disparar a quemarropa. / **ATENÇÃO!** Não apontar em direção aos olhos ou ao rosto. Usar apenas os projéteis fornecidos com este brinquedo. Não disparar à queima-roupa. / Avvertenza: Non mirare agli occhi o al viso. Usare solo i proiettili forniti con il giocattolo. Non sparare a distanza ravvicinata. / Achtung: Nicht auf Augen oder Gesicht zielen. Nur die zu diesem Spielzeug gehörenden Projektile verwenden. Nicht auf Menschen oder Tiere oder aus nächster Nähe zielen. / Ostrzeżenie: Nie celuj w oczy i twarz. Nie strzelaj pociskami innymi niż dostarczone z zabawką. Nie strzelaj z bliska. / Waarschuwing: niet op ogen of gezicht richten. Gebruik uitsluitend de bijgeleverde projectielen. Niet van te dichtbij afschieten. / Предупреждение: Не направляйте в глаза или лицо. Используйте только снаряды, входящие в комплект. Не стреляйте со слишком близкого расстояния. / Advarsel: Sigtt ikke mod øjne eller ansigt. Brug kun de projektiler, som følger med legetøjet. Skyd ikke direkte på personer eller ting. / Varning: Sikta inte mot ögon eller ansikte. Använd endast projektiler som medföljer leksaken. Fyra inte av på mycket nära håll. / Advarsel: Du må ikke sikte mot øyne eller ansikt. Bruk bare prosjektilene som følger med leken. Ikke skyt på noe på kloss hold. / Varoitus: Älä tähtää silmiin eikä kasvoihin. Käytä ainoastaan tämän tuotteen mukana tulleita ammuksia. Älä ammu lähietäisyydeltä. / Προσοχή: Μην στοχεύετε στα μάτια ή στο πρόσωπο. Χρησιμοποιείτε μόνο τα βλήματα που περιλαμβάνονται. Μην στοχεύετε όταν δεν έχετε ορατότητα. / Uyari: Göze veya yüze nişan almayın. Fırlatmak için yalnızca bu oyuncakla birlikte verilen objeleri kullanın. İnsanlara ve hayvanlara nişan almayın. / Upozornění: Nemířte na oči nebo na obličej. Používejte pouze projektily dodávané s touto hračkou. Nestřelujte z bezprostřední blízkosti. / Upozornenie: Nemierite do očí ani do tváre. Používajte iba strely dodané spolu s touto hračkou. Nestrielajte z bezprostrednej blízkosti. / Figyelmeztetés: Tilos szemre és arcra célozni. Kizárólag a játékhoz mellékelt lövedékeket használja. A játékkal tilos közvetlen közelről lőni. / 警告： 目や顔を狙わないでください。 このおもちゃに同梱されている発射物のみ使用するようにしてください。 到達可能な距離内で火を燃やさないでください。

تحذير: يجب عدم التصويب باتجاه العينين أو الوجه. يجب استخدام المقذوفات المزودة مع هذه اللعبة فقط. يجب عدم الإطلاق من مدى قريب.  
**警告： 请勿对着眼睛或脸部发射。 仅使用本玩具自带的抛射物。 请勿近距离射击。**

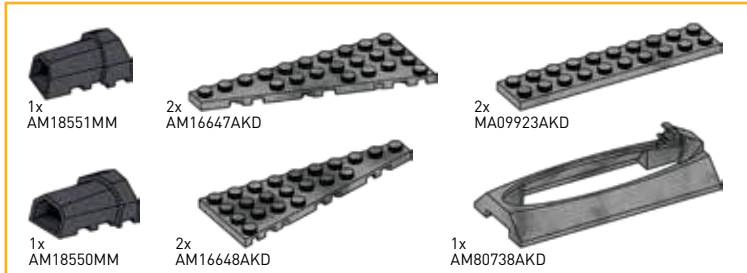
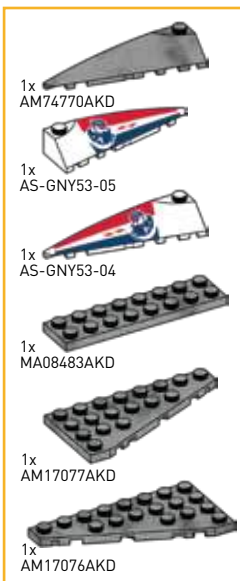
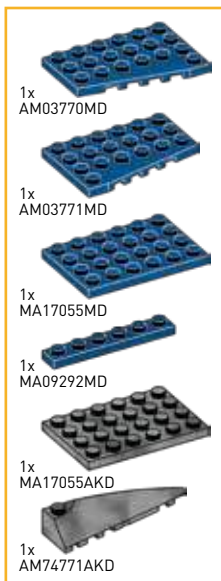

Mattel Europa B.V., Gondel 1, 1186 MJ Amstelveen, Nederland. Mattel U.K. Limited, The Porter Building, 1 Brunel Way, Slough SL1 1FQ, UK. Mattel France, Parc de la Cerisaie, 1/3/5 allée des Fleurs, 94260 Fresnes Cedex. N° Cristal 0969 36 99 99 (Numéro non surtaxé) ou www.lesjouetsmattel.fr. Mattel Belgium, Trade Mart, Atomiumsquare, Bogota 202 - B 275, 1020 Brussels. Grátis number België: 0800 - 16 936 - Grátis number Luxembourg: 800 - 22 784 - Grátis number Nederland: 0800 - 262 88 35. Deutschland: Mattel GmbH, Solmsstraße 4, D-60486 Frankfurt am Main. Schweiz: Mattel AG, Kirchstrasse 24, CH-3097 Liebefeld. Österreich: Mattel Ges.m.b.H., Campus 21, Liebermannstraße A01 404, A- 2345 Brunn/Gebirge. Mattel Italy Srl, Via Bracco, 6-MAC 6, 20159 Milano, Italy. Servizio assistenza clienti: Customersrv.italy@mattel.com - Numero verde 800 11 37 11. Mattel España, S.A., Arbau 200, 08036 Barcelona. cservicio.spain@mattel.com.Tel: 902203010 http://www.service.mattel.com/es. Mattel East Asia Ltd., Room 503-09, North Tower, World Finance Centre, Harbour City, Tsimshatsui, HK, China. Tel.: (852) 3185-6500. Diimport & Diedarkan Oleh: Mattel Continental Asia Sdn Bhd. Level 19, Tower 3, Avenue 7, No. 8 Jalan Kerinchi, Bangsar South, 59200 Kuala Lumpur, Malaysia. Mattel South Africa (PTY) LTD, Office 102 B, 30 Melrose Boulevard, Johannesburg 2196. Dystrybutor: Mattel Poland Sp. z o.o., Warsaw Trade Tower 34 p., ul. Chłodna 51, 00-867 Warszawa. Mattel Australia Pty. Ltd., 658 Church St., Richmond, Victoria, 3121. Consumer Advisory Service - 1300 135 312. Mattel AEBE, Εθνάρχου Μακαρίου 1, Κηρίο Κ-2, ΤΚ 17561, Παλαιό Φάληρο. Mattel Oyuncakçılık Tic. Ltd. Şti. İçerenköy Mah., Erkut Sok. A Blok No:12 Üner Plaza Kat:9-10 34752 Ataşehir İstanbul. Tel: 0216 570 75 00. Импортер/Уполномоченная организация: ООО "МАТЕЛ" Российская Федерация, 105120 Москва, 2-й Сыромятнинский переулок 1; +7 495 287 79 39. Forg.: Mattel Toys Hungary Kft 1139 Budapest Váci út 91. +36 1 270 0223. Mattel Czech Republic s.r.o., The Forum, Václavské nám. 19, 11000 Praha1. Mattel, Inc. 636 Girard Avenue, East Aurora, NY 14052, U.S.A. Mattel Canada Inc., Mississauga, Ontario L5R 3W2. Consumer Services: You may call us free at/ Composez sans frais le 1-800-524-8697. Importado y distribuido por Mattel de México, S.A. de C.V., Miguel de Cervantes Saavedra No. 193, Pisos 10 y 11, Col. Granada, Alcatraz Miguel Hidalgo, C.P. 11520, México, Ciudad de México. R.F.C. MME-920701-NB3. Tels: 59-05-51-00 Ext. 5206 01-800-463-59-89. Mattel Chile, S.A., Avenida Américo Vespucio 501-B, Quilicura, Santiago. Tel: 1230-020-6213. Servicio al consumidor Venezuela: Tel: 0-800-100-9123. Mattel Argentina, S.A., Av. Libertador 1000, Piso 11 - Oficinas 109 y 111, Vicente López - Prov. Buenos Aires. Tel: 0800-666-3373. Mattel Colombia, S.A., Calle 123#7-07 P5, Bogotá. Tel: 01800-710-2069. Mattel Perú, S.A., Av. Juan de Arona # 151, Centro Empresarial Juan de Arona, Torre C, Piso 7, Oficina 704, San Isidro, Lima 27, Perú. RUC: 20425853865. Reg. Importador: 02350-12-JUE-DIGESA. Tel: 0800-54744. E-mail Latinoamérica: servicio.clientes@mattel.com. Mattel do Brasil Ltda.- CNPJ : 54.558.002/0001-20 - Rua Verbo Divino, 1488 - 2º. Andar - 04719-904 - Chácara Santo Antônio - São Paulo - SP - Brasil. Serviço de Atendimento ao Consumidor: fone 0800-550780. E-mail: sac.mattel@brasil.mattel.com

Kampffjet / истребитель / jet caccia / straaljager / Stridsflygplan / kampfly / myśliwiec / stihací letoun / bojová stíhačka / harci repülő / μαχητικό τζετ / savas jeti / jet لاقولجا



⚠ WARNING: CHOKING HAZARD. - Small parts. Not for children under 3 years.  
 ⚠ ATTENTION: DANGER D'ÉTOUFFEMENT. - Présence de petits éléments. Ne convient pas aux enfants de moins de 3 ans.  
 ⚠ 警告: のどにつまる危険 小さな部品が含まれています 3歳以下の子供には与えないで下さい。  
 ⚠ تحذير: غير مناسبة للأطفال دون 36 شهراً - قطع صغيرة.  
 ⚠ 警告! 不适合3岁以下儿童使用。内含小零件。

ADVERTENCIA: PELIGRO DE ATRAGANTAMIENTO. Juguete no recomendado para menores de 3 años, porque contiene piezas pequeñas que podrían provocar asfixia en caso de ser ingeridas o inhaladas por el/ la niño/a.  
 ATENÇÃO! Não indicado / não recomendável para crianças menores de 3 (três) anos por conter parte(s) pequena(s) que pode(m) ser engolid(a)s ou aspirada(s) podendo provocar asfixia.  
 AVVERTENZA: Contiene pezzi di piccole dimensioni.  
 ACHTUNG: Kleine Teile.  
 OSTRZEŻENIE: Małe części. Niebezpieczeństwo zadławienia.  
 WAARSCHUWING: Kleine onderdelen  
 ПРЕДУПРЕЖДЕНИЕ: Мелкие детали.  
 ADVARSEL: Indeholder små dele.  
 VARNING: Smådelar  
 ADVARSEL: Små deler  
 VAROITUS: Pieniä osia  
 ΠΡΟΣΟΧΗ: Περιλαμβάνονται μικρά κομμάτια.  
 UYARI: Küçük parçalar.  
 UPOZORNENIE: Malé diely  
 UPOZORNENIE: Malé části  
 FIGYELMEZTETÉS: Kis alkatrészek.



**MEGA**<sup>TM</sup>  
**CONSTRUX**

More to collect!  
Encore plus à collectionner!  
Más para coleccionar! / Mais para  
Colecionar! / Mehr zum Sammeln! /  
Собери больше!



GNY55\*

GNY56\*



**BUILD & SHARE**  
**CONSTRUIRE ET PARTAGER**  
CONSTRUYE Y COMPARTE | MONTAR E  
COMPARTILHAR | BAÜEN UND MIT  
ANDEREN TEILEN | СОЗДАВАЙ И ДЕЛИСЬ  
[play.megaconstrux.com](http://play.megaconstrux.com)

\*Each sold separately and subject to availability. / Produits vendus séparément, selon la disponibilité. / Se venden por separado y están sujetos a disponibilidad. / Vendidos em separado e sujeitos à disponibilidade. / Ognuno in vendita separatamente secondo disponibilità. / Alle Artikel separat erhältlich. Einige Artikel werden nicht in allen Ländern vertrieben. / Sprzedawane oddzielnie w zależności od dostępności. / Per stuk verkrijgbaar en niet overal leverbaar. / Каждый продукт продается отдельно, в зависимости от наличия. / Sælges separat og så længe lager haves. / Alla delar säljs separat så långt lagret räcker. / Hver leke selges separat så langt lageret rekker. / Jokainen myydään erikseen, saatavuus voi vaihdella. / Το καθένα πωλείται ξεχωριστά και ανάλογα με τη διαθεσιμότητα. / Her biri ayrı ayrı ve stoklara bağlı olarak satılır. / Každá hračka se prodává samostatně dle aktuální nabídky. / Každé sa predáva samostatne a podľa dostupnosti. / Mindegyik külön kapható, elérhetőségük változhat. / それぞれ在庫状況に従って個別に販売されます。 / تباع كل منها على حدة وتخضع لتوفره.

每件单独出售，并且视库存情况而定。



© D714,887  
1186 MJ, 1, NL



MEGA Brands Inc. Montreal QC H4T 1K4 Canada

MADE IN CANADA WITH DOMESTIC AND IMPORTED COMPONENTS. FABRIQUÉ AU CANADA AVEC DES COMPOSANTS DOMESTIQUES ET IMPORTÉS. FABRICADO NO CANADÁ COM COMPONENTES CANADIANOS E IMPORTADOS. FABRICADO EN CANADÁ CON PIEZAS FABRICADAS EN CANADÁ Y PIEZAS IMPORTADAS. ИЗГОТОВЛЕНО В КАНАДЕ С ОТЕЧЕСТВЕННЫМИ И ИМПОРТНЫМИ КОМПОНЕНТАМИ. YERLI VE İTHAL PARÇALARLA KANADA'DA ÜRETİLMİŞTİR.  
صنع في كندا من مواد محلية ومستوردة.

©2019, MEGA Brands Inc. & <sup>TM</sup> MEGA Brands Inc. CONSTRUX<sup>TM</sup> is owned by Mattel and used under license. CONSTRUX<sup>TM</sup> appartient à Mattel et est utilisée sous licence.  
Printed in Canada / Imprimé au Canada D-GNY53-01

**10+**  
**PRO**  
BUILDERS<sup>TM</sup>

Are you ready for the  
next challenge?  
Es-tu prêt pour le  
défi suivant?

¿Estás listo para el siguiente desafío?  
Você está pronto para o próximo desafio?  
Bist du bereit für die nächste Herausforderung?  
Вы готовы к следующему испытанию?

