



Refer to numbers on parts and contents page to help with assembly.

Animated assembly instructions available online! Go to:
http://www.hotwheels.com/H2247_GorillaAttack



FINAL ASSEMBLY

NOT FOR USE WITH SOME HOT WHEELS® VEHICLES.

SAFETY NOTE: Do not launch cars until toy is completely assembled.

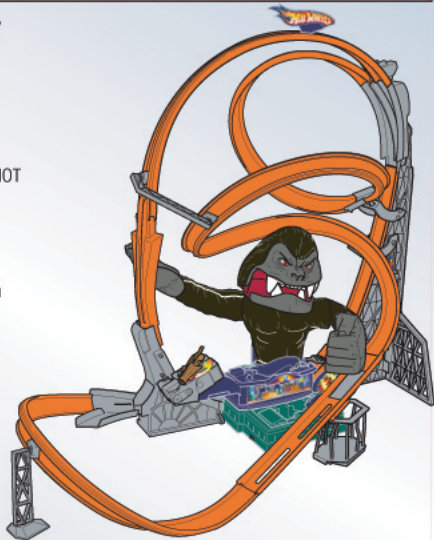

1 INSTALL BATTERIES

Open battery cover and insert 4 "D" size alkaline batteries (not included) as shown. For best performance, use alkaline batteries. Replace the batteries when the booster no longer propels the car through the set.

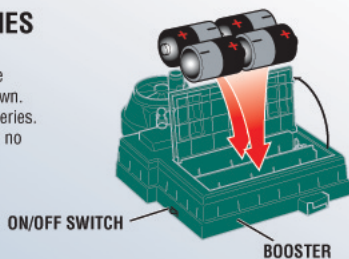

2 ASSEMBLY

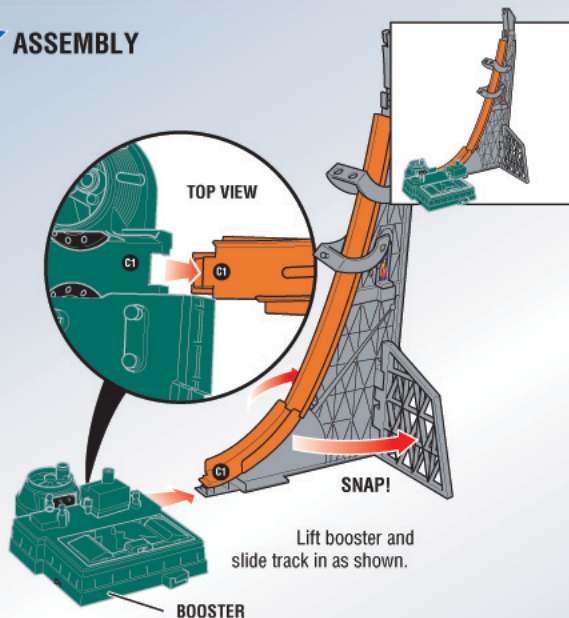

3

Lift booster and slide cage under as shown.

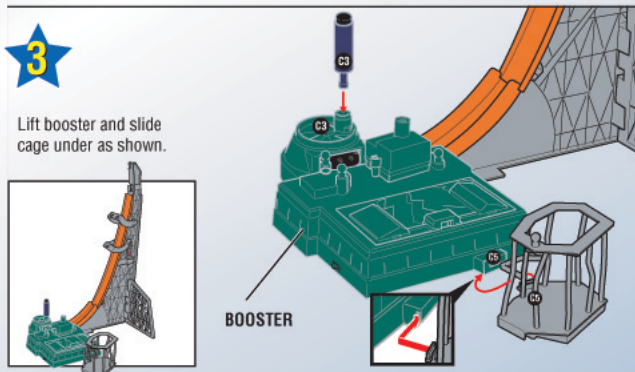

PLAY OPTION 1

Turn power switch ON. Place car on lead-in ramp and roll car into booster. The gorilla's arms will start moving. In auto mode, the gorilla's left arm will hit the lever opening and closing the trap door over the cage. Try to avoid getting caught by the gorilla's fist and dropped into the cage.

TO STABILIZE SET:
On carpet, use books. On smooth floor, tape base to surface.

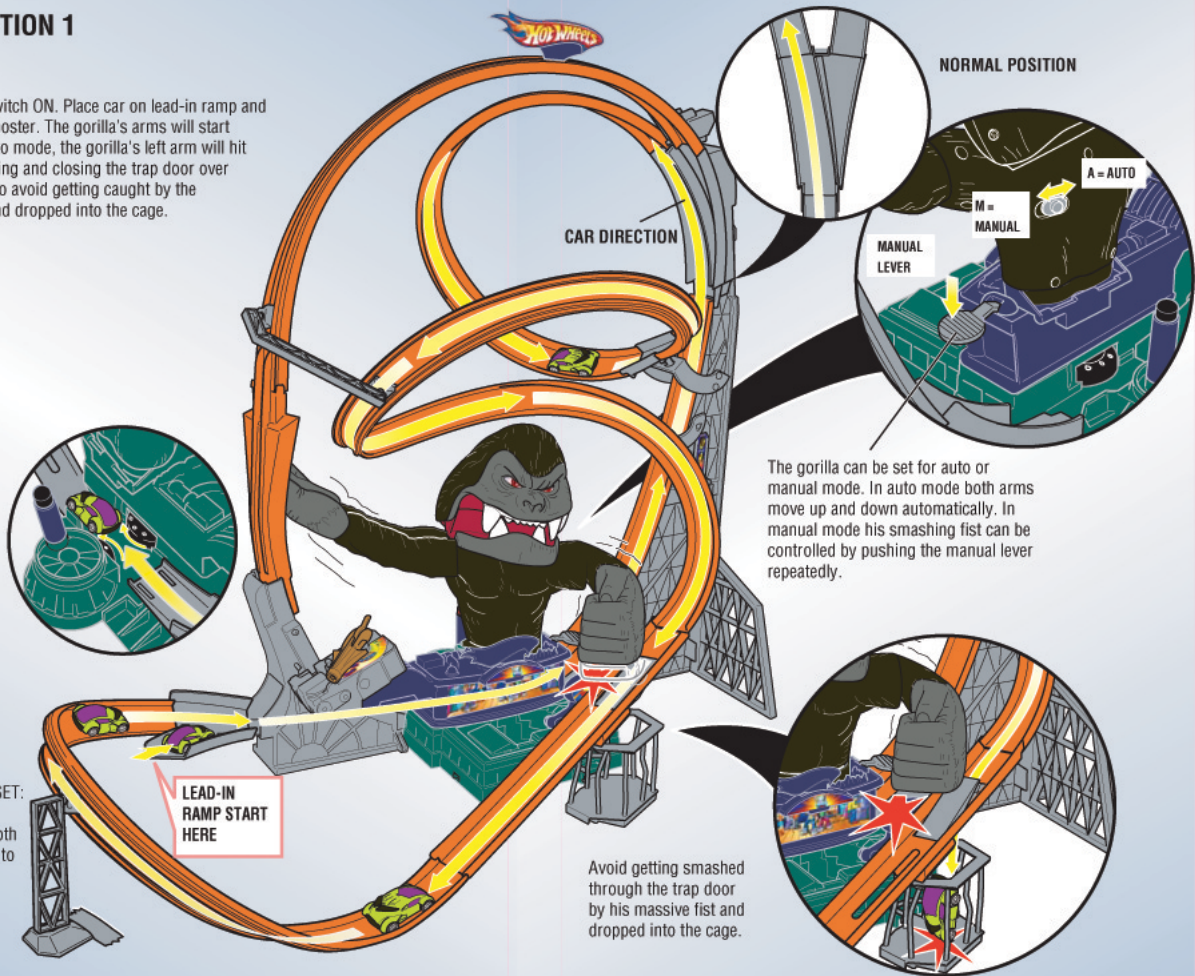

**LEAD-IN
RAMP START
HERE**

CAR DIRECTION

NORMAL POSITION

A = AUTO

**M =
MANUAL**

**MANUAL
LEVER**

The gorilla can be set for auto or manual mode. In auto mode both arms move up and down automatically. In manual mode his smashing fist can be controlled by pushing the manual lever repeatedly.

Avoid getting smashed through the trap door by his massive fist and dropped into the cage.

12

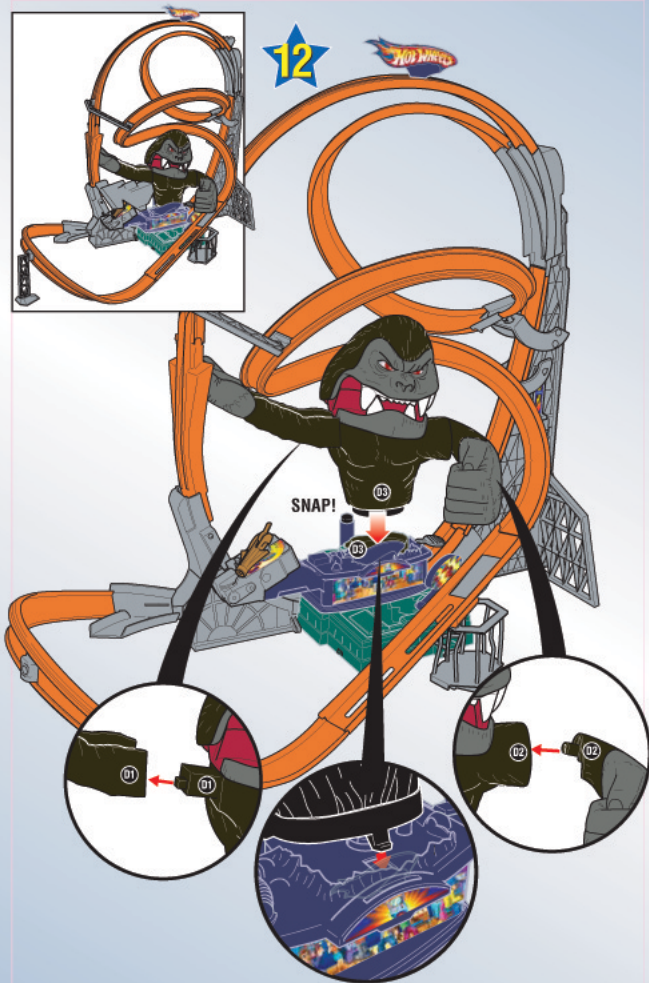

GET READY TO PLAY

Before you begin make sure that all parts and track are aligned properly and securely fastened. Insert weapon into cannon until it locks.

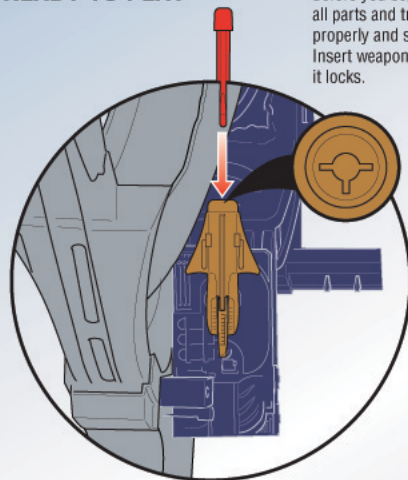

Turn cannon clockwise until it stops and locks.

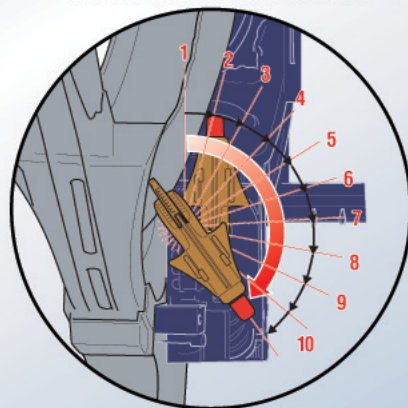

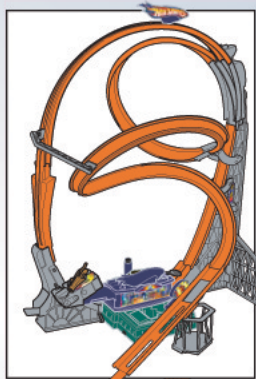

10

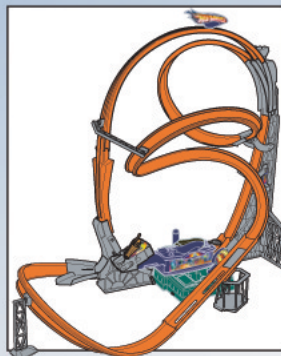
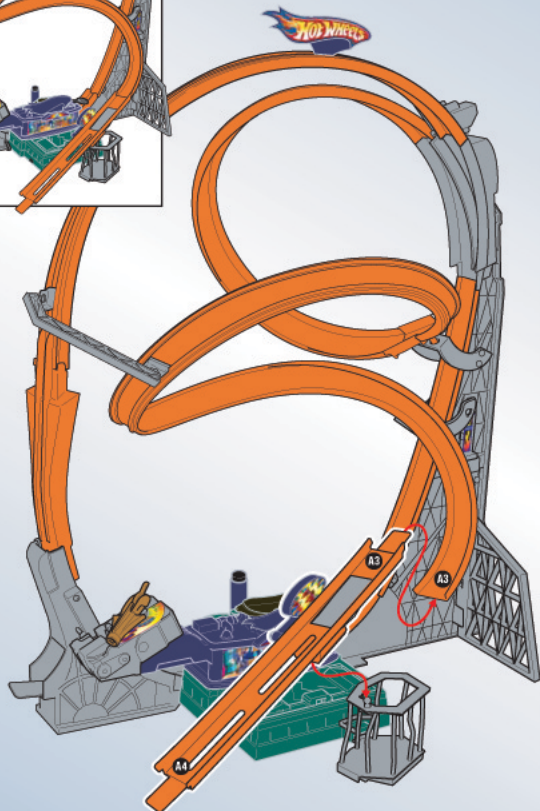

11

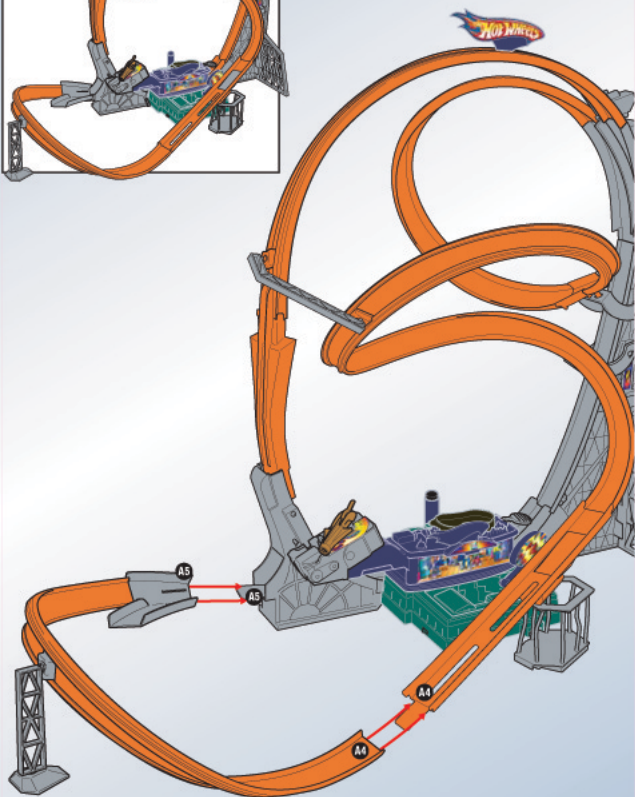

8

ADJUSTABLE

Align parts to holes in track.

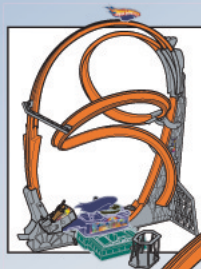
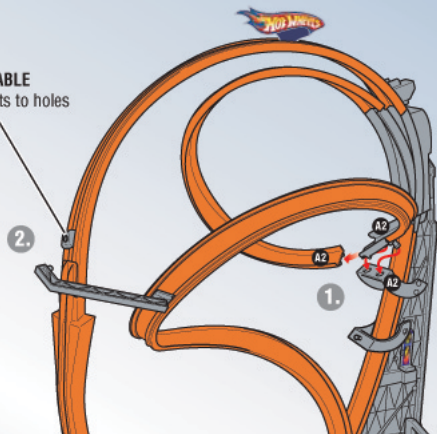

9

SIDE VIEW

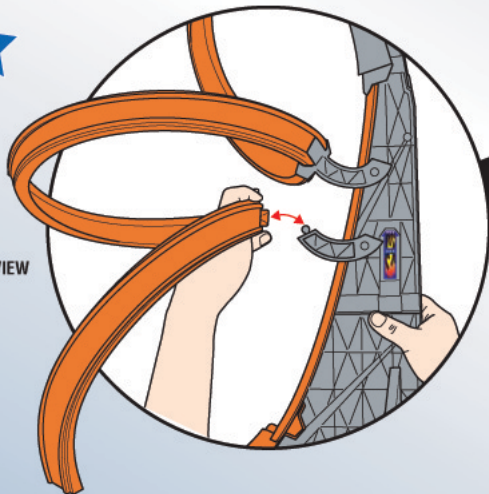

ADJUSTABLE

Align parts to holes in track.

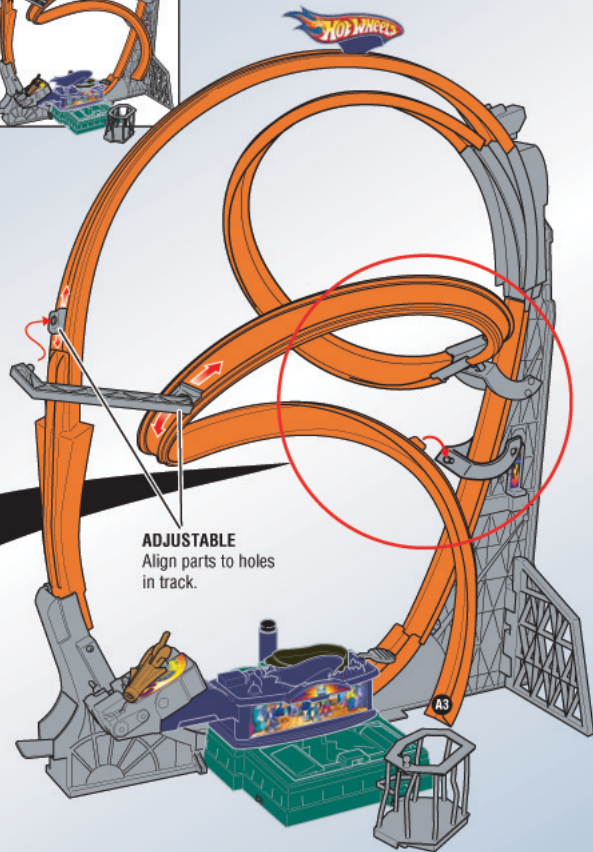

4

TOP VIEW

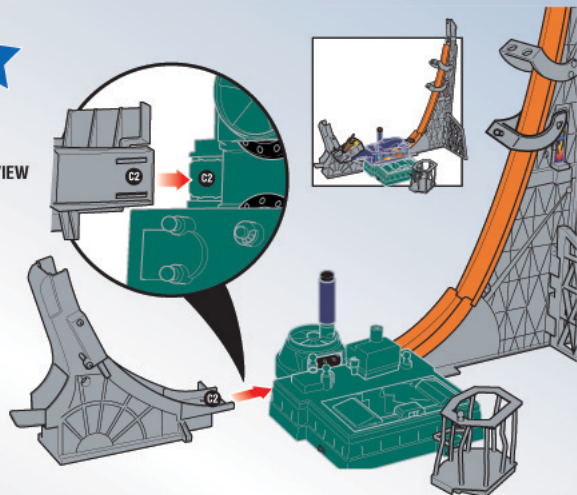

5

Attach gorilla base to booster as shown.

GORILLA BASE

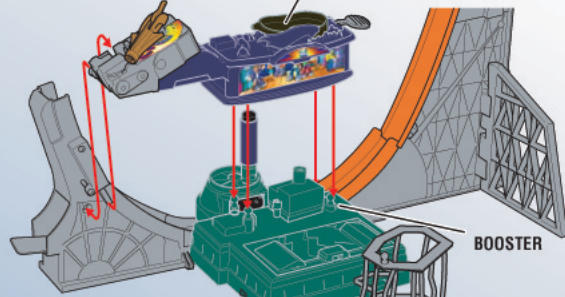

6

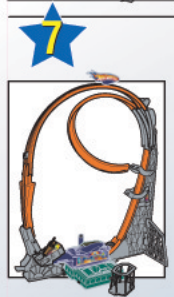

7

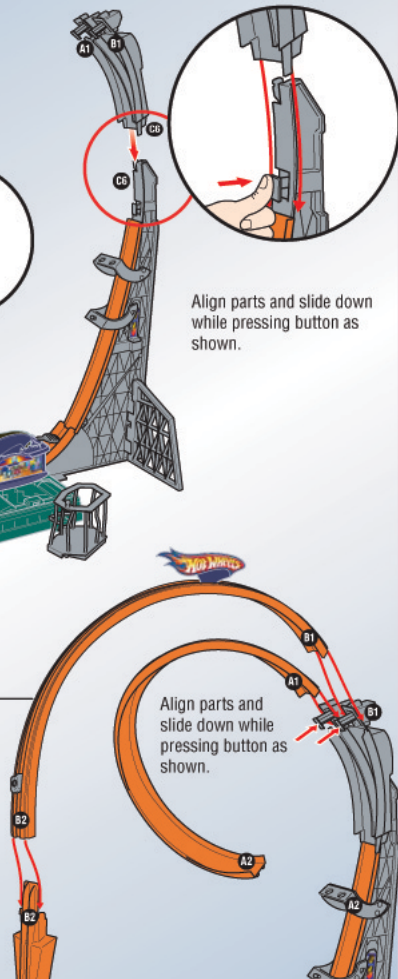

Align parts and slide down while pressing button as shown.

Align parts and slide down while pressing button as shown.

PLAY OPTION 2

Hold down the diverter lever to switch tracks. Time it right to avoid the gorilla's right hand, which will direct your car into his jaws. Each time you complete a lap, the cannon clicks one position closer to firing. The cannon will fire after 10 laps. The cannon can be set to fire between 1 and 10 laps. Just click it into desired position before you start. If the gorilla eats your car 4 times, reset the cannon and start again. If the cannon shoots and hits the gorilla he will fall back. Just reset and start again.

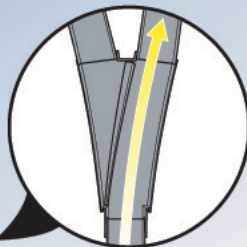
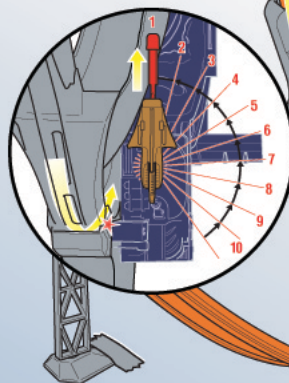

OPTION 2 POSITION

Press down diverter lever as indicated to switch tracks from normal to option 2 position.

Optional 2-Player Mode: One player can activate the car diverter and the other can activate the gorilla's smashing fist. May the best monkey win!

CAR DIRECTION

Only use projectiles supplied with this toy. Do not fire at people or animals or at point-blank range.



Shoot the gorilla and WIN!
Flip gorilla up and push it back into the base to reset and play again.