

# CALL OF DUTY

COLLECTOR CONSTRUCTION SETS

CNG85

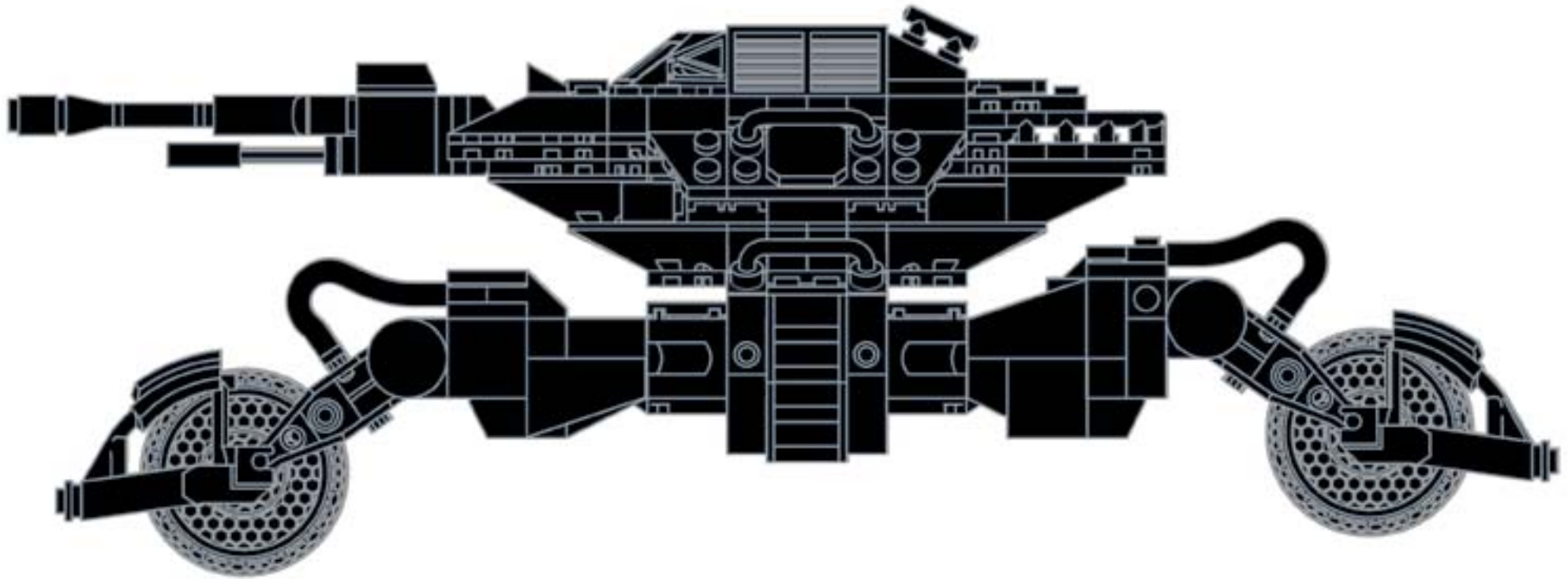

2



28



4x

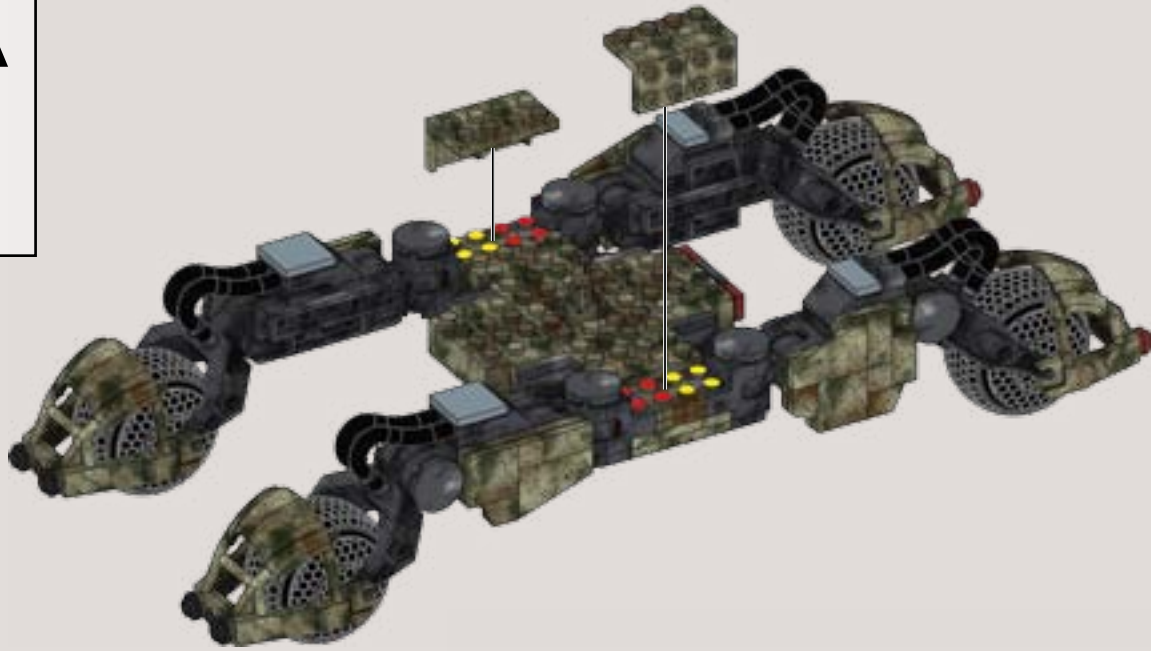

29



2x

4x

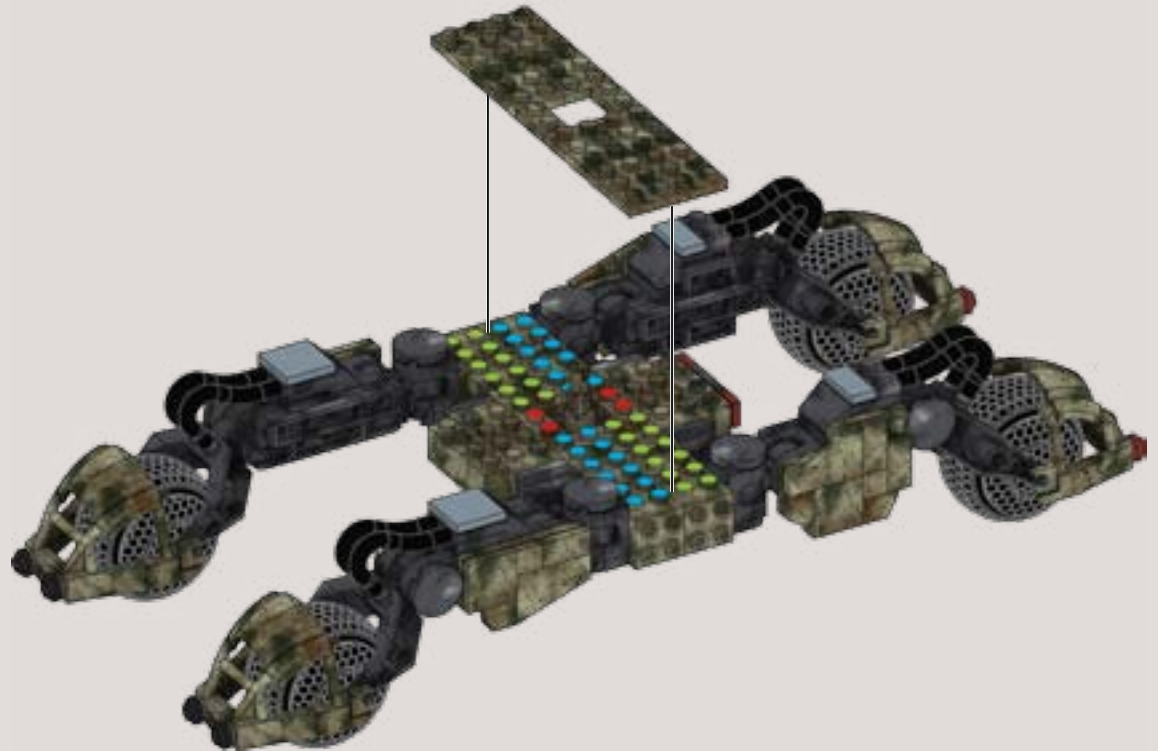

GALLERY  
COLLECTOR'S EDITION SETS

30

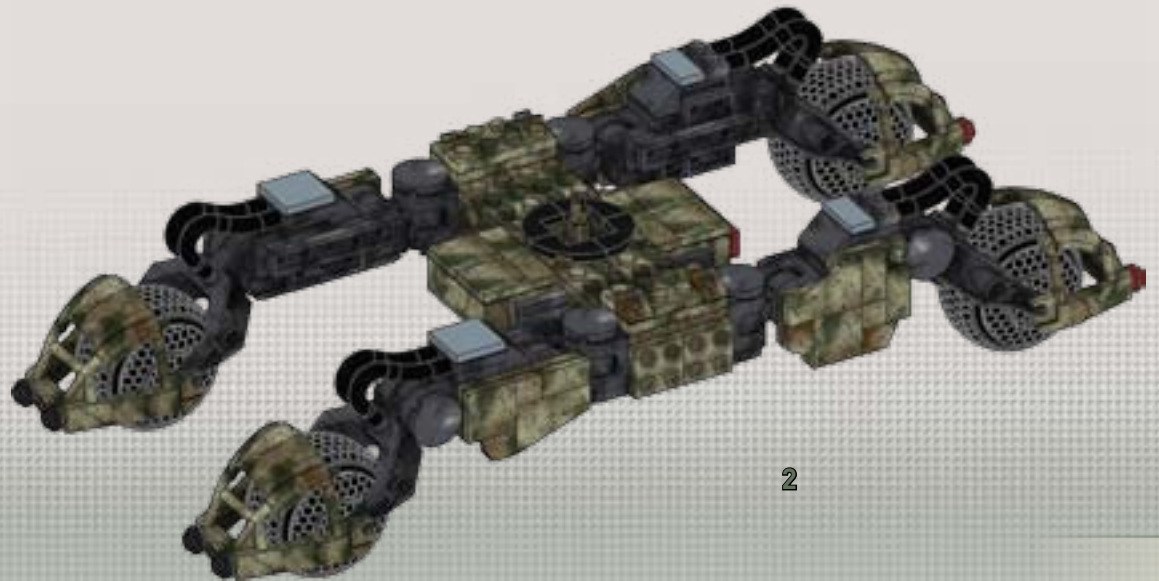
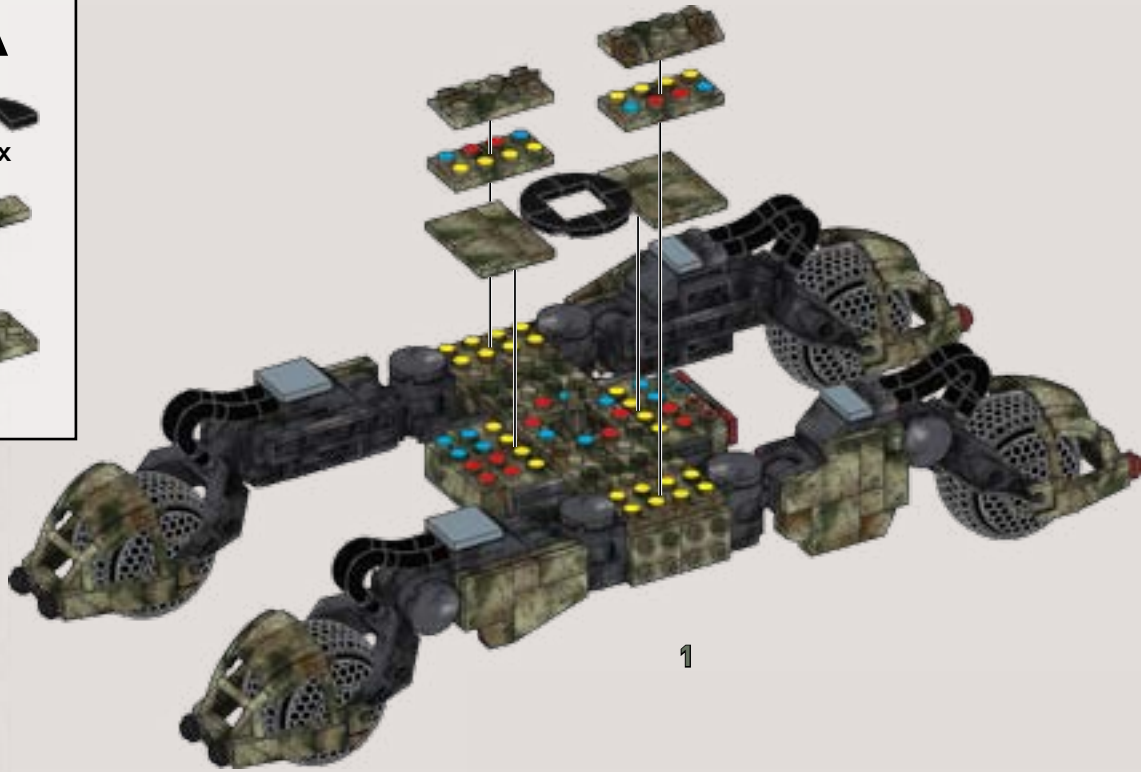

31



2x

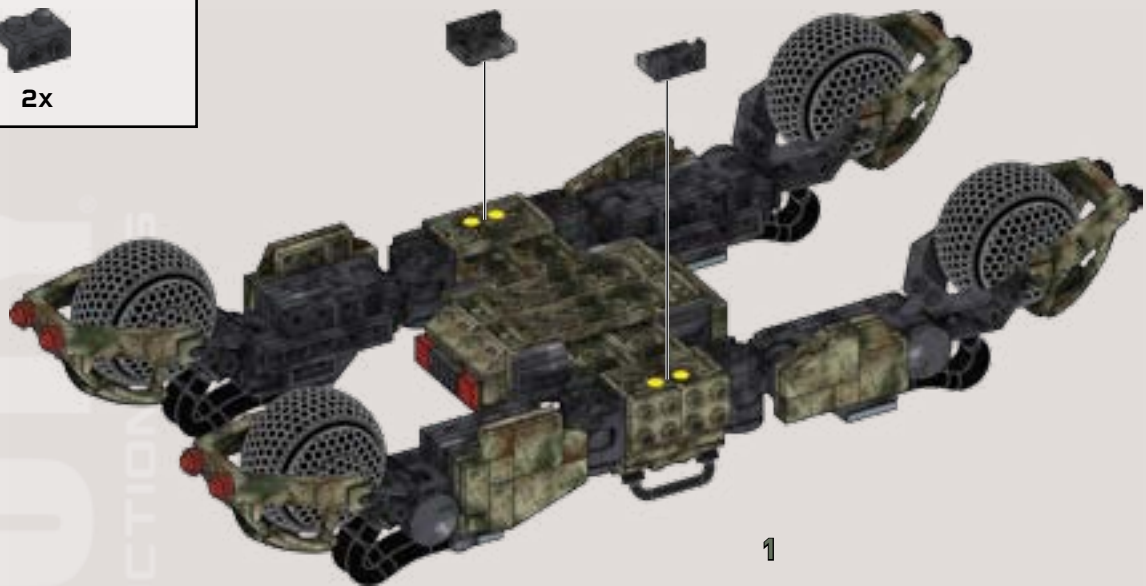

1

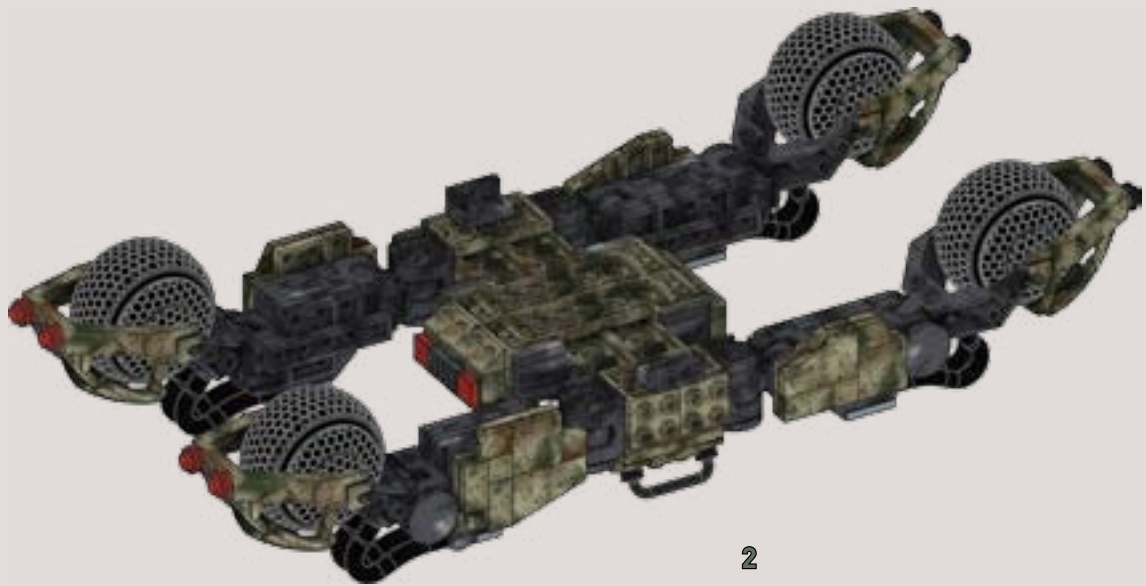

2

CALL OF DUTY  
COLLECTOR CONSTRUCTION

32



x2

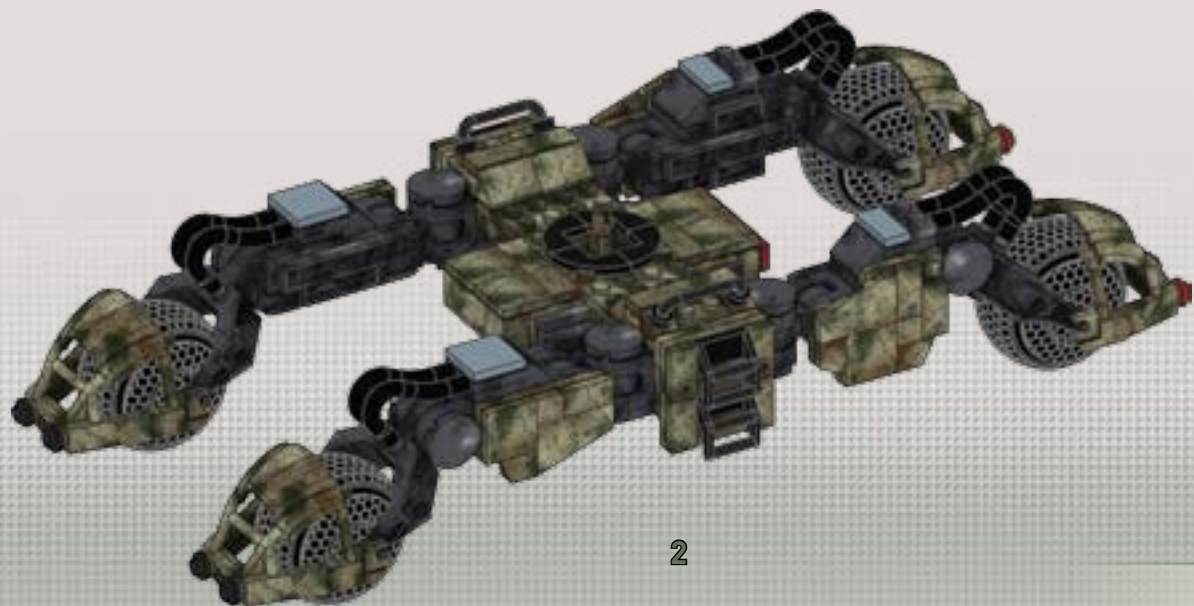
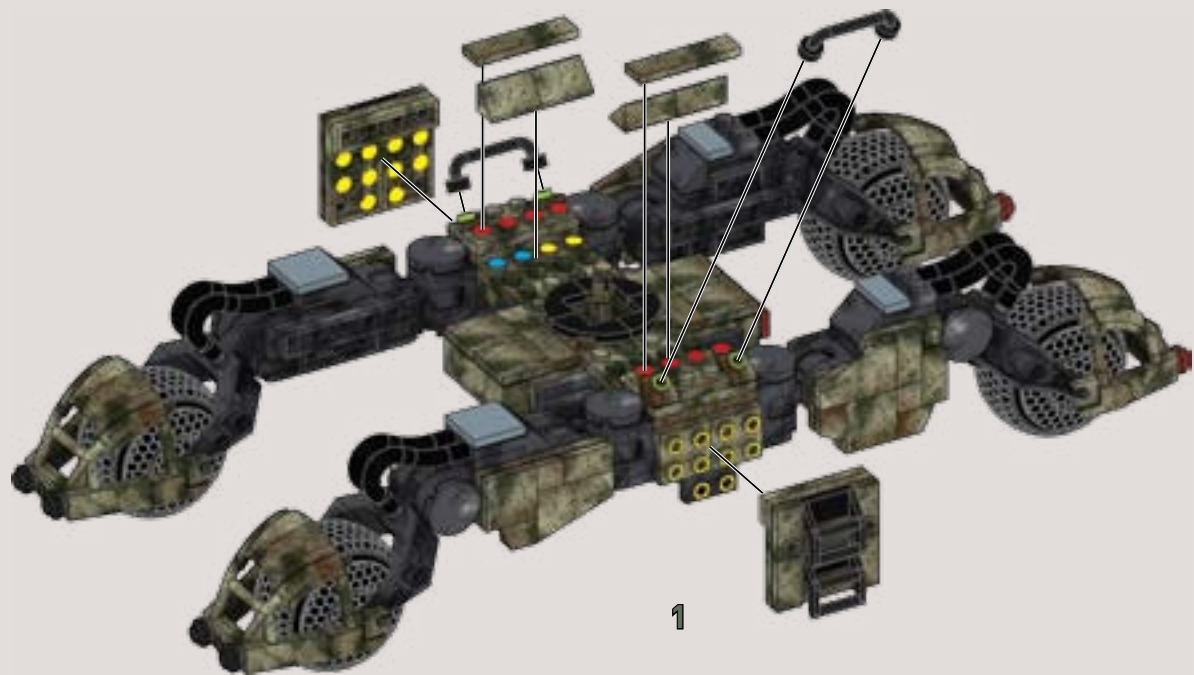
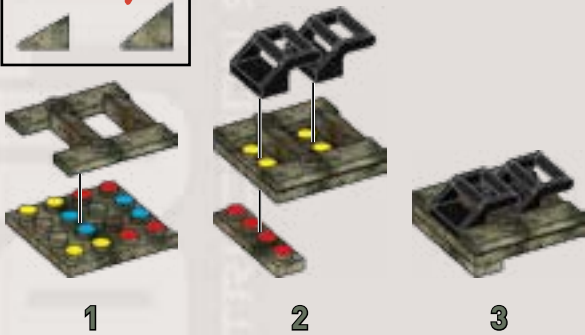



33

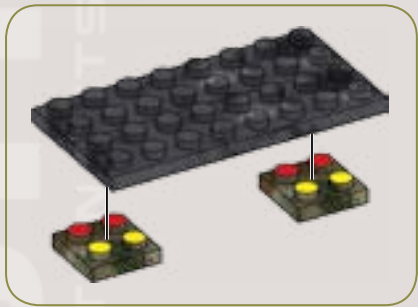

1

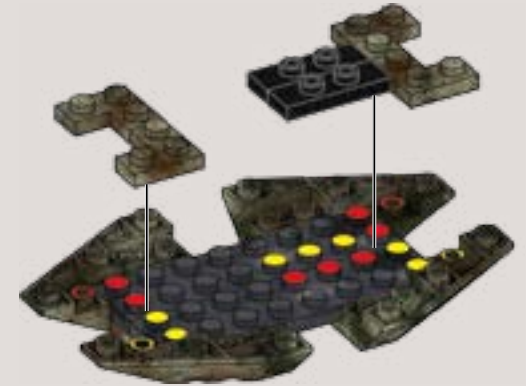

2

34



35



1



2

# 36

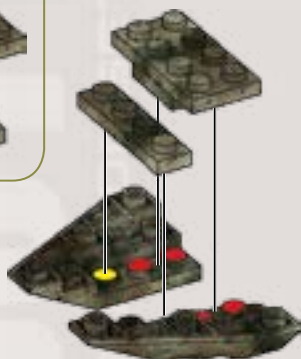

1



2

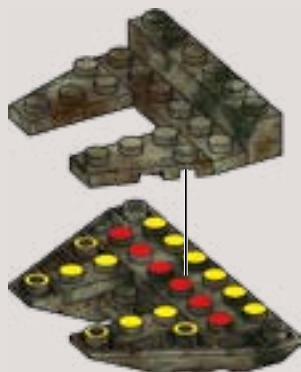

3



4



5

# 37

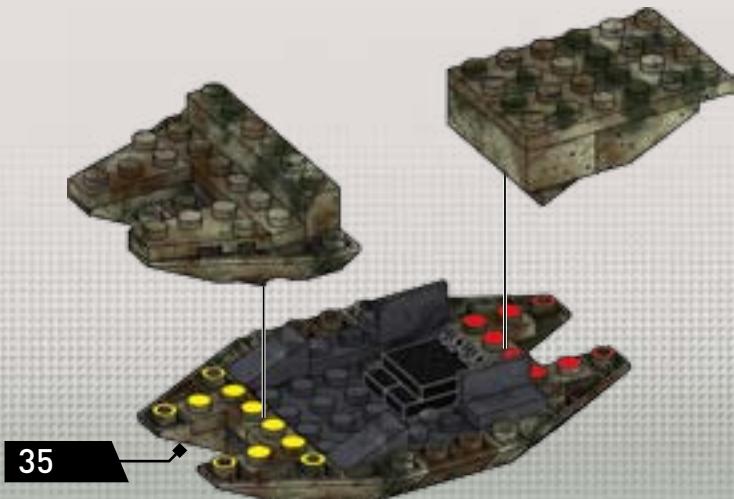
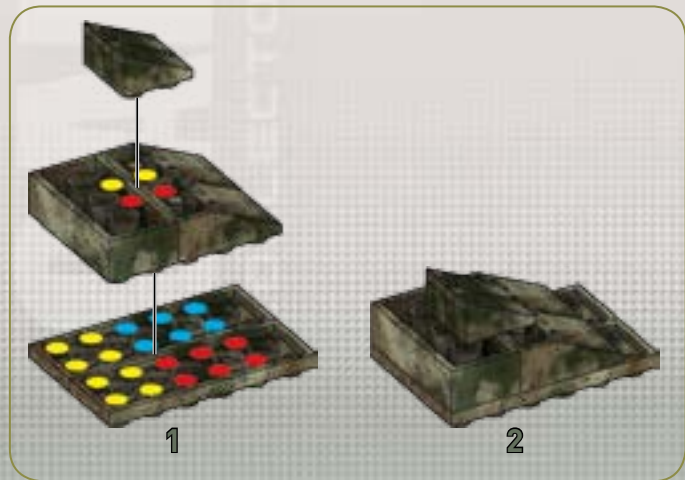

35

38

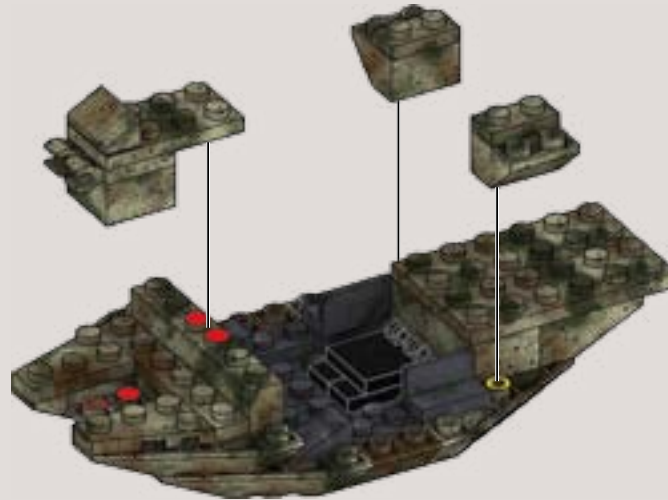

x2

39



x2





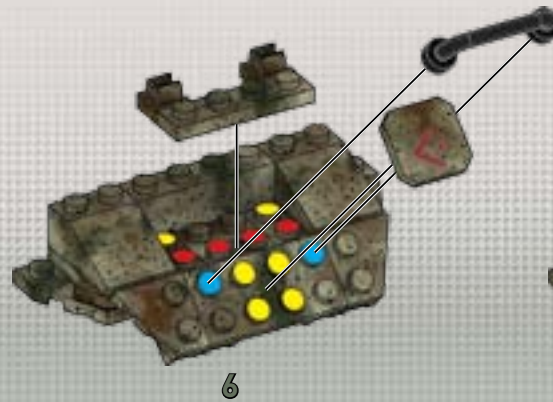
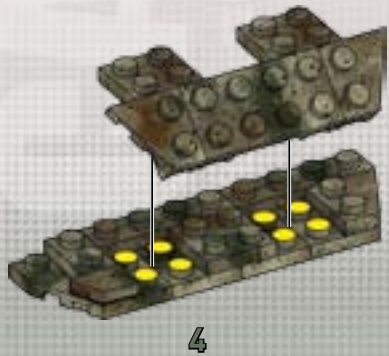
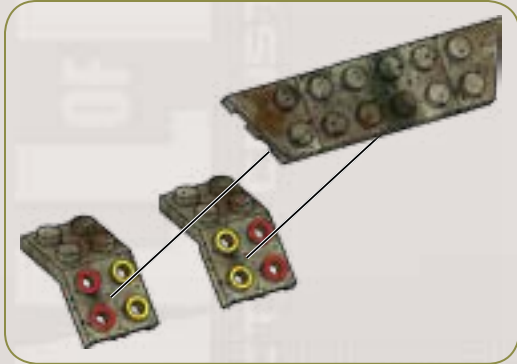
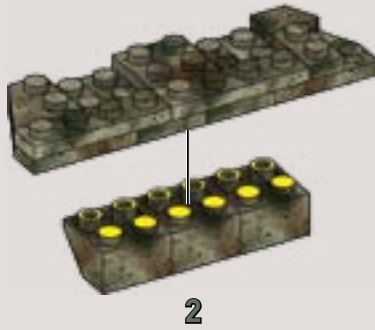
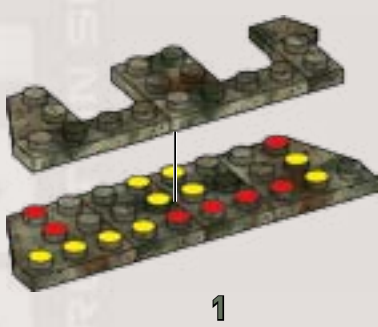

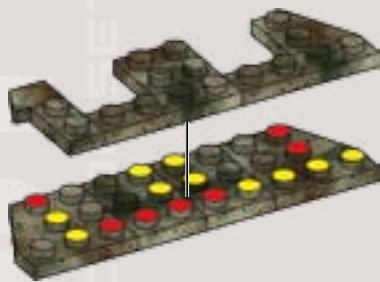

1



2



3

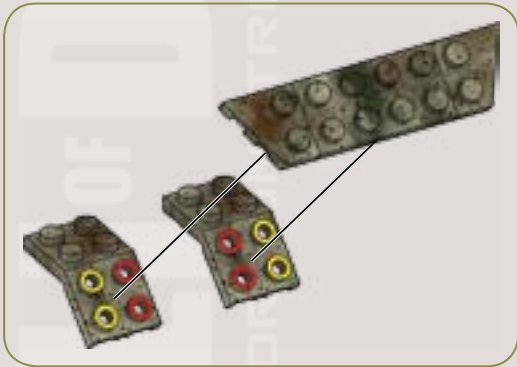

4

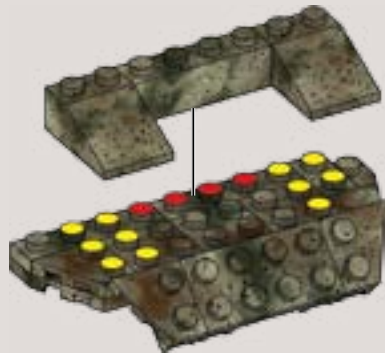

5

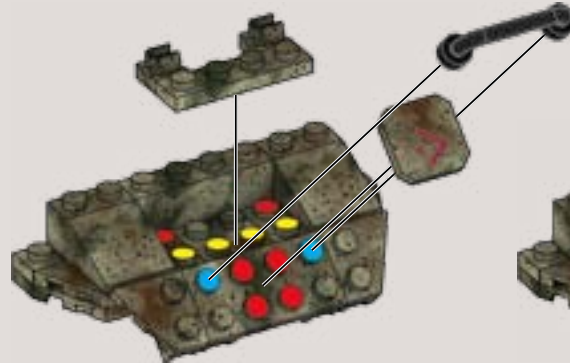

6



7



43



1



2



1



2



1



2

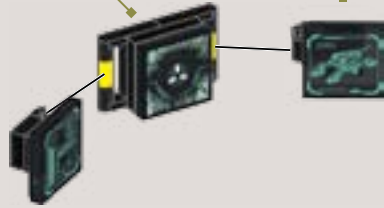

1



2



3





45

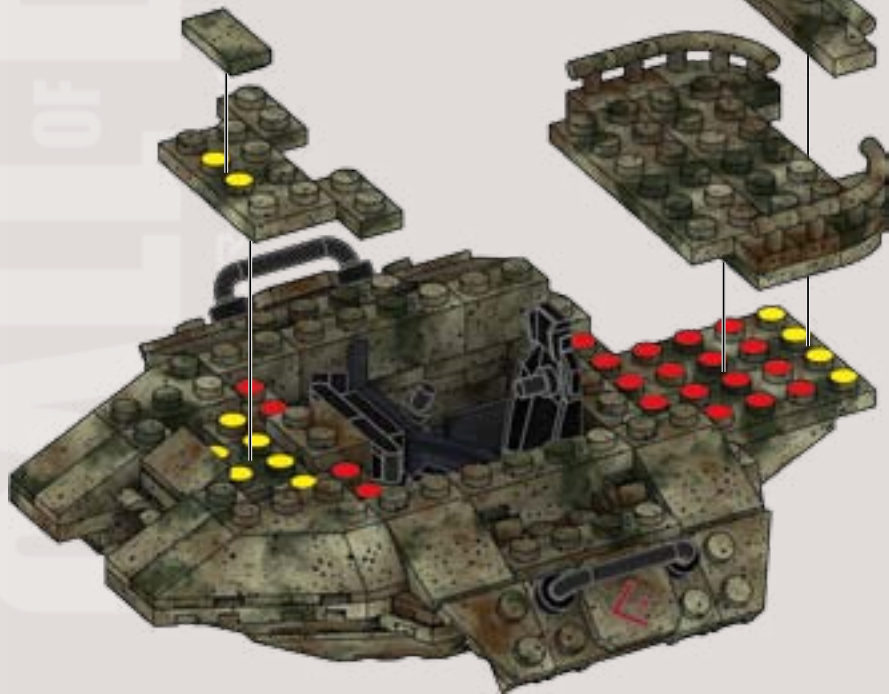

46



47



48



49

2x

1x



1



2

GALILEO COLLECTOR'S EDITION SETS



50



2x



2x



2x



2x



1x



1

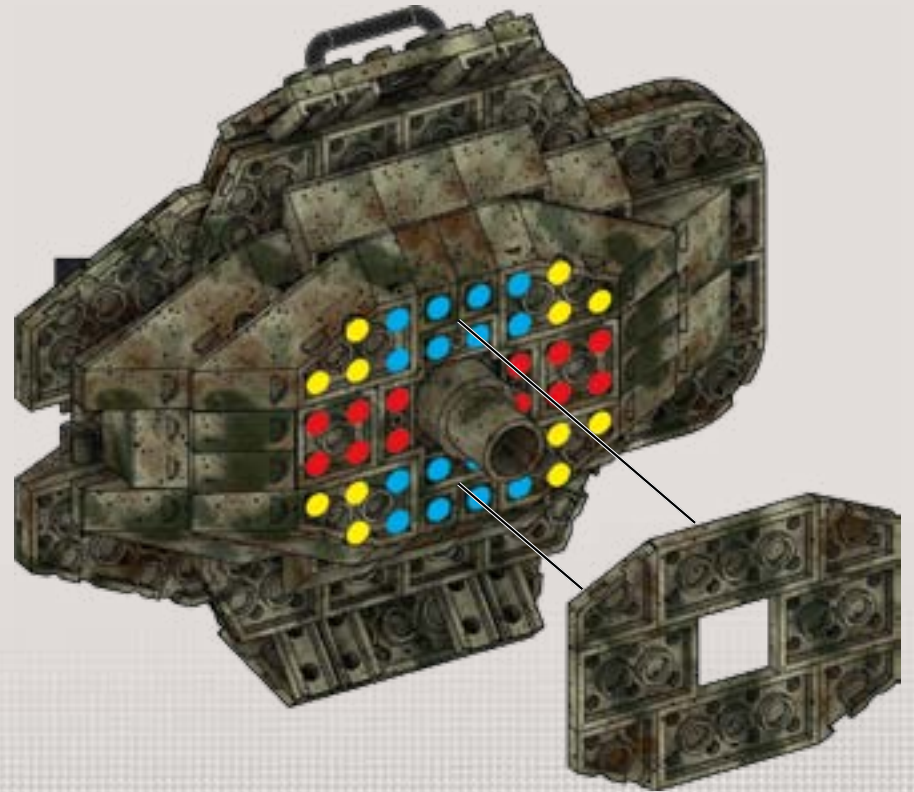

2

51



2x



2x



2x



4x

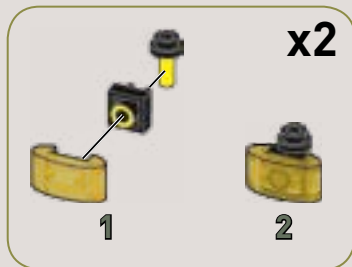

- 4x
- 2x
- 1x
- 1x
- 1x
- 1x
- 1x
- 1x
- 1x
- 1x
- 1x
- 1x
- 1x
- 1x
- 1x
- 1x

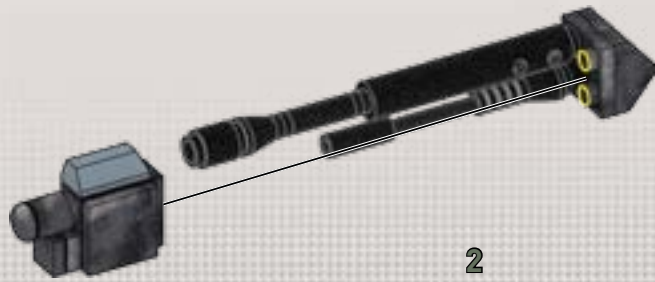
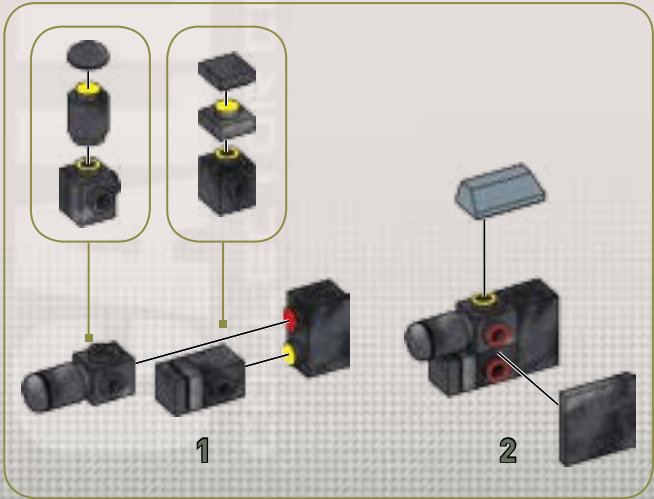
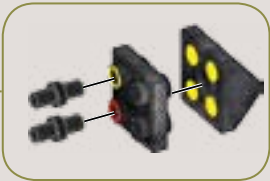
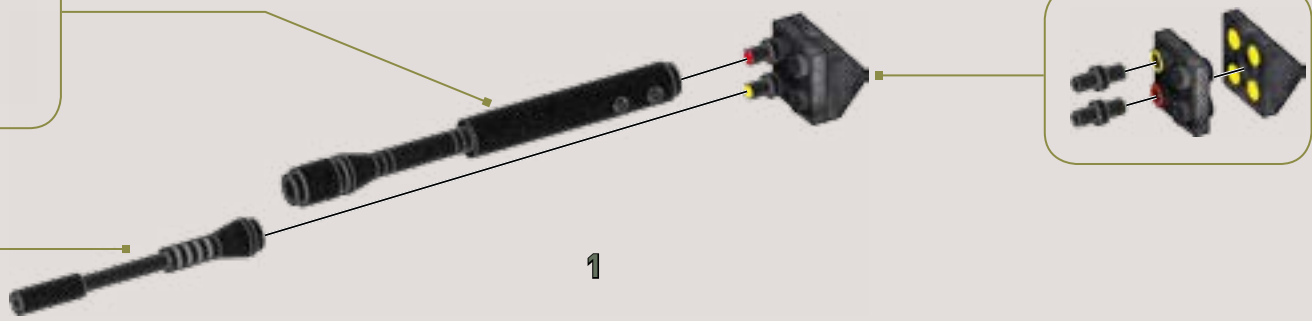

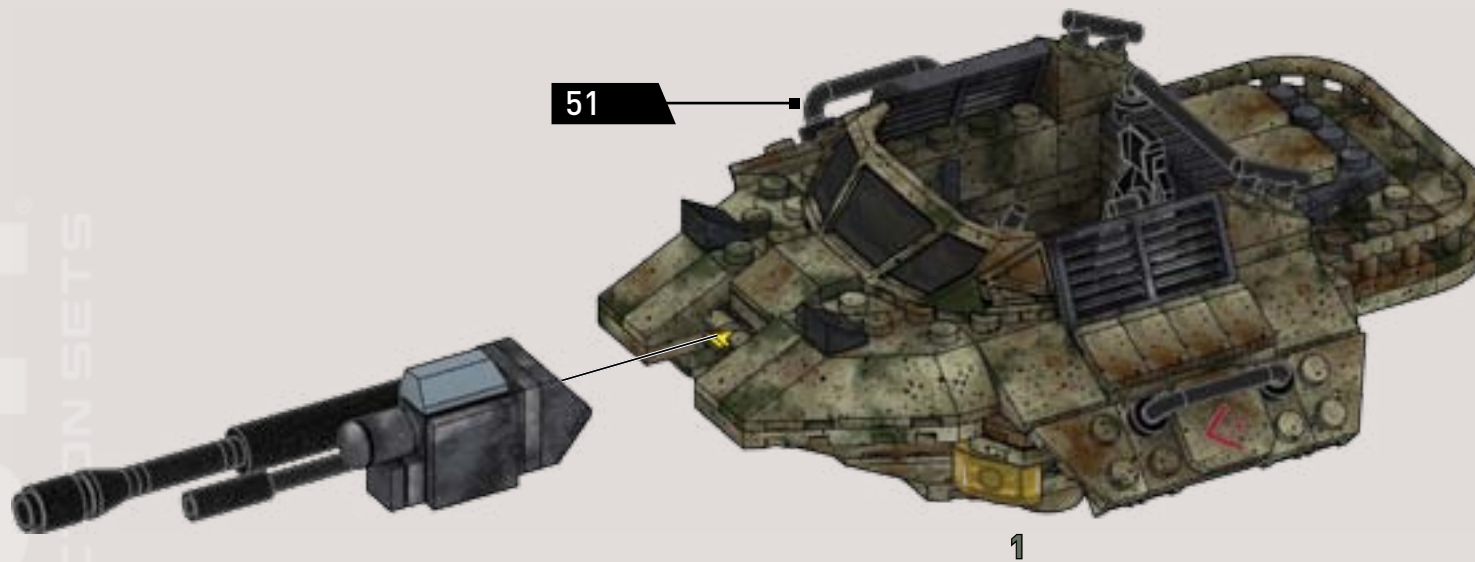



CALL OF DUTY®

COLLECTOR'S EDITION CONSTRUCTION SETS



55

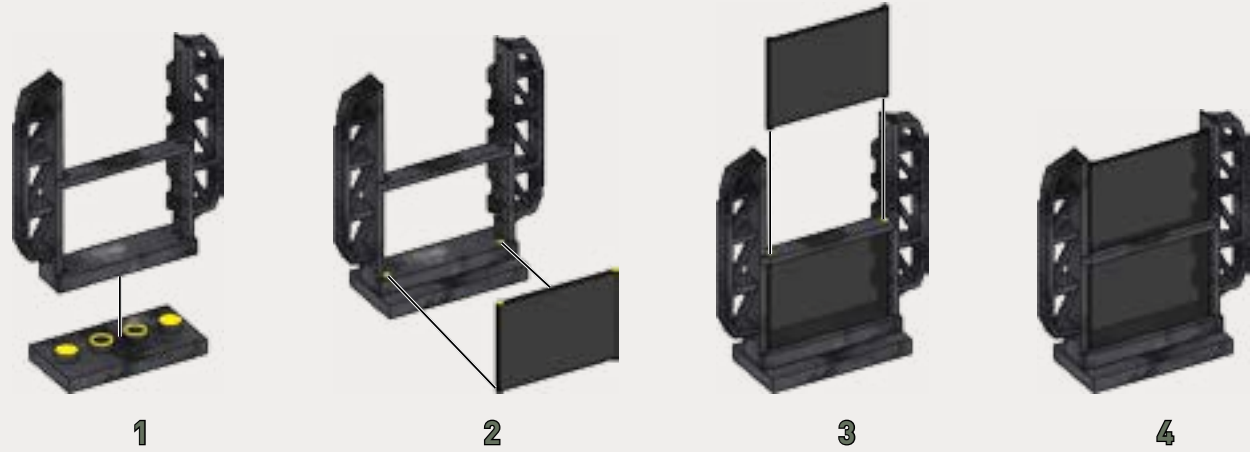
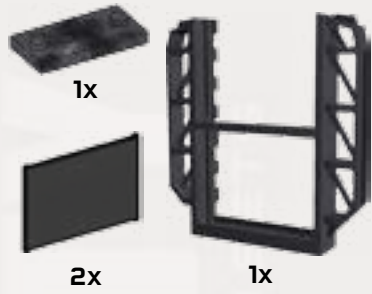

# CALL OF DUTY

## COLLECTOR CONSTRUCTION SETS

Complete your collection! / Complétez votre collection! / Complete su colección! / Vervollständige deine Sammlung!  
Vul je collectie aan! / Completa la tua collezione! / Completa a sua coleção! / Uzupełnij swoją kolekcję!

[callofduty.megabloks.com](http://callofduty.megabloks.com)



CNG75



CNG76

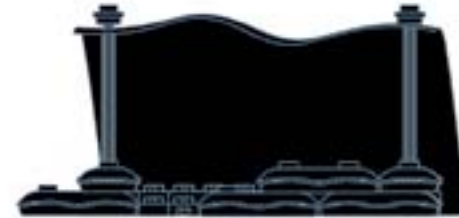

CNG78

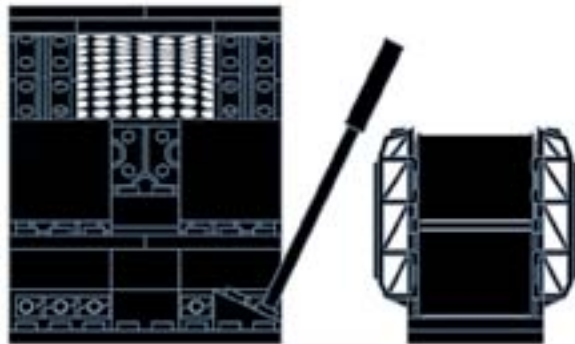

CNC68



CNG80



CNG74

Each sold separately and subject to availability. / Tous vendus séparément. Certains produits peuvent ne pas être commercialisés. / Se venden por separado y están sujetos a disponibilidad. / Vendidos em separado e sujeitos à disponibilidade. / Ognuno in vendita separatamente secondo disponibilità. / Alle Artikel separat erhältlich. Einige Artikel werden nicht in allen Ländern vertrieben. / Sprzedawane oddzielnie w zależności od dostępności. / Per stuk verkrijgbaar en niet overal leverbaar. / Каждый продукт продается отдельно, в зависимости от наличия. / Sælges separat og så længe lager haves. / Alla delar säljs separat så långt lagret räcker. / Hver leke selges separat så langt lageret rekker. / Jokainen myydään erikseen, saatavuus voi vaihdella. / Το καθένα πωλείται ξεχωριστά και ανάλογα με τη διαθεσιμότητα.

每件单独出售，并且视库存情况而定。 / それぞれ在庫状況に従って個別に販売されます。

تباع كل منها على حدة وتخضع لتوفرها.

