

# TWISTIN' TRUCK TRIALS™



## INSTRUCTIONS



55659-0920

Keep these instructions for future reference as they contain important information.

### CONTENTS / LABELS

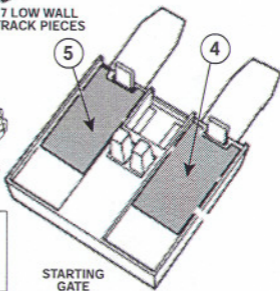
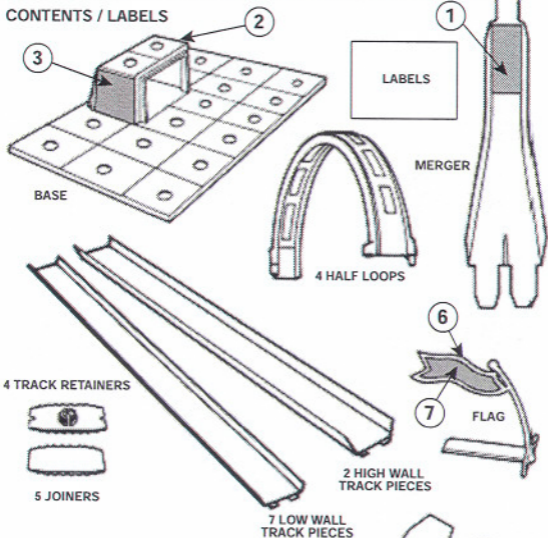

**WARNING:**  
CHOKING HAZARD - Small parts.  
Not for children under 3 years.

© 2002 Mattel, Inc., El Segundo, CA 90245 U.S.A. All Rights Reserved.  
Mattel U.K. Ltd., Vanwall Business Park, Maidenhead SL6 4UB. Helpline 01628500303.

Mattel Australia Pty Ltd., Richmond, Victoria, 3121. Consumer Advisory Service 1800 800 812 (valid only in Australia).

## ASSEMBLY

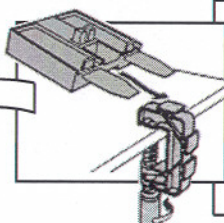

**Handy Tip:**  
To protect sensitive furniture surfaces, use a cloth or towel between the C-clamp and the surface to be clamped.

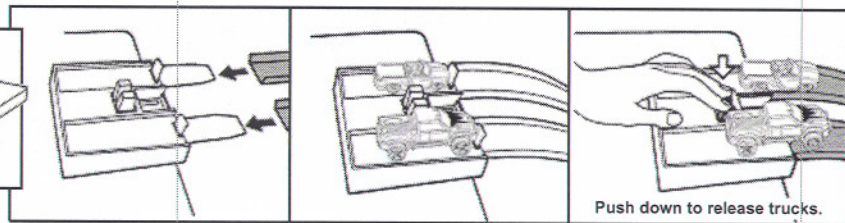

Push down to release trucks.

1	4	7	10	13	16
2	5	8	11	14	17
3	6	9	12	15	18

BASE HAS NUMBERED POSITIONS.

Assemble two loops.

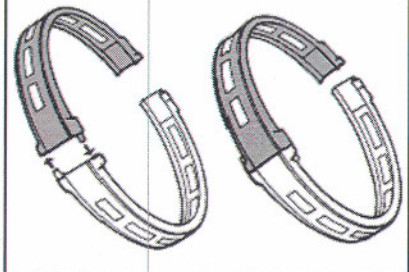

Attach retainers to loop ends and snap onto numbered positions on base. (7&13, 10&16)

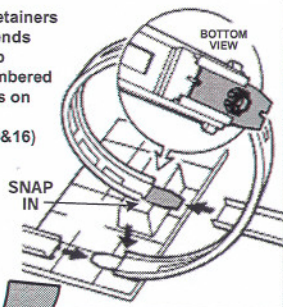

Attach track.

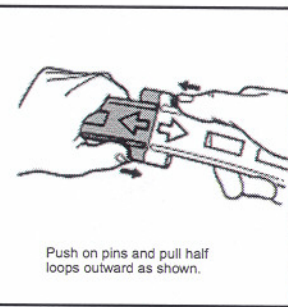
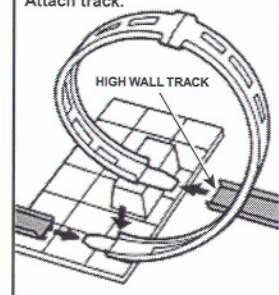

Push on pins and pull half loops outward as shown.

To regulate speed of cars, change height of the clamp. Steeper angles should produce faster speeds

**NOTE:** Do not let track touch floor or car will jump track.

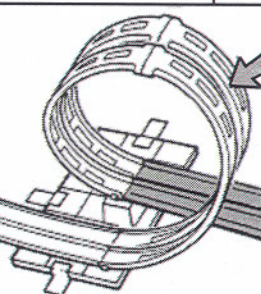
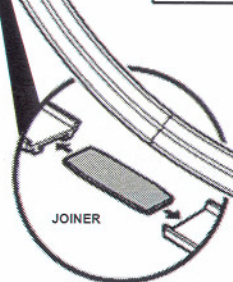

HIGH WALL TRACK

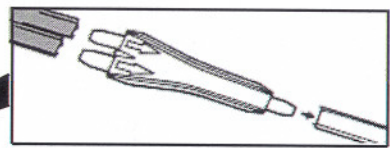

**IMPORTANT!** When playing on a smooth surface, tape down base. On carpeted surface, use books to hold base.

## CAR-CHALLENGING SUPER LOOP LAYOUTS

Match numbers listed below to numbers on base when assembling the loops. Attach track to loop ends.

1	4	7	10	13	16
2	5	8	11	14	17
3	6	9	12	15	18

For best results rotate the loop joiners in the base to help your cars complete the loops.

- ENTER (Car enters loop) ①
- CENTER (Center of loop) ⑩
- EXIT (Car exits loop) ⑯

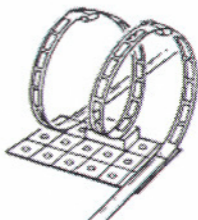
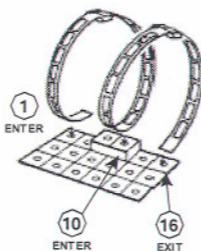

- ENTER ⑦
- CENTER ⑨
- EXIT ⑥

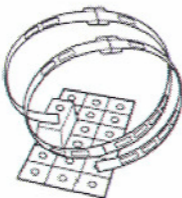

- ENTER ①
- CENTER ⑩
- EXIT ⑯

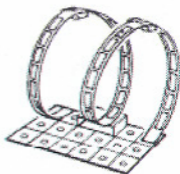

- ENTER ⑦
- CENTER ⑮
- EXIT ⑤



- ENTER ⑫
- CENTER ⑪
- EXIT ⑩

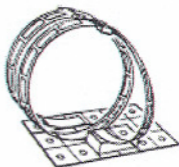

# EASY-RACING SINGLE LOOP LAYOUTS

COLUMN

ENTER (7)

EXIT (1)

ENTER (10)

EXIT (16)

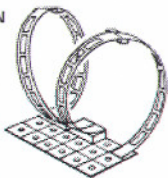

COLUMN

ENTER (7)

EXIT (1)

ENTER (10)

EXIT (16)

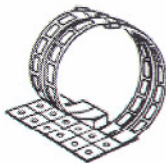

ENTER (7)

EXIT (3)

ENTER (10)

EXIT (2)

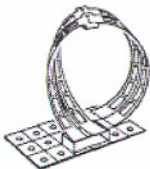

ENTER (7)

EXIT (18)

ENTER (10)

EXIT (17)

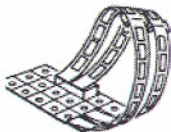

ENTER (7)

EXIT (1)

ENTER (10)

EXIT (8)

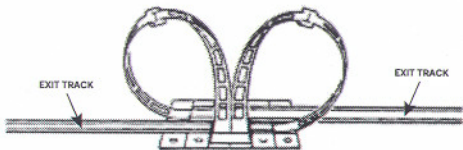

## CONSUMER INFORMATION

MATTY MATTEL™ by



YOU CAN TELL IT'S MATTEL!™ Call us toll-free or write with any comments or questions about our products or service, Monday-Friday, 8:00 a.m.-6:00 p.m. Eastern Time. Outside U.S.A., see telephone directory for Mattel listing. Consumer Relations, Mattel, Inc., 333 Continental Blvd., El Segundo, CA 90245 U.S.A.

1 (800) 524-TOYS



CONFORMS TO THE SAFETY  
REQUIREMENTS OF ASTM F963.

We are dedicated to quality products.