

# Barbie

Studio™

# Lipgloss Maker

## Instructions

### CONTENTS:



Please remove everything from the package and compare to the contents shown here. If any items are missing, please call 1-800-524-TOYS.

Keep these instructions for future reference as they contain important information.



67143-0920G1  
67143-0700404

**1**

## Assemble Flower Lock, Mixer, and Handle

Press on flower lock. Swing up to open doors.

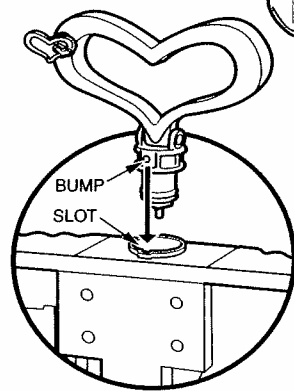
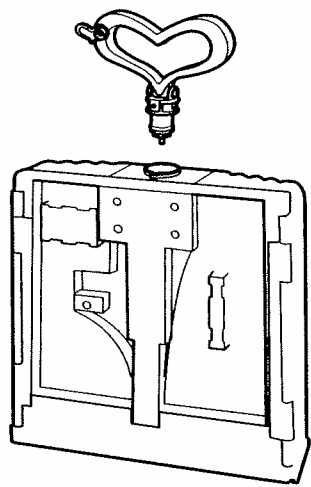

1. Line up purple bump with slot.

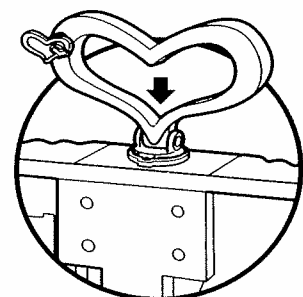
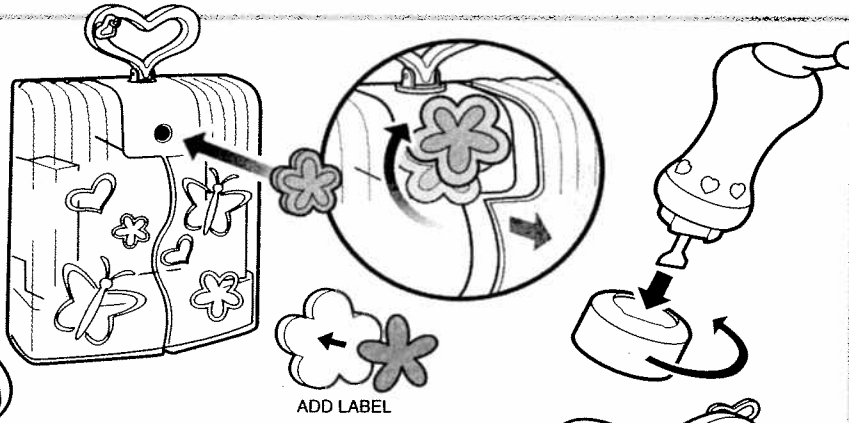

2. Press handle all the way down.

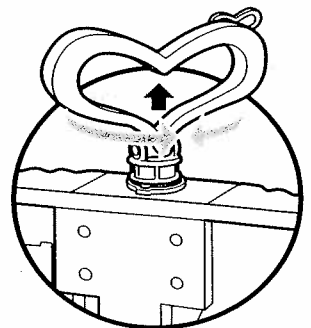

3. Pull up and handle turns freely.

**2**

## Fill Ejector With Base Material

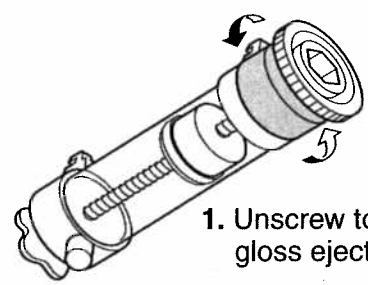

1. Unscrew top of glass ejector.

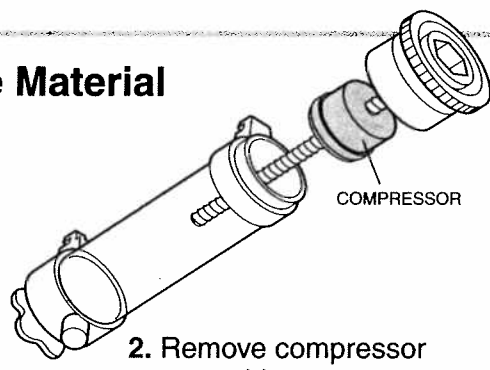

2. Remove compressor assembly.

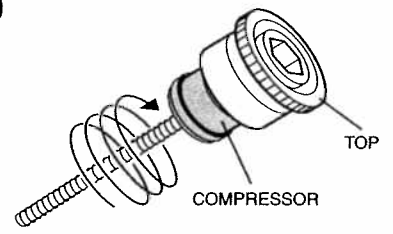

3. Hold top while spinning compressor clockwise as far as it will go.

**NOTE:** BEFORE USE, PLACE BAG IN WARM (NOT HOT) WATER TO SOFTEN, THEN DRY BAG.

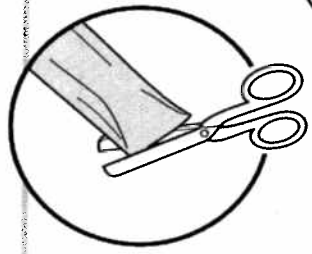

4. Cut bag with safety scissors (not included). Insert open end of bag into glass ejector.

All the way down!

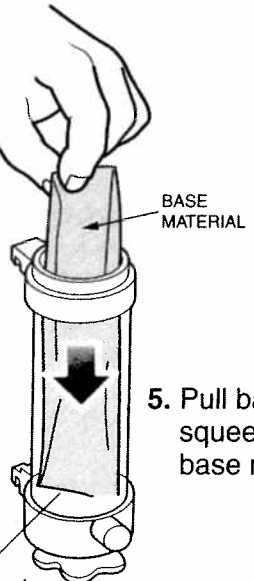

5. Pull bag up, squeezing base material.

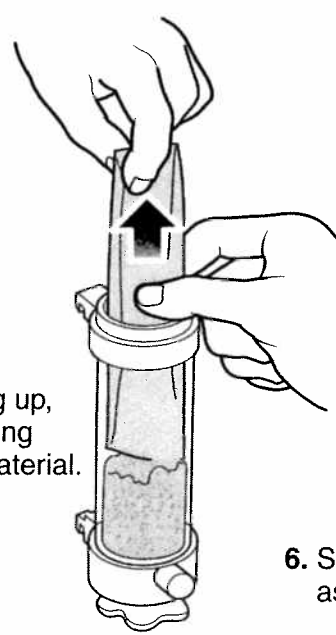

6. Screw compressor assembly back on.

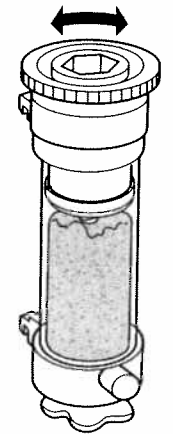
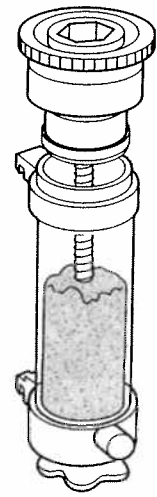

7. Screw down until you feel pressure, then turn back 1/4 turn.

### 3 Getting Ready

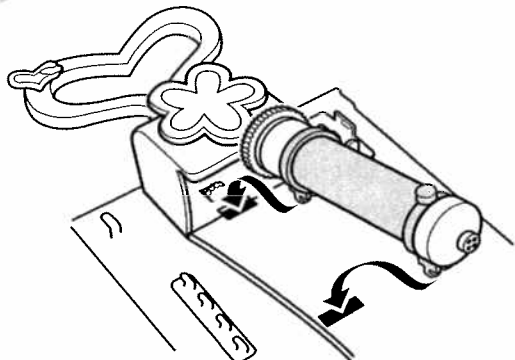

Insert ejector into back wall and pull down. Lift up and out to remove.



Apply labels to pots.

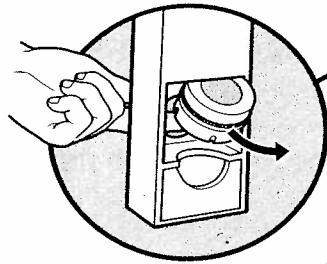

Push through hole in back to eject pot.

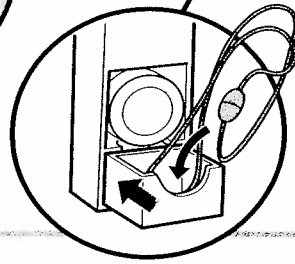
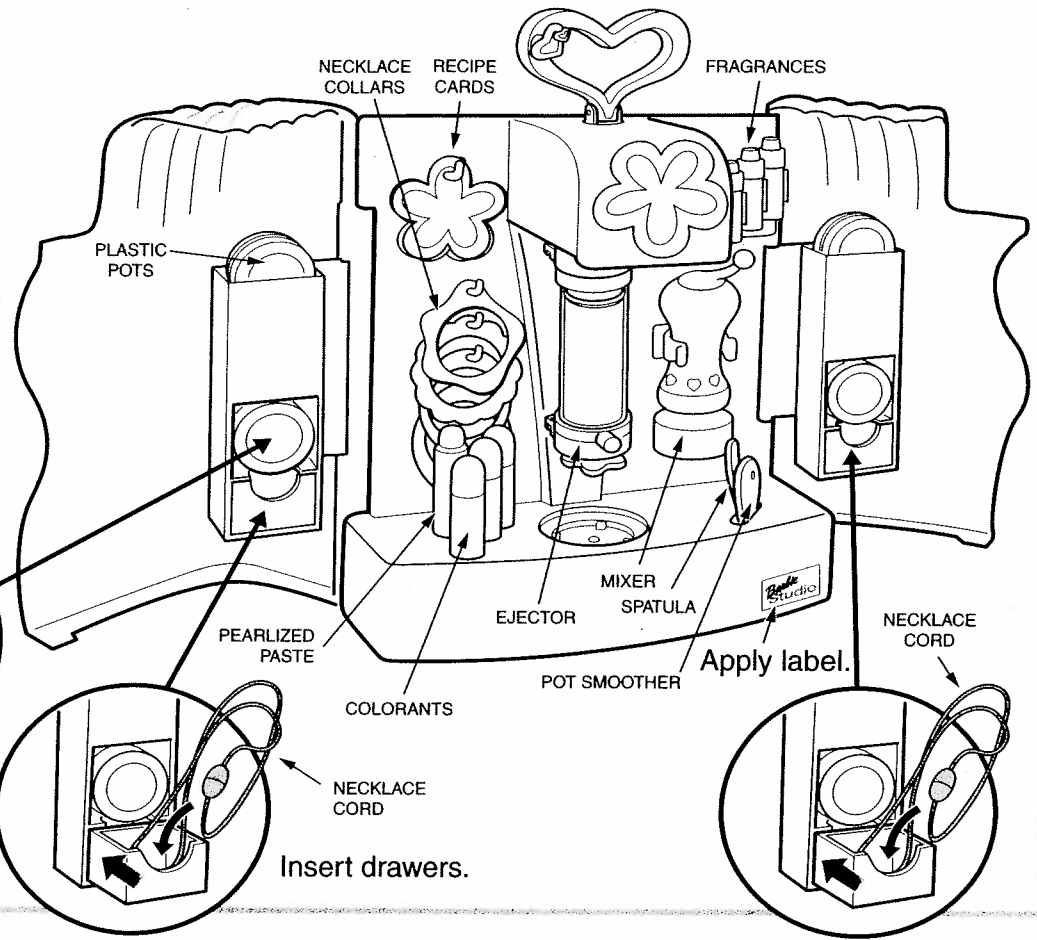

Insert drawers.

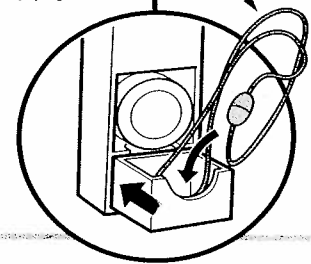

NECKLACE CORD

### Fill Pots

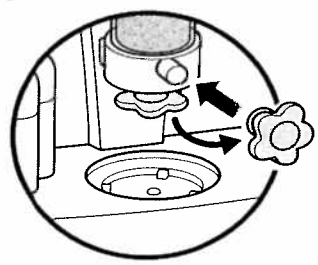

1. Pull cap from bottom of ejector and place on front.

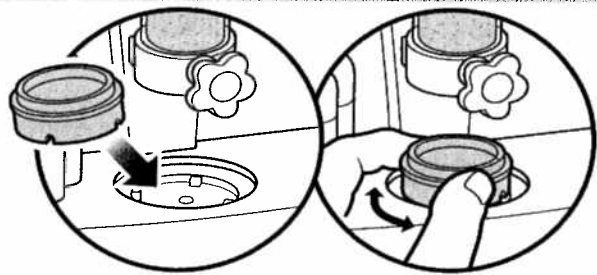

2. Turn pot to lock into position on tabs.

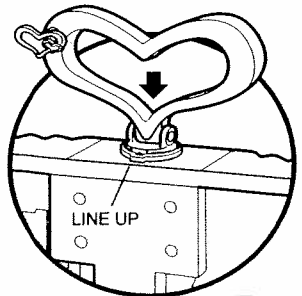

3. Line up purple bump with slot.

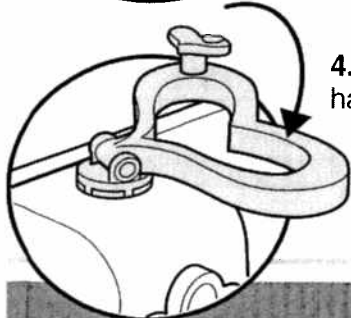

4. Press handle down.

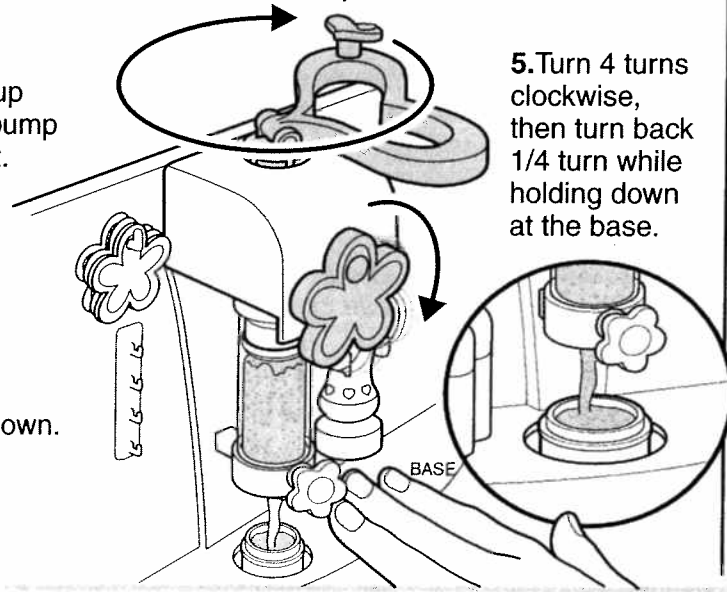

5. Turn 4 turns clockwise, then turn back 1/4 turn while holding down at the base.

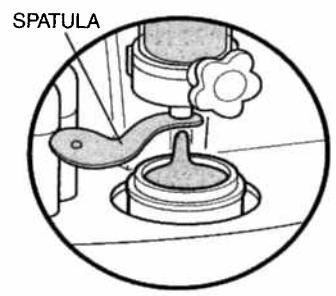

6. Scrape lip gloss material from ejector spout with spatula and press into pot.

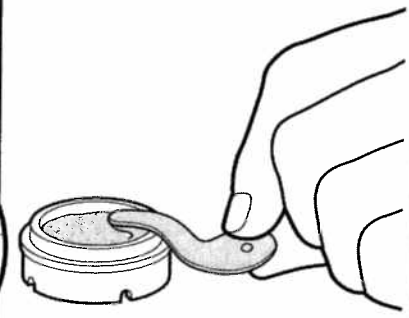

7. Scrape excess lip gloss material into pot.

# 5

## Add Color and Fragrance to Lip Gloss

Use recipes provided or make up your own!

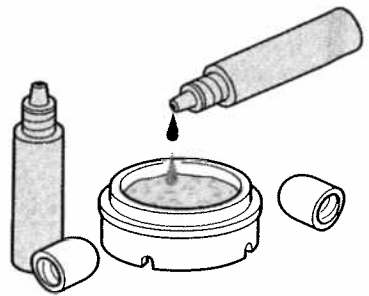
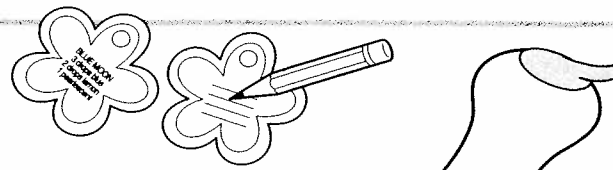

1. Add drops of color.



2. Add fragrance.

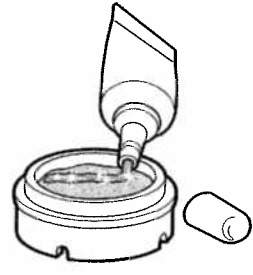

3. Add pearalized paste.

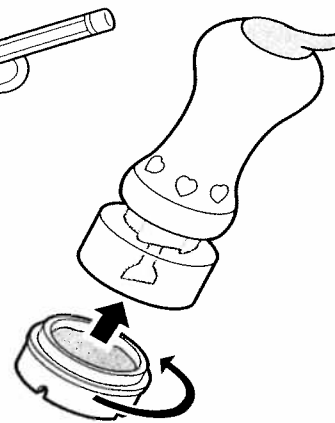

4. Screw gloss pot onto mixer.

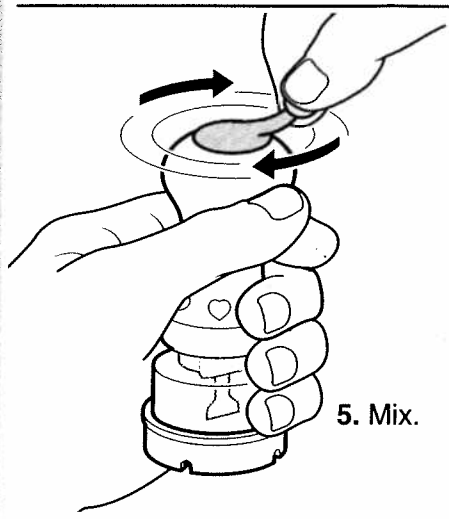

5. Mix.

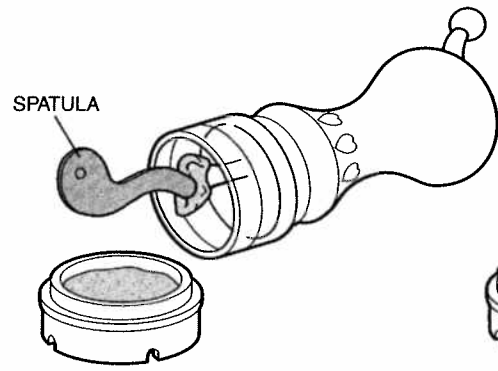

6. Unscrew gloss pot. Clean up lip gloss material with spatula. *Cleaning instructions on back page.*

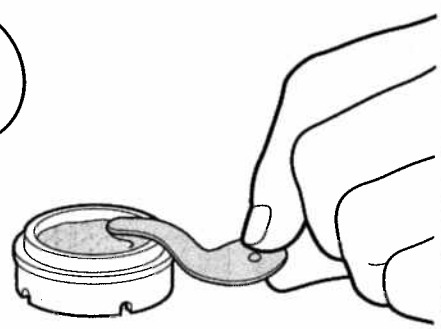

7. Scrape excess base material into pot.

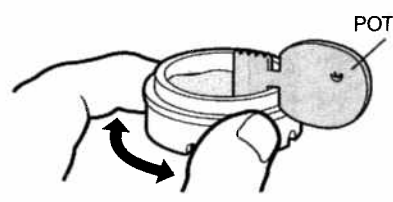

8. Smooth lip gloss material with pot smoother by rotating pot.

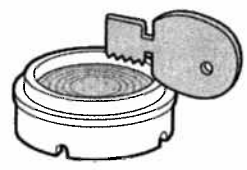

9. Use serrated edge for grooves.

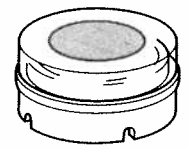

10. Screw lid onto pot.

# 6

## Make A Necklace

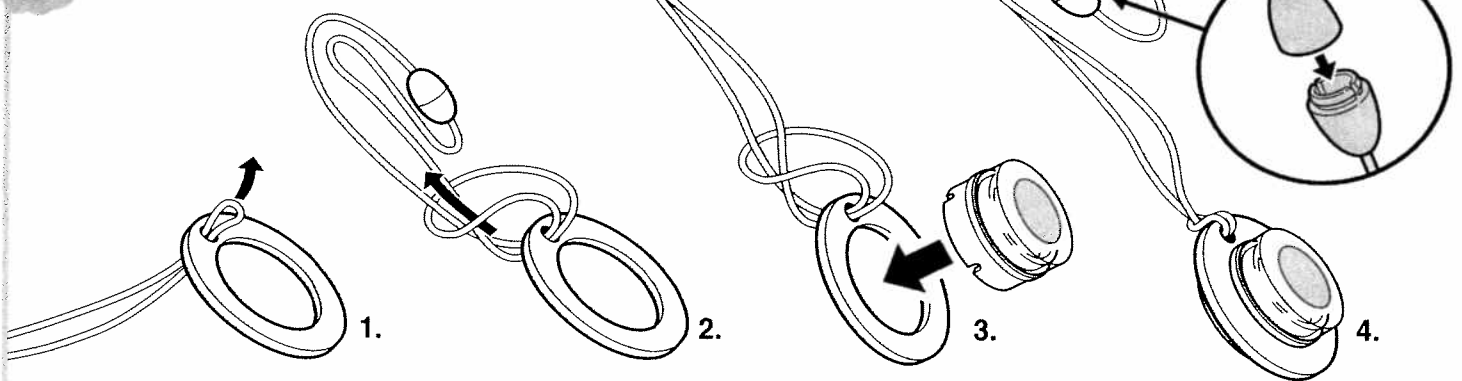

1.

2.

3.

4.



## CLEANING

Disassemble gloss ejector and mixer. Wash parts with warm (not hot) soapy water. Rinse, then dry thoroughly before reassembling.

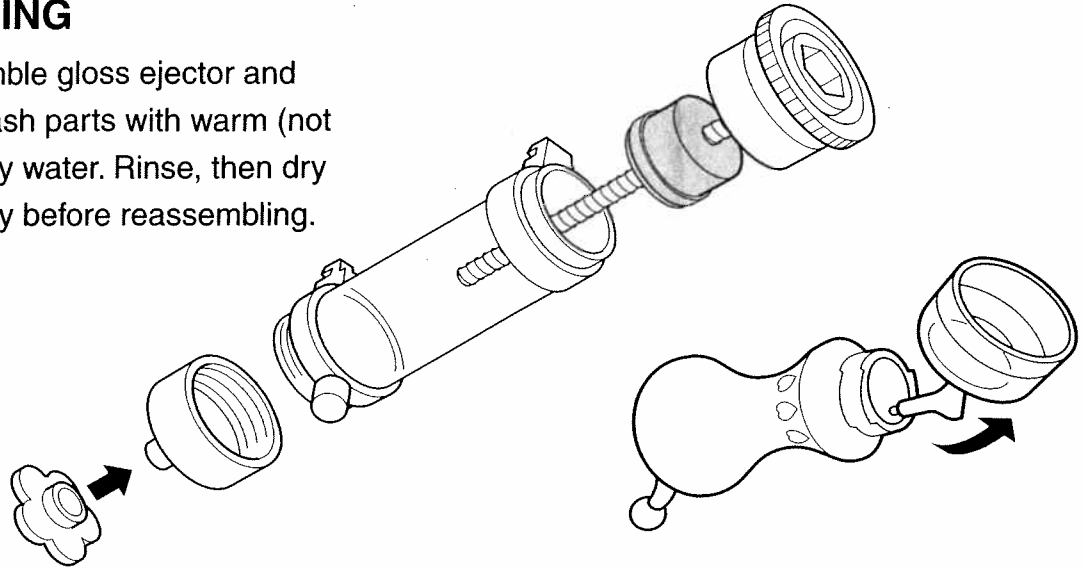

## STORAGE

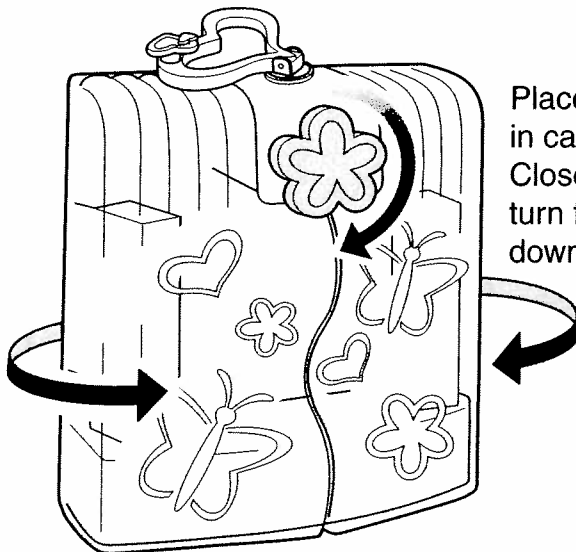
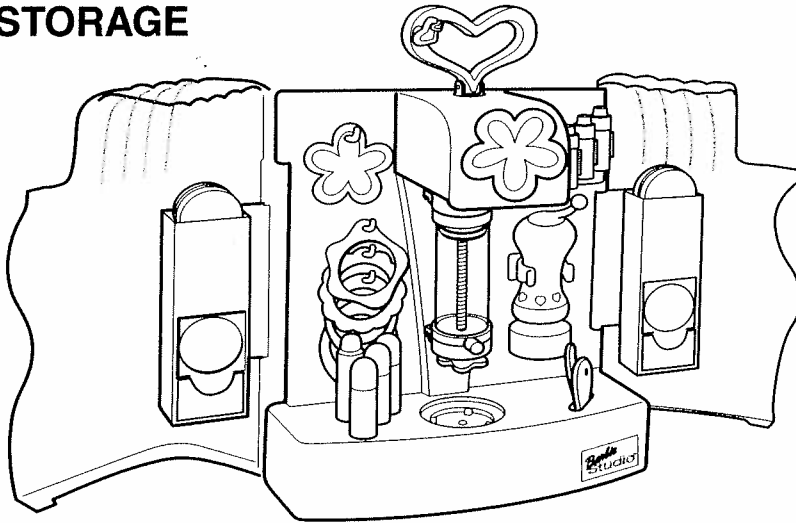

Place parts in carrying case. Close doors and turn flower lock down to lock doors.



Line up purple bump with slot, then lift handle "UP" for carrying.

**IMPORTANT:** As with all quality cosmetics/ingredients, colors may stain certain fabrics; keep cosmetics away from fabrics and carpets.

**NOTES:**

- Use only ingredients that come with kit. Do not use other colorants, fragrances or base material.
- Do not exceed more than 8 drops of colorants and fragrances (combined).
- Use warm water (not hot) to soften the base material when it becomes hard inside the gloss ejector.
- Before re-using the parts, clean and dry each part thoroughly.
- Clean and dry spatula, pot smoother and paddle mixer completely before mixing new colors.
- Use mild soap and water to remove lip gloss from skin.
- If the gloss ejector has not been used for a while, remove cap from the front and reattach it on the bottom of the ejector.
- **Remix pearlized paste before using**
  - 1) Place tube in warm (NOT HOT) water for a few minutes to soften the paste.
  - 2) Shake tube vigorously.

**BASE MATERIAL:** Net Wt. 30 g. e (1.058 oz.).

**PEARLIZED PASTE:** Net Wt. 3.747 ml. e (0.1267 fl. oz.).

**FRAGRANCES:** 3 bottles total, Net Wt. 1.574 ml. e (0.0532 fl. oz.) each.

**COLORANTS:** 3 bottles total, Net Wt. 3.8 ml. e (0.1285 fl. oz.) each.

**INGREDIENTS**

**Base Material:** Ricinus Communis (Castor Oil), Cera Alba (Beeswax), Isopropyl Palmitate, PEG-22/Dodecyl Glycol Copolymer, Cetyl Alcohol, Monoammonium Glycrrhizate, Tocopheryl Acetate, Propylparaben.

**Pearlized Paste:** Ricinus Communis (Castor Oil), Mica (and) Titanium Dioxide, Cera Alba (Beeswax), Isopropyl Palmitate, PEG-22/Dodecyl Glycol Copolymer, Cetyl Alcohol, Tocopheryl Acetate, Propylparaben.

**Colorants:** Blue: Ricinus Communis (Castor Oil), C.I. 42090 (FD & C Blue No. 1 Alum. Lake), Tocopheryl Acetate.

Red: Ricinus Communis (Castor Oil), C.I. 45410:1 (D & C Red No. 27 Alum. Lake), Tocopheryl Acetate.

Yellow: Ricinus Communis (Castor Oil), C.I. 19140 (FD & C Yellow No. 5 Alum. Lake), Tocopheryl Acetate.

**Bubble Gum, Cherry, Strawberry Fragrances:** Ricinus Communis (Castor Oil), Perfume/Fragrance, Tocopheryl Acetate, Propylparaben .

**TWO YEAR LIMITED WARRANTY**

Mattel, Inc. warrants to the original consumer purchaser that this product will be free of defects in material or workmanship for two years (unless specified in alternate warranties) from the date of purchase. If defective, return the product along with proof of the date of purchase, postage prepaid, to Consumer Adjustment Center, 15930 E. Valley Boulevard, City of Industry, California 91744 for replacement or refund at our option. This warranty does not cover damage resulting from unauthorized modification, accident, misuse, or abuse. **Valid only in U.S.A.** This warranty gives you specific legal rights and you may also have other rights which vary from state to state.

Send only the product to the address above. Send all correspondence to Consumer Affairs, Mattel, Inc., 333 Continental Blvd., El Segundo, California 90245-5012, U.S.A. Or you may phone us toll-free at 1-800-524-TOYS, Monday – Friday, 8:00 a.m. – 5:00 p.m. PST; 11:00 a.m. – 8:00 p.m. EST.

**CONSUMER INFORMATION**

MATTY MATTEL™ TOYS



YOU CAN TELL IT'S MATTEL! CALL us toll-free or write with any comments or questions about our products or service. Monday-Friday, 8:00 a.m.-5:00 p.m. PST; 11:00 a.m.-8:00 p.m. EST. Outside U.S.A., see telephone directory for Mattel listing. Consumer Affairs, Mattel, Inc., 333 Continental Blvd., El Segundo, CA 90245 USA

**1 (800) 524-TOYS**



CONFORMS TO THE SAFETY REQUIREMENTS OF ASTM F963.

**We are dedicated to quality products.**