

**JEEP<sup>®</sup>  
SAFARI<sup>®</sup>**

**POWER  
WHEELS<sup>®</sup>**

# ASSEMBLY MANUAL

**MODEL 86250**

76229

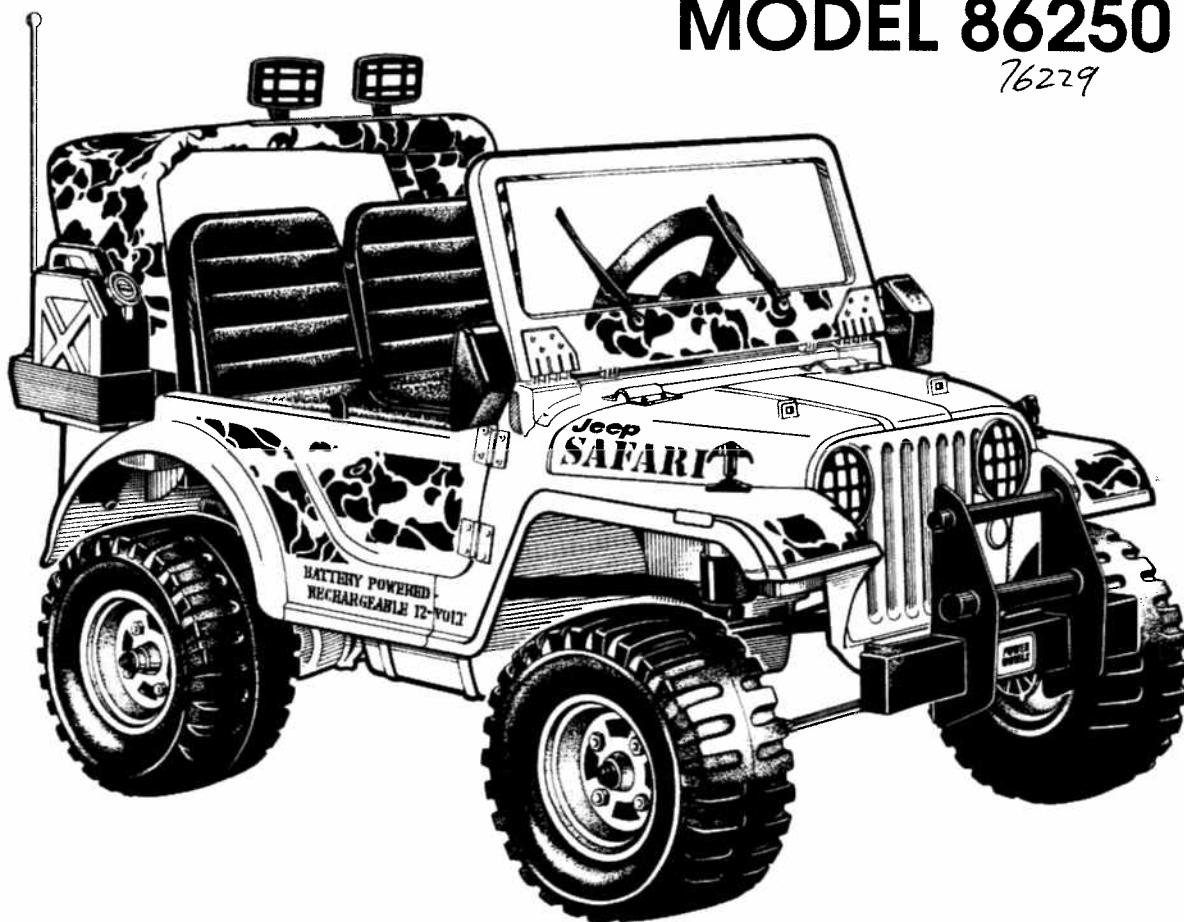

ALL-SURFACE VEHICLE • USE TYPE H BATTERIES ONLY



**JEEP<sup>®</sup>**  
**SAFARI<sup>®</sup>**  
**MODEL 86250**

Power Wheels  
Fort Wayne, Indiana  
A Kransco Group Company

THE TRADEMARK JEEP IS LICENSED FROM JEEP EAGLE CORPORATION  
©1989 KRANSCO, SAN FRANCISCO, CA - ALL RIGHTS RESERVED  
U.S. PATENTS 4,555,451; 4,558,263; 4,709,958; AND U.S. PATENTS PENDING

**CAUTION:** Electric vehicle not recommended for children under 3 years of age. As with all electrical products, precautions should be observed during handling and use to prevent electrical shock.



**CHARGER:** Type H Input: 120 VAC 60 Hz 30W  
Output: 11.3 VDC 1200 mA

# POWER WHEELS HAS THE MOST COMPREHENSIVE SERVICE PROGRAM IN THE TOY INDUSTRY

## TOLL-FREE SERVICE LINES

- Multi (twenty-five) service lines, open from 8:00 AM to 5:00 PM EST, Monday through Friday

**1-800-348-0751**

In Indiana

**1-219-483-7299**

## A NATIONAL SERVICE CENTER NETWORK

- Over 230 service centers nationwide
- Our service centers will repair or replace parts under warranty at no charge
- For vehicles beyond warranty, our service centers will perform repairs for a minimal charge

# LARGE PARTS BAG

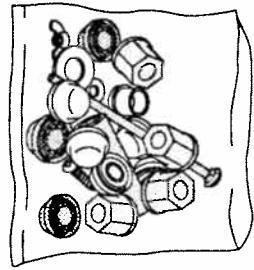

SMALL PARTS BAG

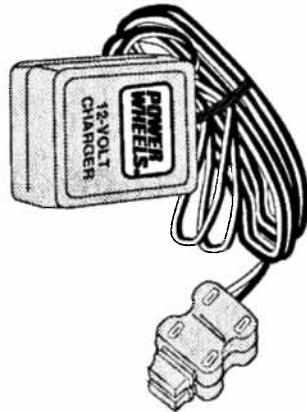

12-VOLT CHARGER

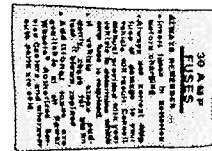

30 AMP FUSE KIT

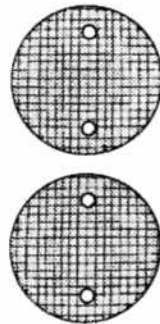

HEADLIGHT LENS (2)

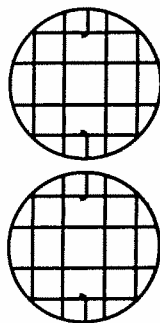

HEADLIGHT GUARDS (2)

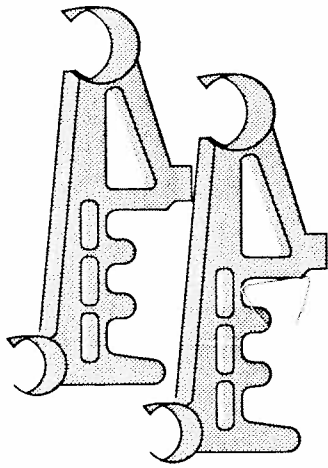

K-C LIGHT RACK (2)



MICROPHONE

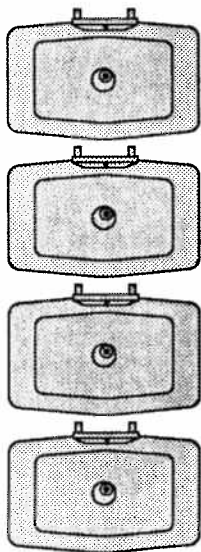

K-C LIGHT / MIRROR BACK (4)

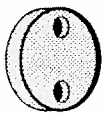

STEERING WHEEL CAP



MIRROR BRACKET (2)

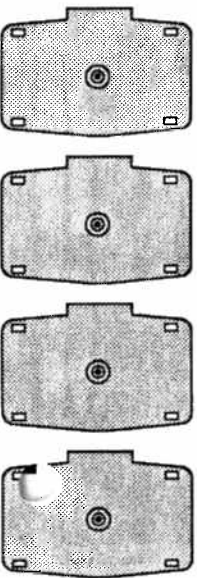

K-C LIGHT / MIRROR FRONT (4)

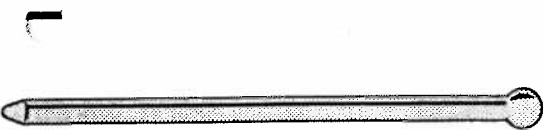

ANTENNA

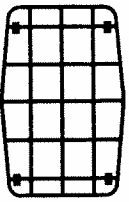

K-C LIGHT GUARDS (2)

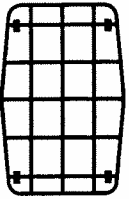

## SMALL PARTS BAG

CAUTION: NEVER LEAVE THESE PARTS IN THE PRESENCE OF SMALL CHILDREN

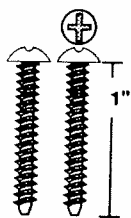

1" SCREW (2)  
FOR STEERING WHEEL  
CAP

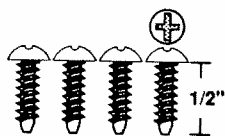

1/2" SCREW (4)  
FOR MIRRORS AND  
K-C LIGHTS

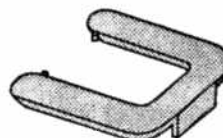

U-CLIP  
FOR BATTERIES



3/16" KEEPER (4)  
FOR MIRROR/HINGE

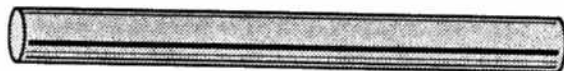

SPARE TIRE ROD



MIRROR HINGE PIN (2)  
FOR MIRRORS AND HINGES



SMALL .354 RETAINER (3)  
FOR STEERING COLUMN AND SPARE TIRE

# ADDITIONAL ITEMS IN BOX

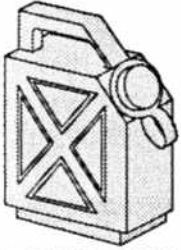

WATER CAN

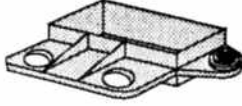

WATER CAN BRACKET

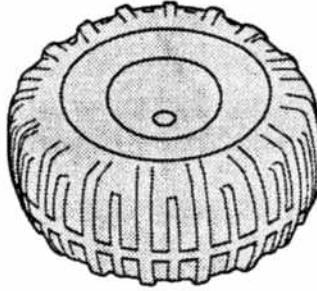

SPARE TIRE



STEERING COLUMN

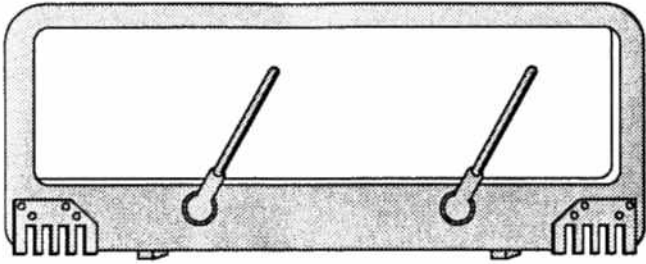

WINDSHIELD



STEERING WHEEL

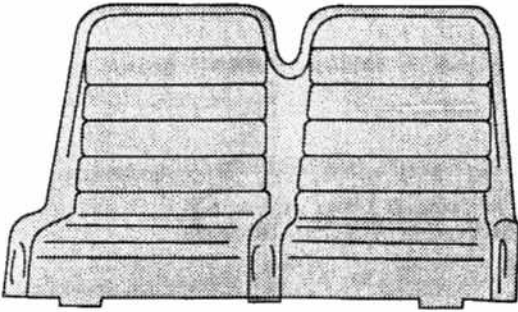

SEAT



ROLL-BAR (REAR)



ROLL-BAR (FRONT)

**NOT SHOWN:**  
ASSEMBLY MANUAL  
USE & CARE MANUAL  
WARRANTY CARD  
DECAL SHEET



NYLON SHROUD

# IMPORTANT BATTERY INFORMATION

THIS VEHICLE USES TYPE H BATTERIES AND TYPE H CHARGER ONLY. NO OTHER TYPE WILL WORK.

Even with proper care, rechargeable batteries will not last forever.

The replacement batteries **must be Type H batteries.**

To purchase, contact:

- Dealer where your vehicle was purchased.
- Authorized service center (See authorized service center list).
- Power Wheels Customer Service 1-800-348-0751 (Indiana 1-219-483-7299).

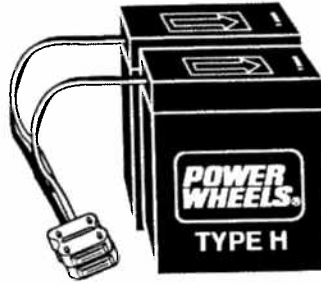

ALWAYS REPLACE BOTH BATTERIES.

## TOOLS NEEDED NOT INCLUDED



PHILLIPS  
SCREWDRIVER

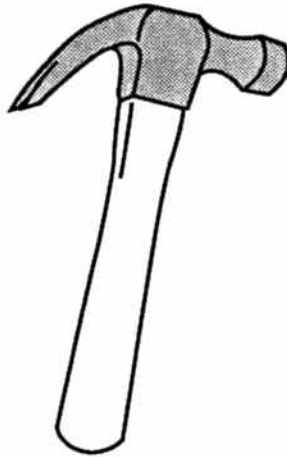

HAMMER

# A

## BATTERY CHARGING

### FOLLOW EACH STEP CAREFULLY

IF VEHICLE WAS PURCHASED WITHOUT BATTERIES:  
It is important that you use only Type H batteries.  
For more information on where to purchase these  
6-volt Type H batteries please refer to your Use and  
Care Manual.  
These batteries have the correct plug connectors  
and dimensions necessary for proper battery com-  
partment fit.

ASSEMBLY  
BY  
**ADULTS  
ONLY!**  
DO NOT OMIT  
ANY STEPS

**1**

OPEN hood.  
REMOVE 1" screws from  
pretend motor (3 places).  
REMOVE pretend motor.

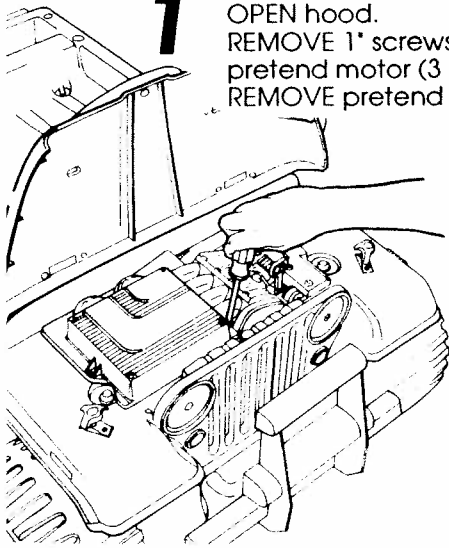

**2**

REMOVE batteries from  
battery compartment.

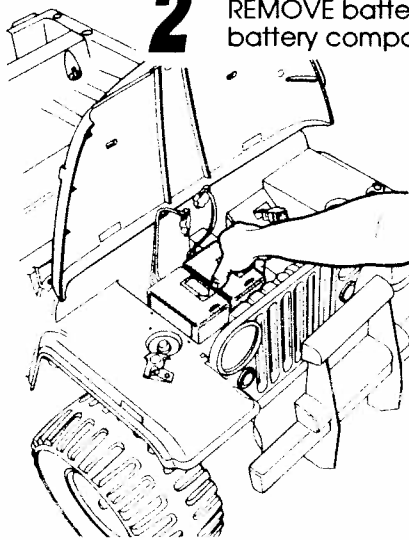

**3**

REMOVE fuses from envelope  
INSERT fuses into batteries.

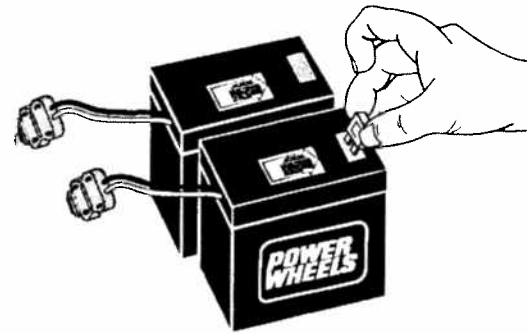

**4**

STACK one red battery connector  
on top of the other and snap  
together.

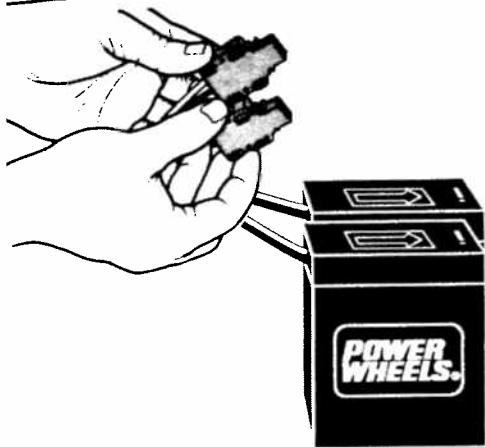

**5**

PLUG stacked red battery connectors  
into red charger connector.

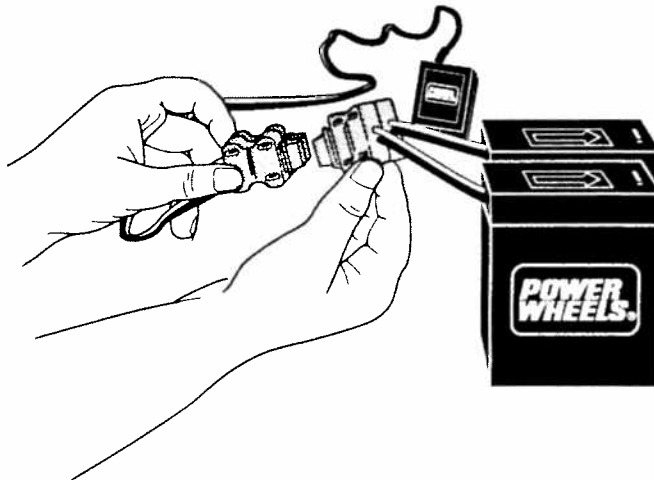



**6**

PLUG battery charger into wall outlet.  
 CHARGE battery for a minimum of 18  
 hours for the first charge. (After  
 that 14 hours  
 is enough.)  
 NEVER charge  
 over 30 hours.

FIRST TIME

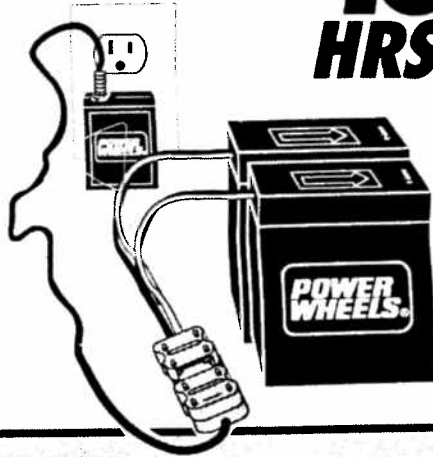
**18  
HRS.****B****STEERING COLUMN / STEERING WHEEL****1****TURN VEHICLE UPSIDE DOWN.**

SLIDE steering column through  
 holes in under side of body,  
 and through hole in top  
 of body.

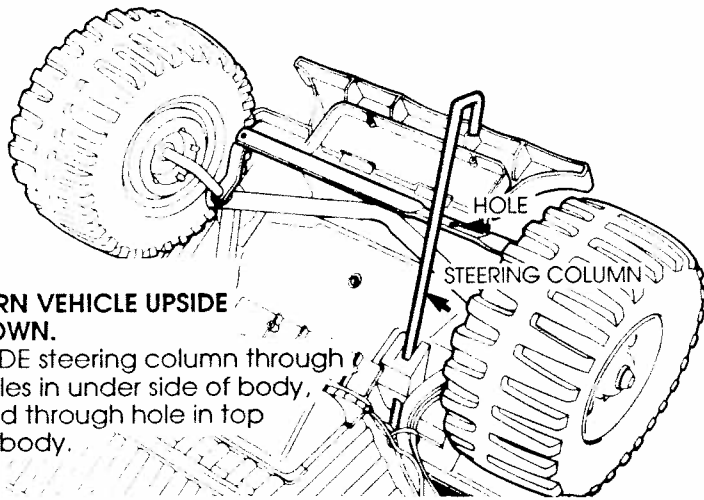
**2**

INSERT curved end of  
 steering column through  
 hole in steering linkage.

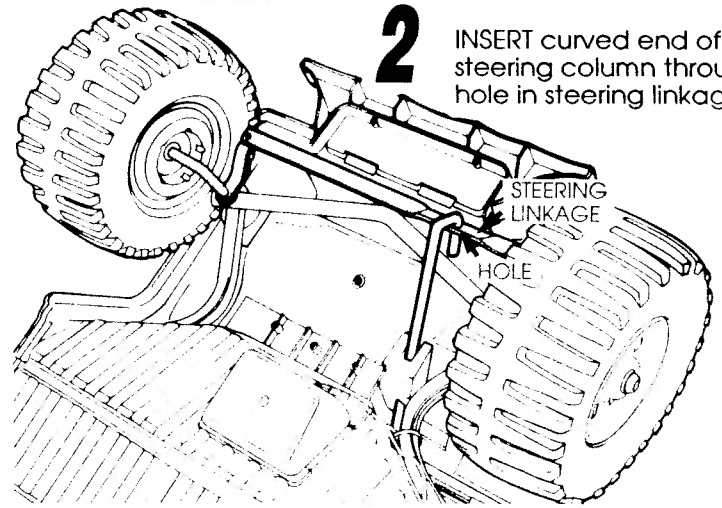
**3****TURN VEHICLE UPRIGHT.**

PUT steering wheel on  
 steering column.  
 SUPPORT the steering column  
 and hammer retainer  
 onto top end of steering column.

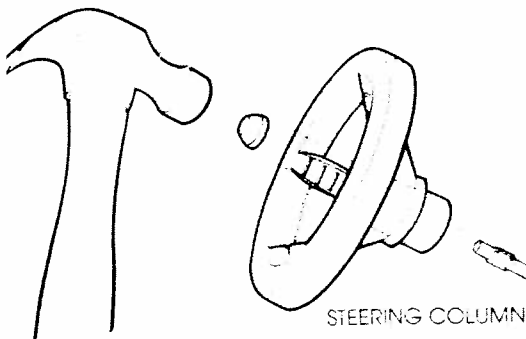
**4**

PLACE steering wheel  
 cap onto steering wheel.  
 INSERT two 1" screws  
 into holes.  
 TIGHTEN.

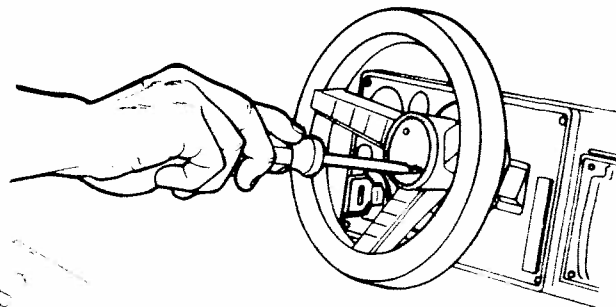

# C MIRRORS/WINDSHIELD

**1** SLIDE mirror bracket onto mirror back as shown.

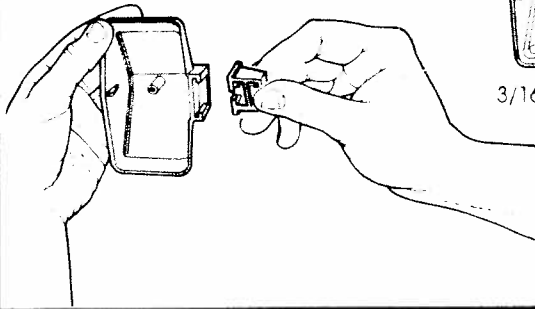

**2** SLIDE 3/16" keeper into slot in mirror bracket.  
(Indentation of keeper faces away from mirror)

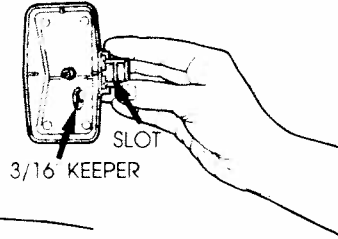

**4** INSERT mirror hinge pin into mirror bracket.  
PUSH hinge pin through keeper, so that all prongs on keeper are around the hinge pin.

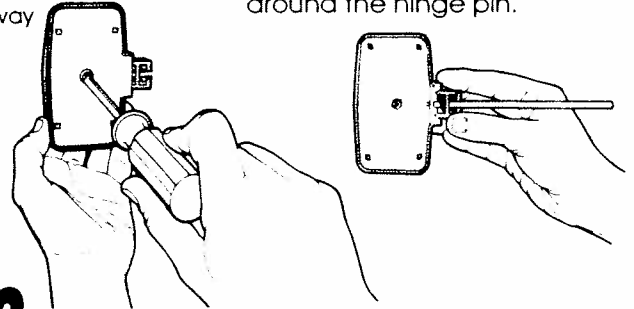

**3** PLACE mirror front onto mirror back.  
INSERT 1/2" screw into hole.  
TIGHTEN.

**5** SLIDE 3/16" keeper into slot in corner of windshield.  
(Indentation of keeper faces mirror.)  
PLACE windshield flat on hood with windshield knobs facing up.  
ALIGN holes in windshield with holes in hinge.  
PUSH hinge pin through holes in windshield, keeper, and hinge.  
(Note: use the mirror as a handle for pushing hinge through holes.)  
REPEAT for other side.

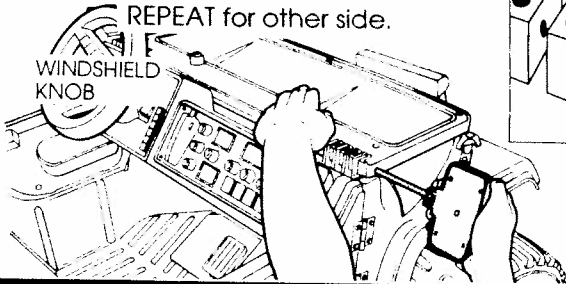
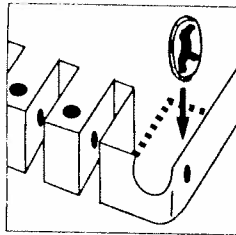

# D ROLL-BARS/ACCESSORIES

**1** PLACE nylon shroud on floor with flat edge towards the front (right side).  
POSITION front and rear roll-bars so they bend towards the rear (see illustration).  
SLIDE shroud onto roll-bars.

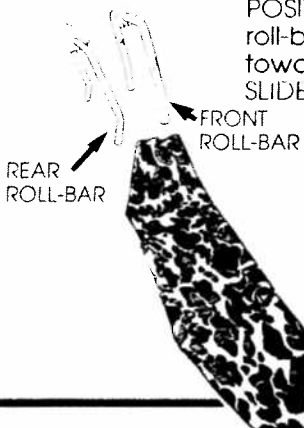

**2** SLIDE shroud onto both roll-bars working front and rear together.

**3** ALIGN holes in water can bracket with holes on right side of body.  
PLACE roll-bars into holes in body.

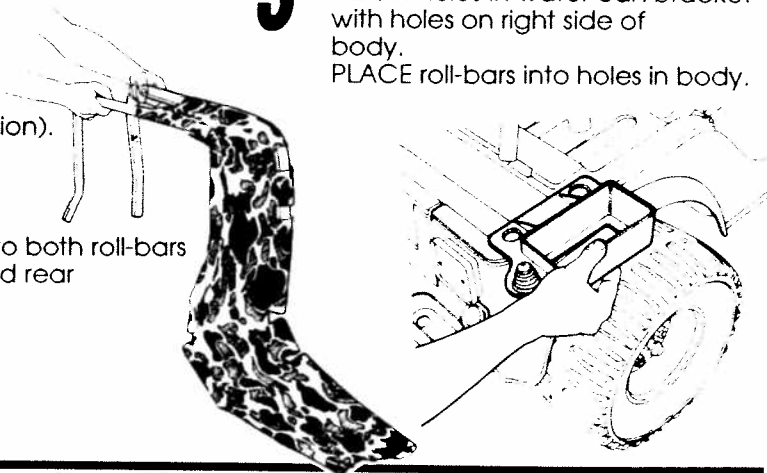

- 4** PLACE water can into position in bracket.  
 INSERT antenna firmly into hole in bracket.  
 Note: Wash water can before first use. (See Use & Care Manual).

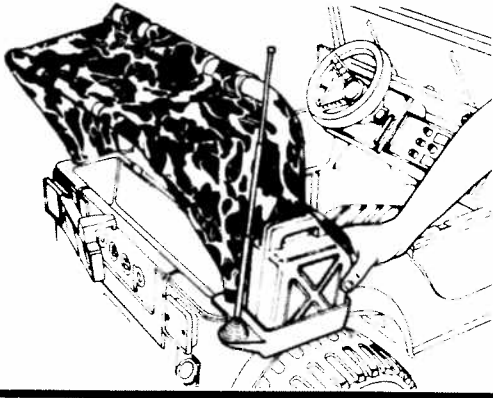

## DECALS

WIPE vehicle with a soft cloth to remove any dust.  
 APPLY numbered decals as shown.

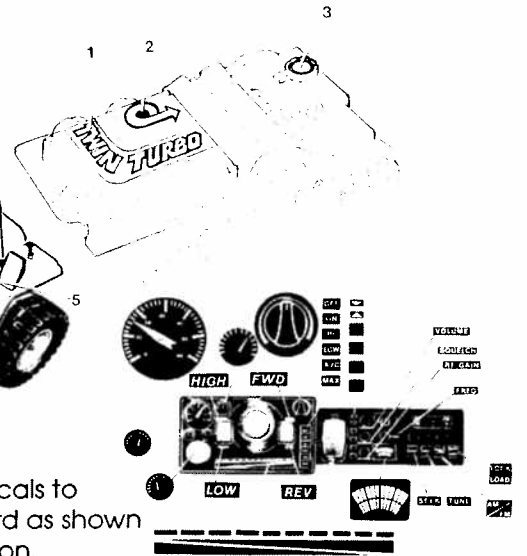
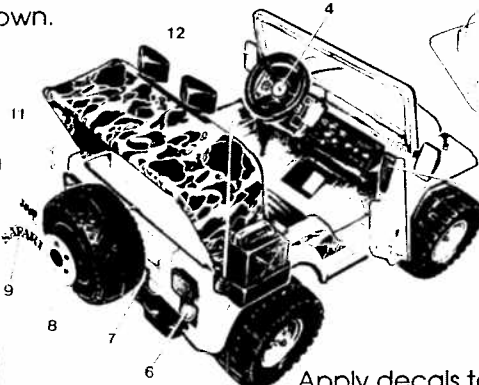
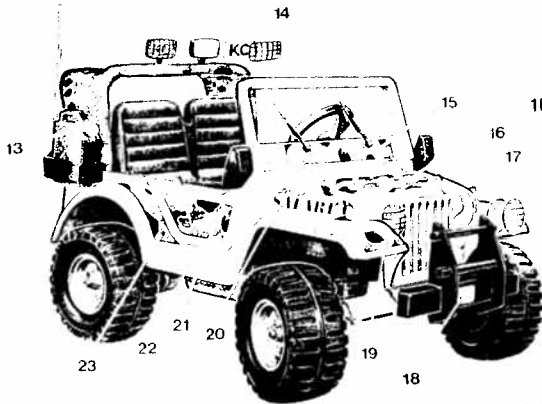

Apply decals to dashboard as shown in illustration.

## K-C LIGHT'S

- 2** PLACE K-C light front onto K-C light back.

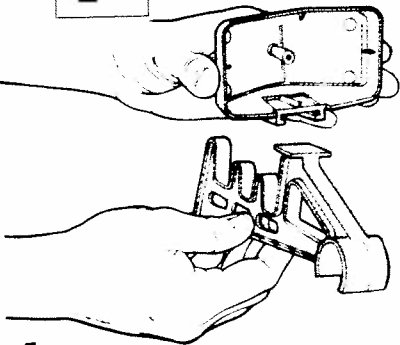

- 1** SLIDE K-C light back onto K-C light rack.

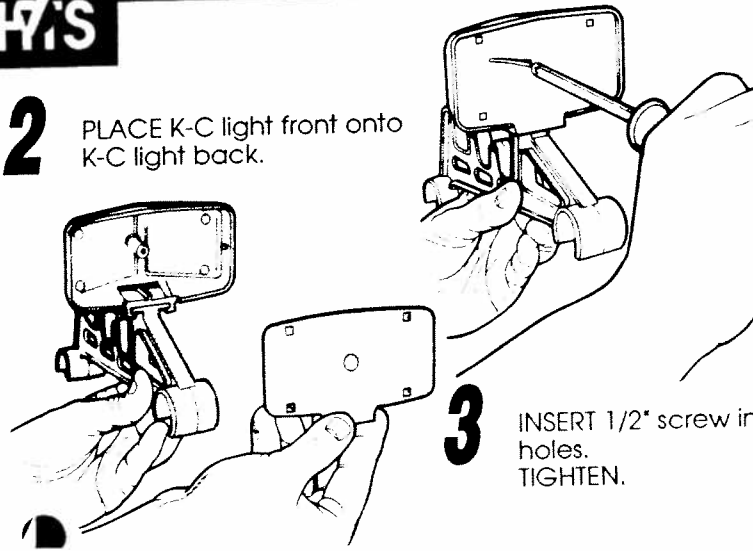

- 3** INSERT 1/2" screw into holes. TIGHTEN.

**4** Note: Apply decal #14 to K-C light before this step.  
SNAP K-C guard onto K-C light.

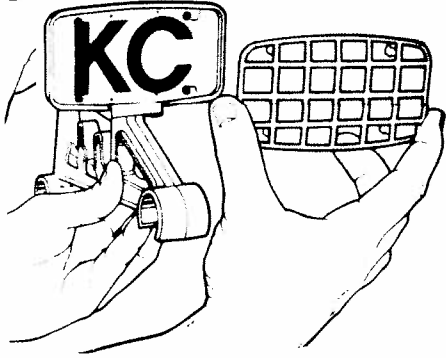

## F K-C LIGHTS CONT.

**5** SNAP K-C unit onto roll-bar.  
REPEAT for other side.



## G SEAT

**1** INSERT tabs on front of seat into slots in body.

**2** TILT seat backward.  
PUSH down to lock into place.

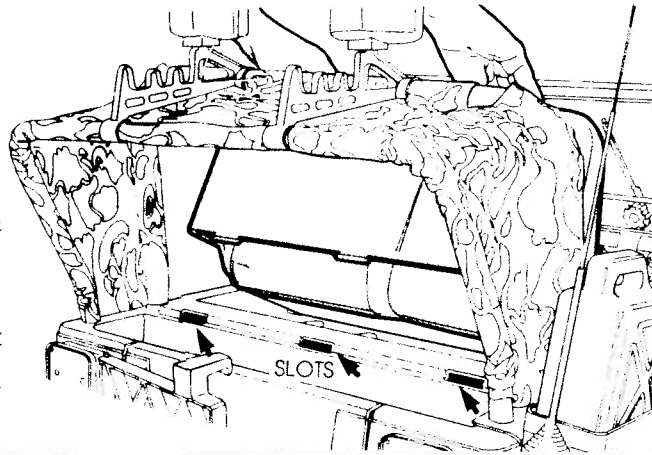
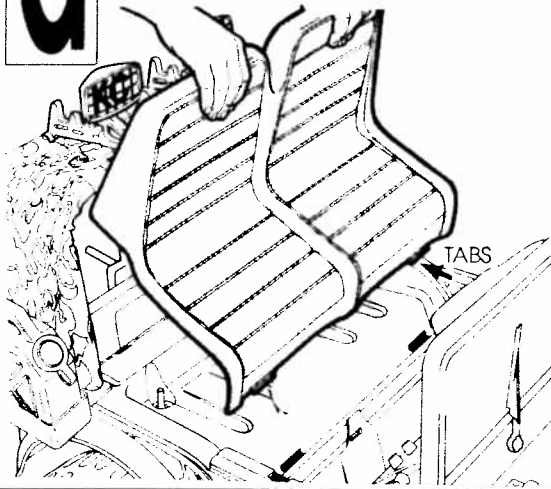

## H SPARE TIRE

**1** HAMMER retainer onto one end of spare tire rod.

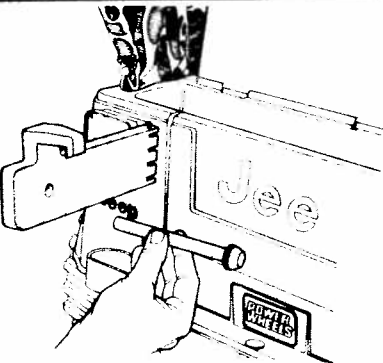
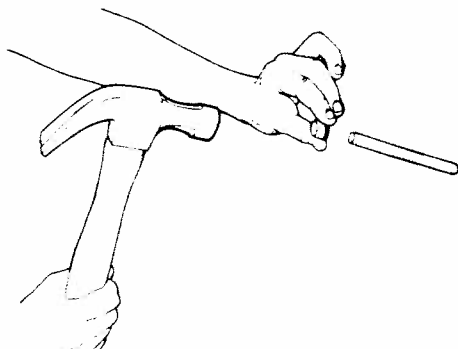

**2** INSERT spare tire rod through hole in back of spare tire bracket.

Note: Apply decal #8 to spare tire before this step.  
**3** PLACE spare tire onto spare tire rod.

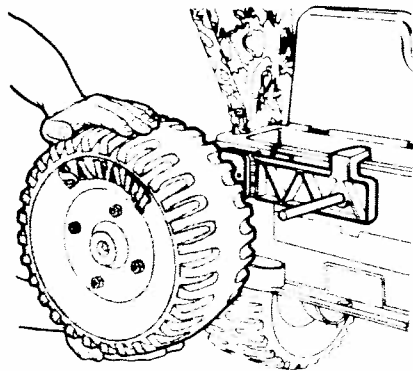

# HEADLIGHTS/MICROPHONE

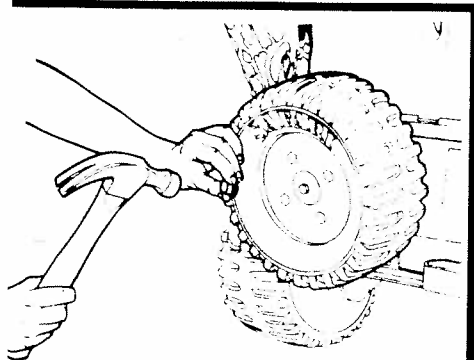

**4** HAMMER retainer onto end of spare tire rod.

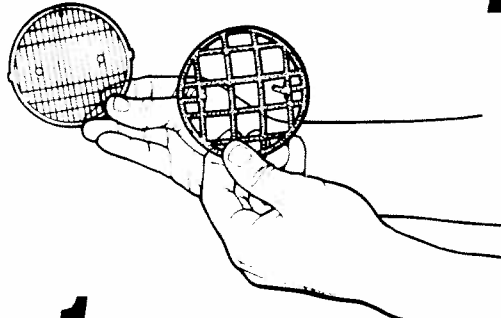

**1** SNAP headlight guards onto headlight lens.

**Note:** Apply decal #17 to headlight locations before this step.

**2** SNAP headlight lens into body. REPEAT for other side.

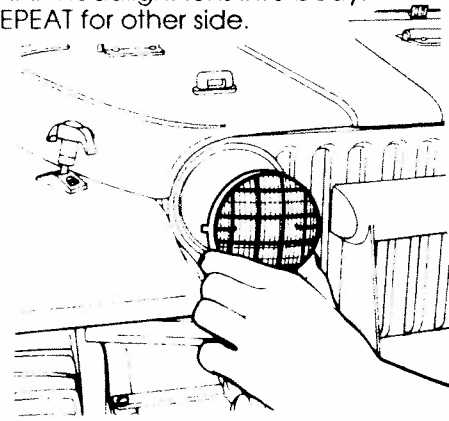

# HEADLIGHTS MICROPHONE CONT.

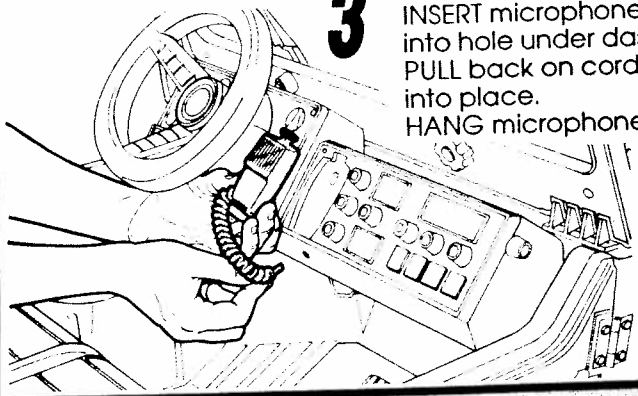

**3** INSERT microphone cord firmly into hole under dash. PULL back on cord to lock into place. HANG microphone on slot.

# BATTERY INSTALLATION

**1** OPEN hood. PLACE batteries into battery compartment with wires facing rear of vehicle.

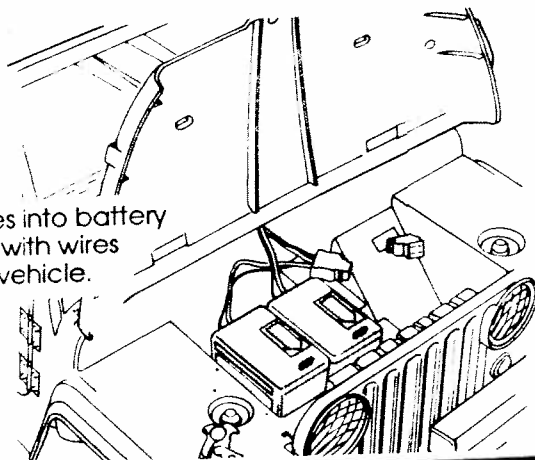

**2** PLACE pretend motor over batteries. THREAD battery connector and motor harness connector through holes.

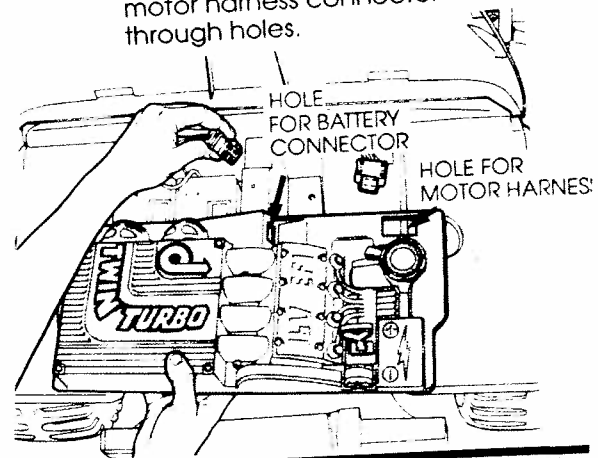

**3** SLIDE battery U-clip onto battery connectors.

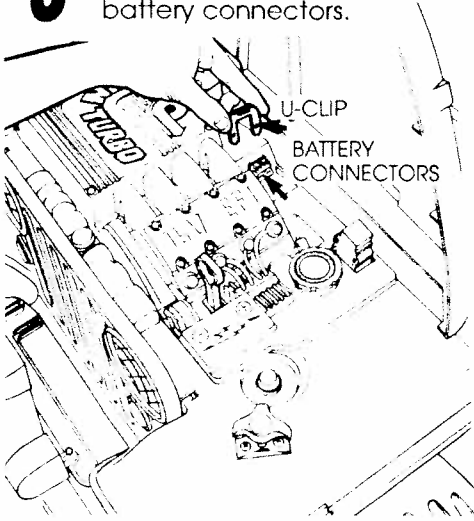

**4** REPLACE 1" screws in pretend motor (3 places).

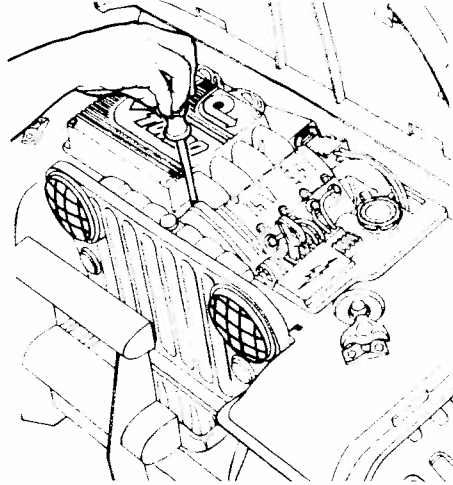

**5** PLUG black motor harness connector into red battery connectors. CLOSE hood.

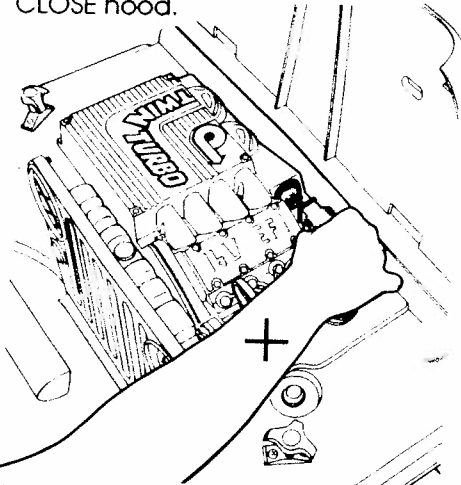

### IMPORTANT

Read Use and Care Manual for complete maintenance and riding instruction

### REMEMBER

THE FIRST TIME . . .

Charge the batteries for a minimum of **18** hours.

AFTER THAT . . .

Charge the batteries a minimum of **14** hours.

**NEVER** CHARGE THE BATTERIES OVER **30** HOURS.

### HIGH-SPEED CONNECTION

Your vehicle is now ready to go. For safety reasons, it will only operate in low speed.

To connect high-speed see Use and Care Manual.

