

CONTENTS NOTE: Letters for track pieces are not in sequence. Not every race set will use all track letters.



(3) 6" STRAIGHT



(2) 9" LANE CHANGER W/DECO



(1) 15" CUTOFF SQUEEZE



(2) 9" STRAIGHT



(2) 12" RADIUS 1/8



(15) 9" RADIUS 1/4 W/O DECO



(20) GUARDRAILS



(2) VEHICLES

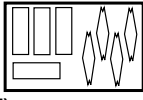

(5) FLAG DECAL SHEET

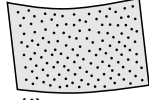

(1) SANDPAPER

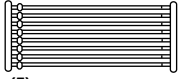

(5) FLAG POLE SETS

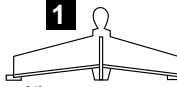

(4) NO.1 SUPPORTS

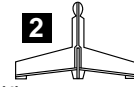

(4) NO.2 SUPPORTS

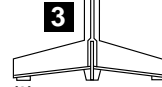

(3) NO.3 SUPPORTS

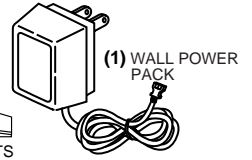

(1) WALL POWER PACK

TRACK LAYOUT

MAIN LAYOUT

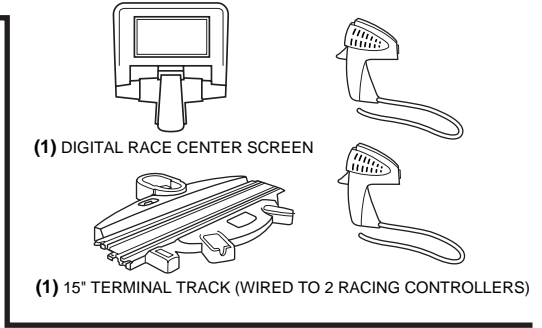
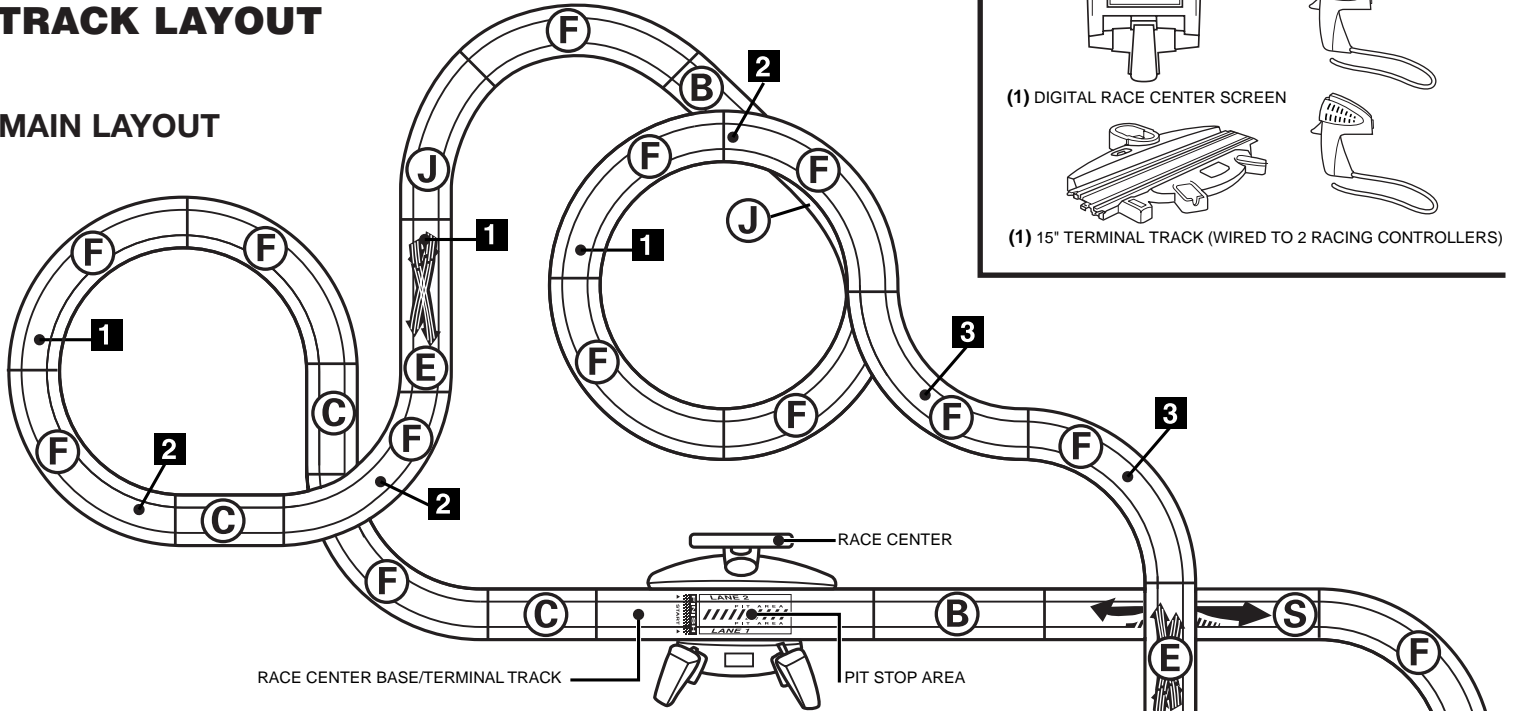

ALTERNATE 1

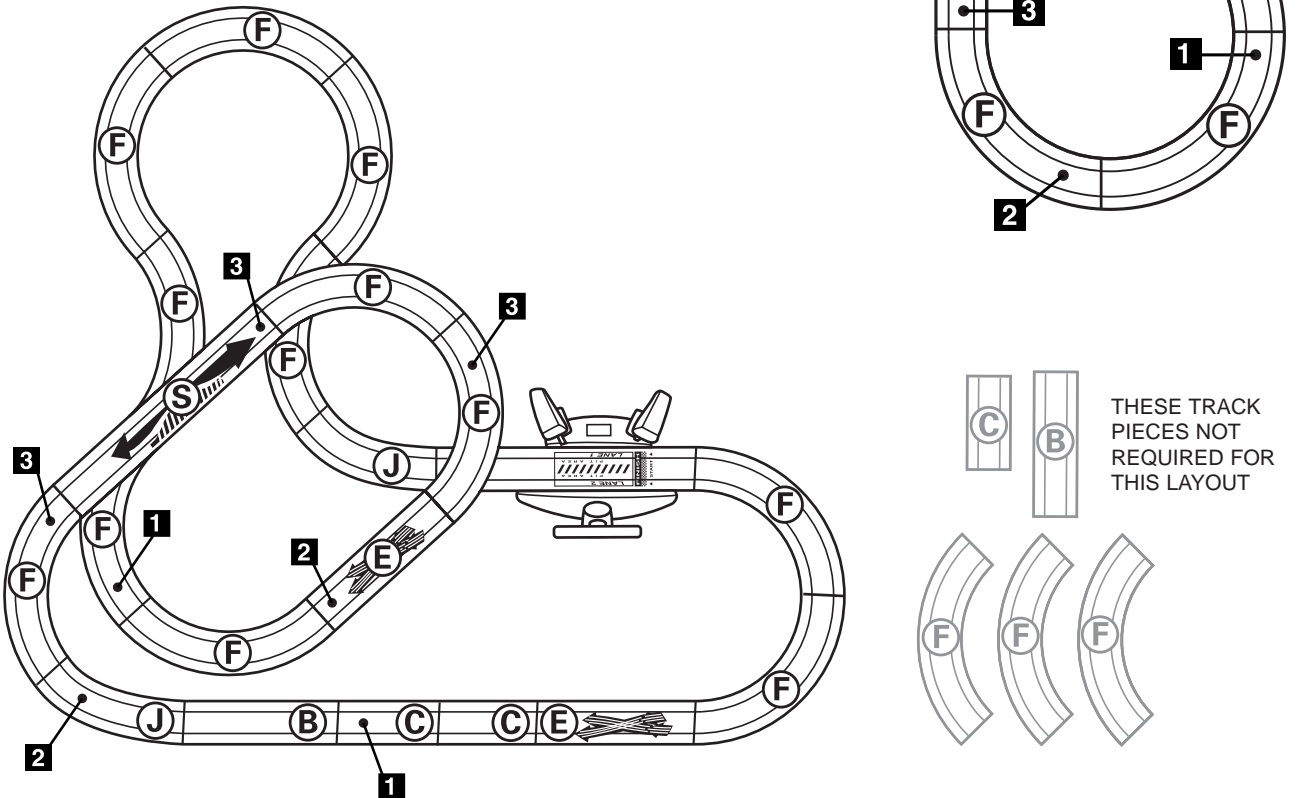

THESE TRACK PIECES NOT REQUIRED FOR THIS LAYOUT

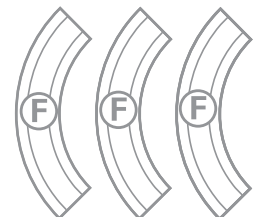

ALTERNATE 2

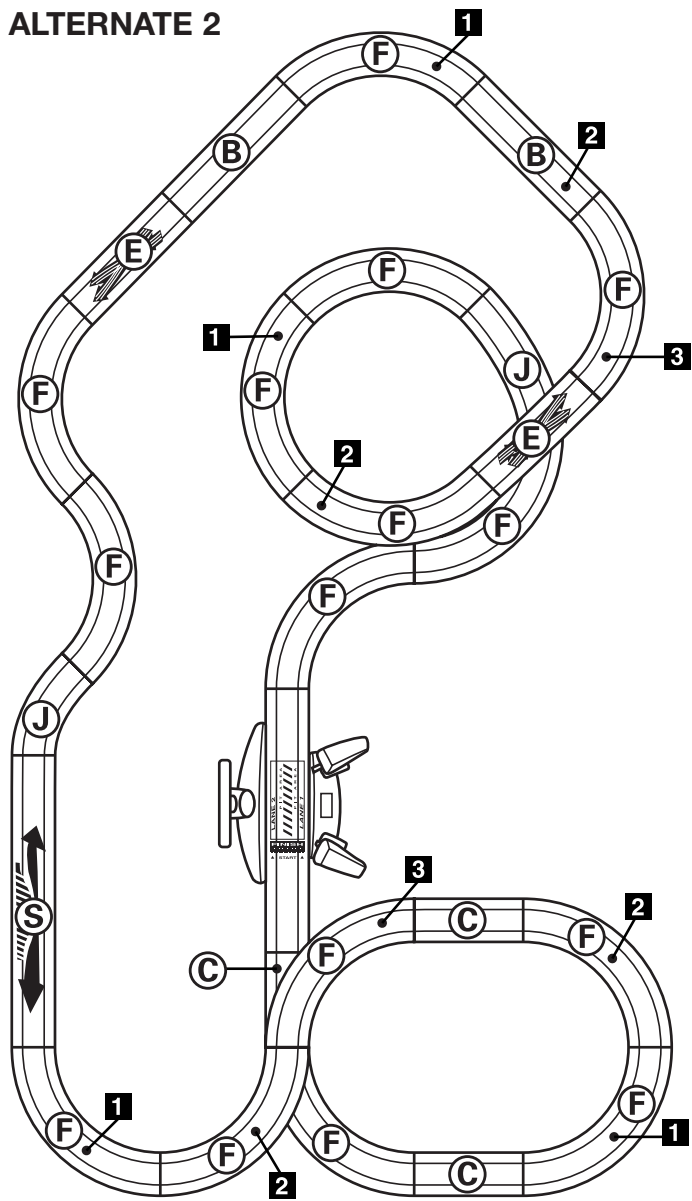

ALTERNATE 3

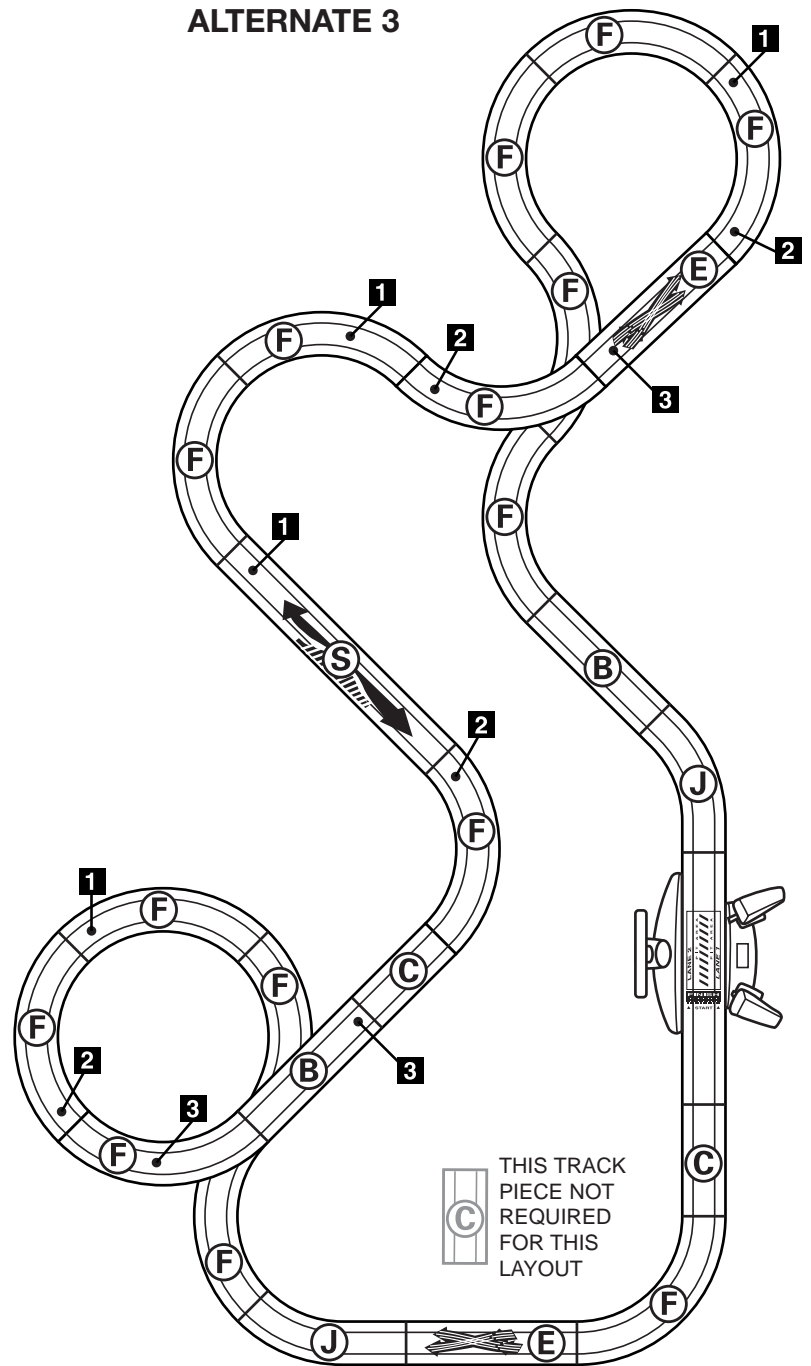

**ONE-YEAR LIMITED WARRANTY
HOT WHEELS® ELECTRIC RACING PRODUCTS**

Mattel, Inc. warrants to the original consumer purchaser that this product will be free of defects in material and workmanship for one (1) year (unless specified in alternate warranties) from the date of purchase. Mattel will repair or replace the product, at our sole option, in the event of such a defect within the warranty period.

In the event of a defect covered under this warranty, first call the toll-free number listed below. Many problems can be solved in this manner. If necessary, you will be instructed to return the product, postage prepaid and insured, to the address below. Enclose your name, address, dated sales receipt, and a brief explanation of the defect. Repair or replacement, and return shipment, will be free of charge. Please return only the defective part or unit, packed securely.

This warranty does not cover damage resulting from unauthorized modification, accident, misuse or abuse. If the product is returned without a dated sales receipt the product may be excluded from coverage under this warranty.

Mattel's liability for defects in material and workmanship under this warranty shall be limited to repair or replacement, at our sole option, and in no event shall we be responsible for incidental, consequential, or contingent damages (except in those states that do not allow this exclusion or limitation). This warranty is exclusive, and is made in lieu of any express or implied warranty. **Valid only in U.S.A.** This warranty gives you specific legal rights and you may have other rights, which vary from state to state. Some states do not allow the exclusion of incidental or consequential damages, so the above exclusions or limitations may not apply to you.

TOLL-FREE NUMBER: 1-888-557-8926
(valid only in U.S.A.)

Hours: 8:00 A.M. - 6:00 P.M. Eastern Time; Monday - Friday. Expect some delay in January following the holiday season. Please be patient and keep trying the toll-free number.

ADDRESS FOR RETURNS: CONSUMER RELATIONS, 636 GIRARD AVENUE, EAST AURORA, NY 14052

©2001 Mattel, Inc., Mt. Laurel, NJ 08054 U.S.A. **PRINTED IN CHINA.** All Rights Reserved. Mattel, Hot Wheels, flame logo and the color "Hot Wheels blue," and associated trademarks designated by © and ™ are U.S. trademarks of Mattel, Inc., except as noted. All other trademarks are used under license or with permission.





CAUTION-ELECTRIC TOY

NOT RECOMMENDED FOR CHILDREN UNDER 8 YEARS OF AGE. AS WITH ALL ELECTRIC PRODUCTS, PRECAUTIONS SHOULD BE OBSERVED DURING HANDLING AND USE TO PREVENT ELECTRIC SHOCK. MODEL 631S—INPUT: 120VAC, .125A, 60 Hz ONLY. OUTPUT: 15.0VDC, 7.5VA.

Please see "Special Note to Adults".

Keep these instructions for future reference, as they contain important information.

TECH RACE CHALLENGE™

The **TECH RACE CHALLENGE™** race set is the ultimate in interactive racing action! It combines the head-to-head competition of a classic stock car race with the high technology of a digital Race Center...for extra realism and excitement. This instruction sheet will tell you how to lay out your track, make your power connections and perform vehicle maintenance for top performance. The separate Race Center Instructions will tell you all about the super-cool features of the Race Center. Read 'em both...and then rip up the road!

PRE-RACE CHECKLIST

Like a **REAL** race driver, you've got to get ready for the big race! Take your time, follow these simple steps...and you'll be good to go!

ASSEMBLE YOUR TRACK

1 Start out on a clean, hard, flat racing surface – not carpeting. Spread out all the track pieces (and other parts) and check them against the contents list inside.

2 Follow the letters molded into each track piece – **it's easy!** Following the Track Layout inside, first lay out your track – without connecting any track pieces. That way you'll be able to see how the track layout goes together.

3 Now, carefully following the Track Layout, connect your track pieces! Working on the flat surface, push the ends of the track pieces together. (You may want to start with the terminal track and work your way around the curves.) Make sure they snap together securely – you'll hear a click when they're properly connected. Remember: if the track connections aren't right, electric power won't flow from one track section to the next.

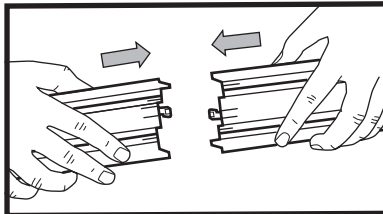

4 To disconnect track pieces, simply reach underneath where the track pieces meet and press the locking tabs together with thumb and forefinger as shown.

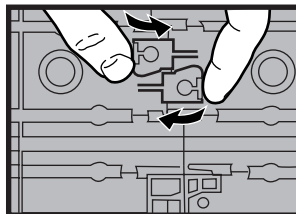

5 Guardrails help keep your car from spinning off on curves. They also add support for long "overpasses." Refer to the Track Layout for location of guardrails. To attach guardrails, carefully attach the bottom of the guardrail first. Then pull up and snap into place. Don't force guardrails into place.

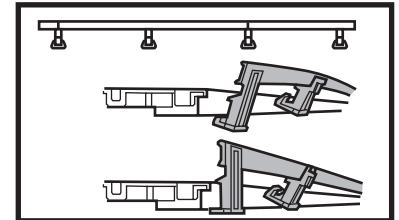

6 Your race set includes special racing flags and flagpoles. To attach them, carefully separate the flagpoles. Carefully cut a flag from the sheet and wrap it around each pole. Insert the flagpole into the guardrail as shown.

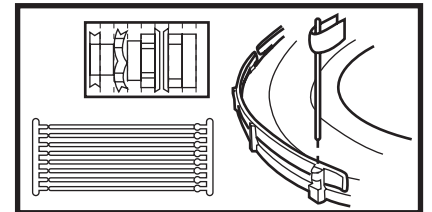

7 Your track layout includes several specially designed track supports. Refer to the Track Layout for location of track supports. To assemble the track supports, separate pieces as shown and remove connectors. Next, fit the two pieces together as shown. Insert the assembled track support into the round hole on the underside of the track.

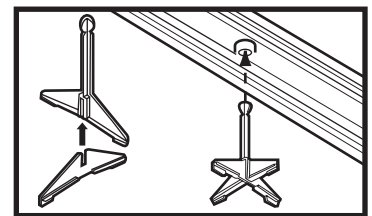
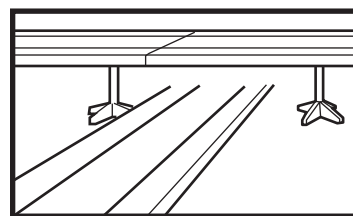
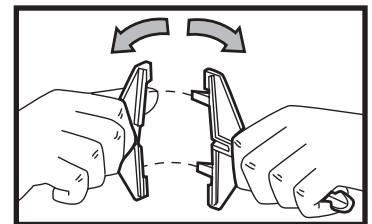

POWER CONNECTION

- **Always unplug your Power Pack when not in use!**
- **Race Center requires 3 “AA” alkaline batteries. Batteries not included.**

- 1 Hand Controllers (2) (permanently wired to Terminal Track)
- 2 Race Center
- 3 Red Power Pack Plug
- 4 Race Center Base/ Terminal Track
- 5 Mode Switch (Race Center ON/OFF)
- 6 Power Pack
- 7 Wall Outlet
- 8 Direction of Travel

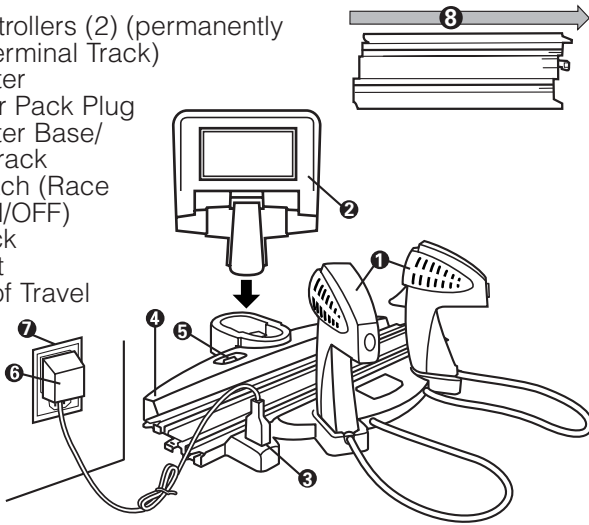

BATTERY INSTALLATION

Unscrew the battery door on the back of the Race Center. Install 3 “AA” alkaline batteries (not included) with polarity as shown inside battery compartment. Insert the Race Center into its receptacle in the Terminal Track, as shown. For longer life use only alkaline batteries. Please see Battery Safety Information.



Screwdriver required - not included

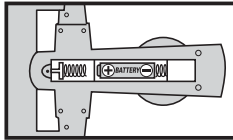

LOWER LEVEL

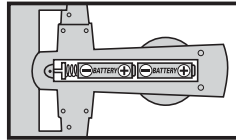

UPPER LEVEL

POWER PACK CONNECTION

- 1 Plug the Power Pack into a convenient wall outlet.
- 2 Plug the red Power Pack plug into the red receptacle on the terminal track. The hand controllers are permanently wired to the Terminal Track, and they can be stored in the track as shown. You can use the Mode Switch to turn the Race Center ON and OFF.
In this mode , you can race without the Race Center being activated...the way you would with a regular race set.
In this mode , the Race Center is turned on...for the ultimate interactive racing experience!
- 3 To test track and power connections. Make sure the Mode Switch is set to this position: . Then hold your car on the track with its metal contacts touching the metal track rails. Hold the front end of the car down while lifting the rear tires. Squeeze the hand controller: the car's tires should spin. If they don't, there's a connection problem. Carefully check the track and power connections.
- 4 Your hand controller is your car's “throttle.” The more you squeeze the trigger the faster your car will go. Practice at a slow speed for a few laps, until you're ready to race!

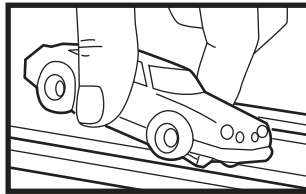

See “Cleaning Track” before racing.

MAINTENANCE

All “pro” racers know that their vehicles need maintenance from time to time...for best performance. Follow these simple steps to keep your car running at its best!

CHASSIS PARTS

This diagram will help you understand the parts of your vehicle, and how they go together.

- 1 Guide Pin
- 2 Front Tires
- 3 Rear Tires
- 4 Rear Axle Assembly
- 5 Contacts
- 6 Front Shaft
- 7 Springs

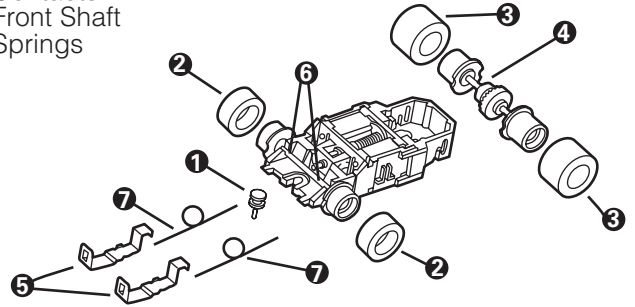

CLEANING TRACK

Clean track is IMPORTANT for best performance!

- 1 Small particles on the track may cause your vehicle to stall. Usually you can get it going again with a slight push. After 3-4 laps your vehicle will run properly.

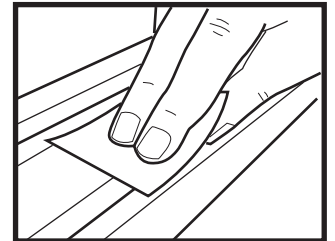
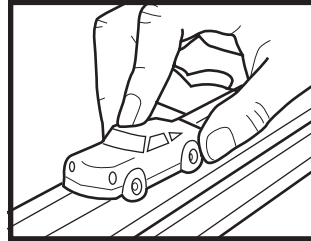

- 2 Sometimes oxidation may form on the track rails, and this may cause your car to stall. If this happens, you'll have to remove the oxidation. Using the supplied sandpaper, GENTLY rub the track rails. Don't rub hard – rails are clean when they're shiny. After cleaning, wipe the track with a soft, clean, lint-free cloth to remove any residue (don't use tissue or paper towels).

NEVER use steel wool to clean your track: severe damage can result if a fiber of steel wool is picked up by the magnets in your car's motor. Use only very fine sandpaper for cleaning. DO NOT clean with liquid.

OTHER MAINTENANCE

Check out these other important maintenance tips!

1 CLEANING TIRES

Dirty tires can cause your car to lose traction and spin. To clean the tires, place a piece of adhesive tape on a hard, flat surface, with the sticky side facing up. Roll the rear tires across the tape until they're clean.

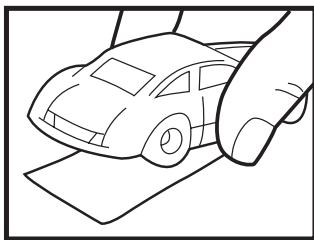

2 CLEANING AXLE

Lint may collect around your car's axles: this may cause the car to run slowly. Use tweezers or a toothpick to remove lint as shown.

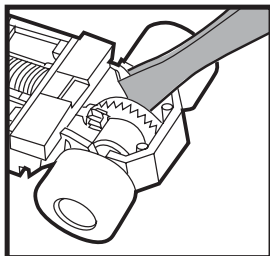

3 CLEANING CONTACTS

Regularly clean your car's contacts to remove oxidation. Using a pencil eraser, as shown, carefully scrub the contacts. Do not apply too much pressure, or you may bend contacts.

DO NOT USE STEEL WOOL. Worn-out contacts can be replaced; please call the toll-free number on page 6 for information

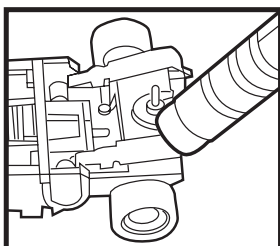

4 AXLE ALIGNMENT

Your car's axle assembly may become "dislocated" from the chassis as a result of a sudden impact. To realign it, snap the assembly back into the chassis. (If you put the rear axle in backwards, your vehicle will run in reverse.)

DO NOT use any type of tool to snap the chassis back in place. Use only your fingers.

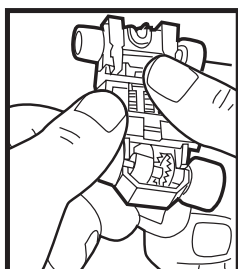

5 CHASSIS ALIGNMENT

Occasionally check the position of the car's body to make sure it is properly aligned and not rubbing against the tires. If necessary, carefully snap chassis back onto the body tabs, as shown.

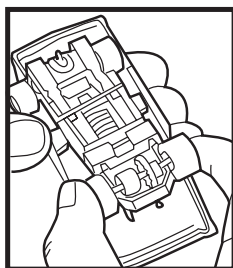

The high-tech vehicles in this race set are specially designed to work with the Race Center. "Standard" vehicle chassis will not work with the Race Center. If you want to use another current Hot Wheels® Electric Racing stock car vehicle with this set, you'll need to remove that vehicle's body and snap it onto the included vehicle's chassis. Please see "Chassis Alignment" on this page.

6 CONTACT REPLACEMENT

Your vehicle's contacts should last a minimum of 8-10 total hours of racing, with regular cleaning. You may need to replace the contacts if they become overly worn or bent...or if they become dislodged after an impact.

The best way to replace contacts is one at a time, using the remaining contact assembly as a guide.

a Hold chassis bottom side up. Hold the spring as shown (with your thumb on one side of the chassis and your forefinger on the other). You'll need to hold the spring securely throughout the assembly process.

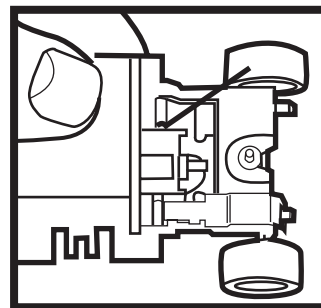

b Hook the narrow end of the contact under the motor shaft. Hook the curved side tab of the contact over the spring; the spring will be held in place by the curved tab. Snap the wide (slotted) end of the contact into place, with the chassis tab through the slot.

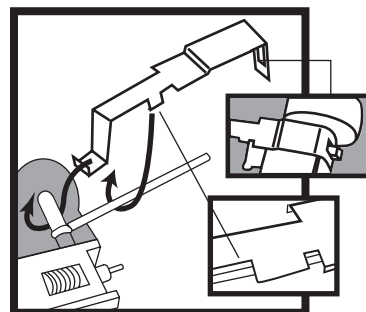

c Still holding the spring securely, turn the chassis over. You may need to press the top of the contact into place with the tip of a pencil. When properly installed, the contact will spring back when pushed.

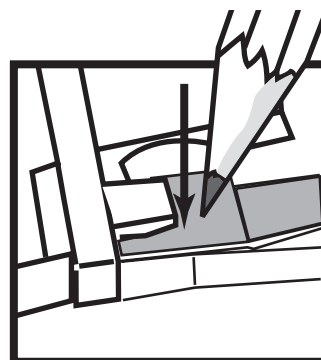

TIPS & HINTS

Here are some "inside" racing tips...for top performance and the fastest lap times!

1 Always race on a clean, hard, flat surface. For best racing performance, we don't recommend carpeting.

2 Clean track is IMPORTANT for best performance! Please refer to the Maintenance section (page 2) for detailed instructions for cleaning the track.

3 Races are won in the curves! Slow down going into the curves...then speed up coming out of them.

4 Anyone can be a "pro" racer – the secret is practice! Remember to "break in" your new cars with a few "qualifying" laps. Cars always run better after they've "warmed up."

5 In addition to competing against your friends, you can always practice your skills with a few hot laps against the clock. Set your own “course records” – then try to break them!

6 Experienced racers know that regular maintenance is the key to top racing performance. Read and follow the easy steps in the Maintenance section (page 2).

7 If you have questions or difficulty operating your Race Set, check the Troubleshooting Chart first. Usually a quick “pit stop” will get you racing again!

SPECIAL NOTE TO ADULTS:

- Always make sure your Race Set is unplugged before assembling or disassembling track.
- Always unplug Power Pack when not in use.
- Regularly examine for damage to the cord, plug, enclosure and other parts.
- In the event of any damage, this toy must not be used with the transformer until the damage has been repaired.
- Do not connect to more than the recommended number of power supplies.
- If this toy is being operated in the presence of children under 8 years old, adult supervision is recommended.
- This toy is not intended for children under 3 years old.
- This toy must be used only with the recommended transformer.
- The transformer is not a toy.

BATTERY SAFETY INFORMATION

- Insure that battery polarity is correct.
- Use only batteries of the type recommended (or equivalent).
- Do not mix old and new batteries.
- Do not mix alkaline, standard (carbon-zinc), or rechargeable (nickel-cadmium) batteries.
- Remove used-up batteries immediately. Remove batteries if vehicle will not be used for a long period.
- Do not recharge non-rechargeable batteries.
- Do not short-circuit terminals.
- Remove rechargeable batteries before recharging (if the batteries are designed to be removable).
- Recharge batteries only under adult supervision (if the batteries are designed to be removable).
- Dispose of batteries safely. Do not dispose of batteries (or products containing non-replaceable batteries) in fire, as batteries may explode or leak.

Battery Performance Note:

For best performance use alkaline batteries (where disposable batteries are called for). If your vehicle is supplied with standard (carbon-zinc) batteries for initial use and/or demonstration purposes, we recommend replacing them with alkaline batteries when necessary. Battery life may vary depending on battery brand.

TROUBLESHOOTING

PROBLEM	A TRACK CLEANING REQUIRED	B VEHICLE MAINTENANCE REQUIRED	C CHECK CONNECTIONS	D CHECK ALIGNMENT
VEHICLE STOPS OR WON'T RUN.	✓	✓	✓	✓
VEHICLE RUNS SLOWLY.	✓	✓	✓	✓
VEHICLE SPINS OUT.	✓	✓		

A TRACK CLEANING REQUIRED. You may need to clean the track. Follow the steps in the Maintenance section (page 2).

B VEHICLE MAINTENANCE REQUIRED. You may need to clean your vehicle’s tires, axle or contacts. Follow the steps in the Maintenance section (page 3), Numbers 1-3.

C CHECK CONNECTIONS. Check to make sure track pieces are properly connected – and power connection is correct. Refer to the Maintenance section (page 3).

D CHECK ALIGNMENT. Check to make sure your vehicle is properly aligned. Refer to the Maintenance section (page 2).