

# Fisher-Price®

# CBV76



**IMPORTANT!** Keep these instructions for future reference. Read these instructions before assembly and use of this product.



Adult assembly is required. Tools needed for assembly: Allen Wrench (included) and Phillips screwdriver (not included).

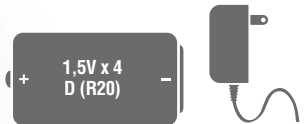

Requires four D (LR20) **alkaline** batteries (not included) or an AC adaptor (input 120 - 240 VAC, 50 - 60Hz, with an output of 6 VDC) for operation (included).

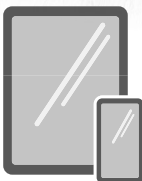

Some features of this product only work with the Fisher-Price® Smart Connect™ app. Download the Fisher-Price® Smart Connect™ app to control the swing from your smart device (not included). This app is available from the App Store<sup>SM</sup> or Google Play™.

[fisher-price.com](http://fisher-price.com)



# WARNING: Prevent serious injury or death:

- Never leave child unattended.
- This product is not intended for unsupervised or prolonged periods of sleep.
- Always use the restraint system.

## **When used as an infant rocker:**

- **Fall Hazard:** Never use on any elevated surface, since child's movement may cause the product to slide or tip over. Use only on a floor.
- **Suffocation Hazard:** Never use on a soft surface (bed, crib, sofa, cushion), since the product can tip over and cause suffocation.
- Never use with a child able to sit up unassisted.

## **When used as an infant swing:**

- **Prevent death:** Keep seat fully reclined until child is at least 4 months old **AND** can hold head up without help. Young infants have limited head and neck control. If seat is too upright, infant's head can drop forward and compress the airway, resulting in DEATH.

## **Prevent serious injury or death from falls or strangling in the restraint system:**

- Discontinue use when an active child attempts to climb out.

**IMPORTANT!** Maximum Weight Limit: 25 lb (11,3 kg). If your child weighs less than 25 lb (11,3 kg), but is really active and appears to be able to climb out of the swing, immediately discontinue its use.

- Use as an infant rocker from birth until child can sit up unassisted.
- Always use the swing where there is adequate ventilation. To prevent overheating, keep the swing away from heat sources such as radiators, heat registers, direct sunlight, stoves, amplifiers, or other appliances which produce heat.
- Never use extension cords with the AC adaptor.
- Never use the swing near water (ie.: bathtub, sink, laundry tub or wet basement, etc.).
- Do not connect to more than the recommended number of power supplies.
- The product must only be used with the recommended AC adaptor.
- The AC adaptor is not a toy.
- Disconnect the AC adaptor from the swing before cleaning.
- Product features and decorations may vary from photographs.

**Note:** This product may come with replacement warning labels which you can apply over the factory applied warning label if English is not your primary language. Select the warning label with the appropriate language for you.

# Parts



**Seat Base**



**2 Seat Side Rails**



**Seat Back**



**Body Support**



**2 Rocker Rails**



**Seat Bottom**



**Seat Pad**



**Swing Base**

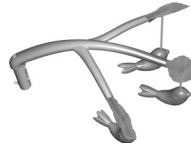

**Swing Mobile**



**Swing Base Cover**

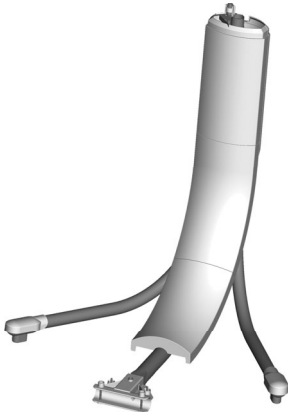

**Lower Swing Frame**



**Motorized Swing Frame**



**Swing Arm**



**AC Adaptor**



**Swing Power Cord Cover**



**Allen Wrench**



**#8 x 19 mm Screw - 14**



**M5 x 45 mm Bolt - 1**



**M5 x 38 mm Screw - 2**

**All fasteners shown actual size. Tighten and loosen the screws and bolt with the enclosed Allen wrench or a Phillips screwdriver.**

# Assembly

**IMPORTANT!** Before assembly and each use, inspect this product for damaged hardware, loose joints, missing parts or sharp edges. **DO NOT** use if any parts are missing or broken. Contact Fisher-Price® for replacement parts and instructions if needed. Never substitute parts.

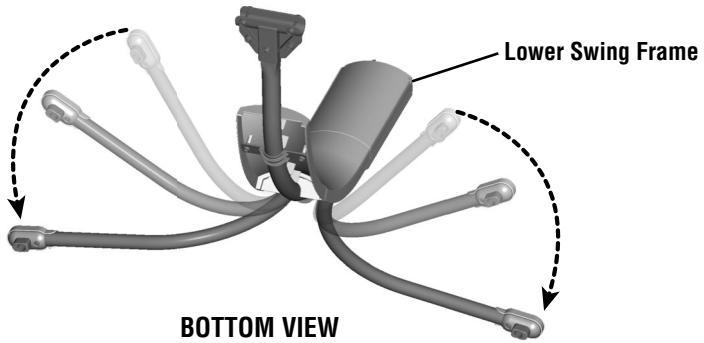

- Place the lower swing frame on its side on a flat surface.
- Pull each leg down. Make sure you hear a “**click**” on both sides.

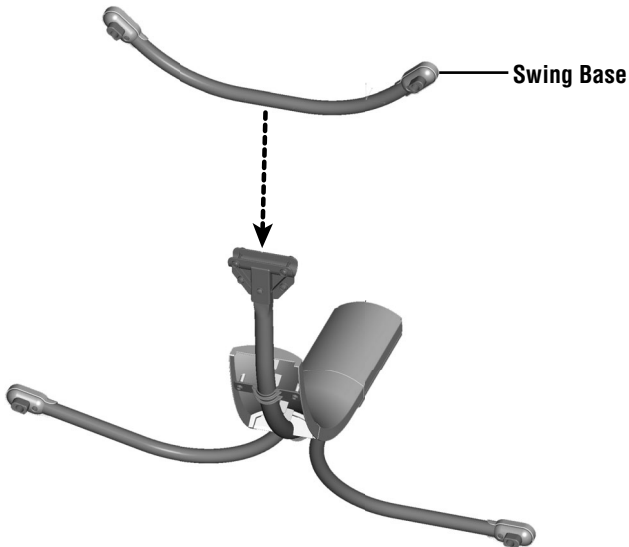

- Fit the swing base to the lower swing frame.

## Assembly

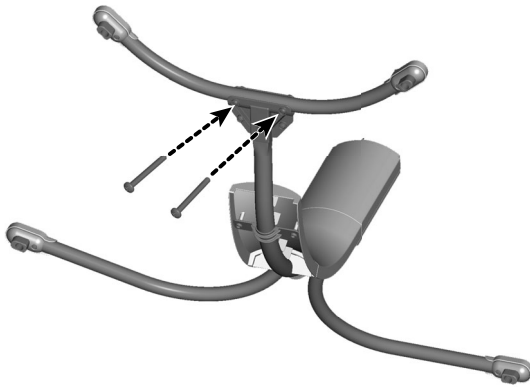

3

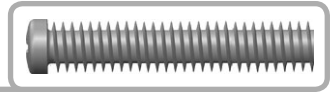

- Insert two M5 x 38 mm screws into the lower swing frame and tighten with a Phillips screwdriver.

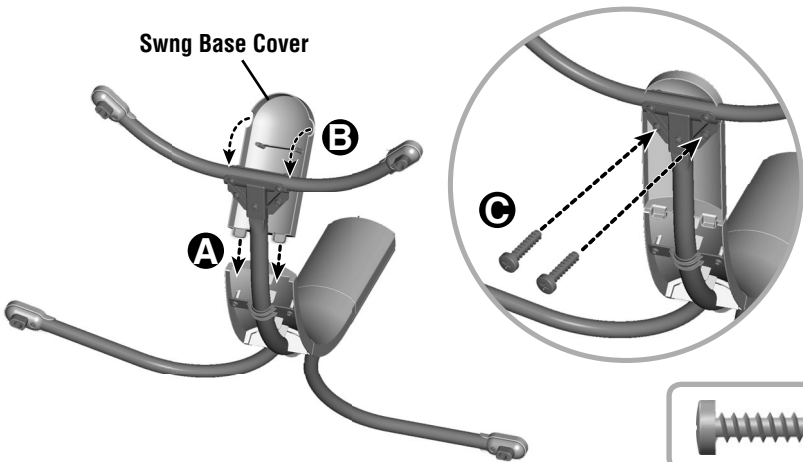

4

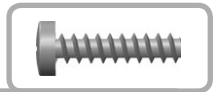

- At an angle, first insert the tabs on the swing base cover into the slots in the lower swing frame **A**.
- Then, fit the grooves in the swing base cover to the swing base **B**.
- Insert two #8 x 19 mm screws into the lower swing frame and tighten with a Phillips screwdriver **C**.

# Assembly

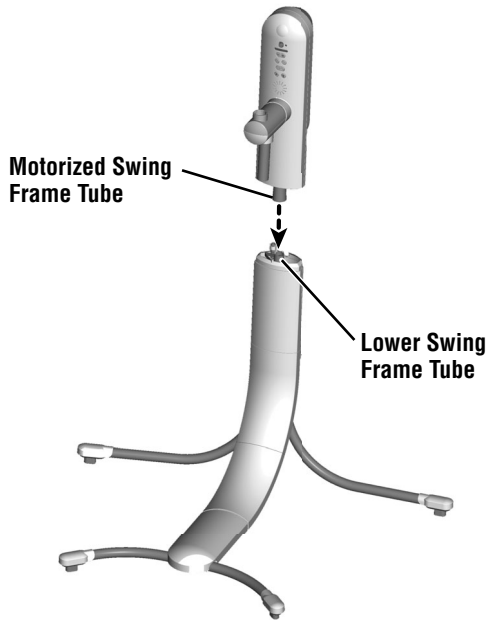

5

FRONT VIEW

- Turn the swing assembly upright.
- Fit the motorized swing frame to the lower swing frame. From the back of the swing assembly, make sure the button on the lower swing frame tube **“snaps”** into the hole in the motorized frame tube.

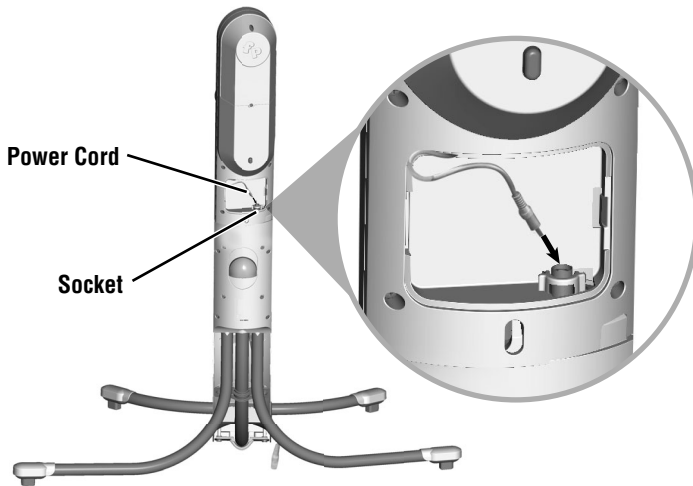

6

BACK VIEW

- From the back of the swing assembly, plug the power cord into the socket.

## Assembly

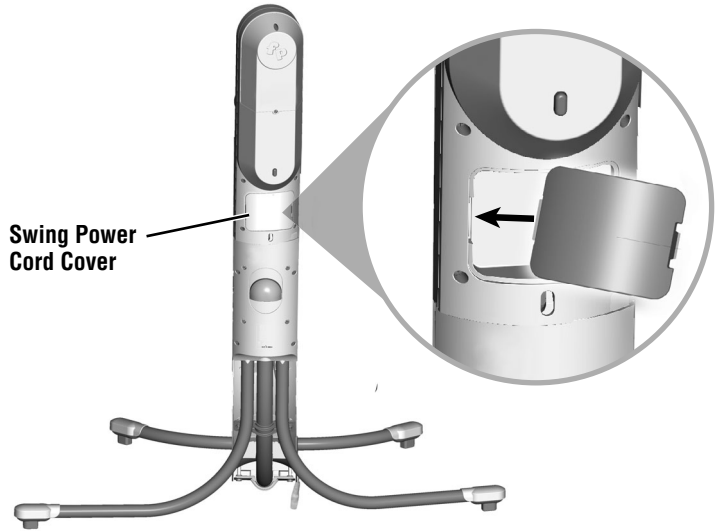

7

- Fit the tab on the swing power cord cover into the slot in the swing frame assembly. Push to “snap” in place.

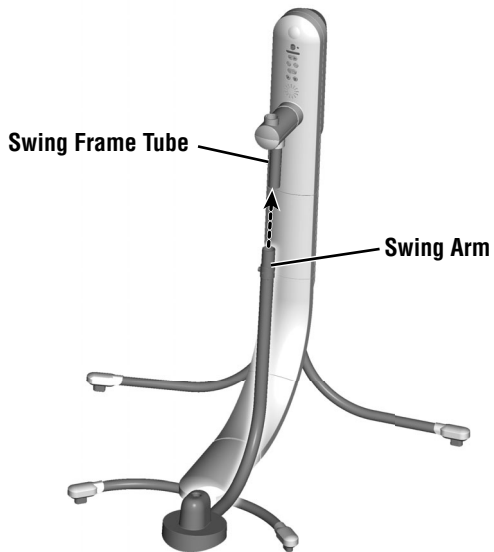

8

FRONT VIEW

- Fit the swing arm into the swing frame tube.

## Assembly

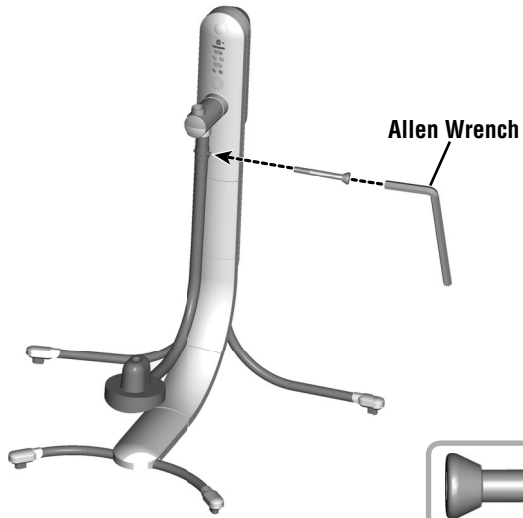

- Insert an M5 x 45 mm bolt into the swing arm and **fully tighten** with the Allen wrench.

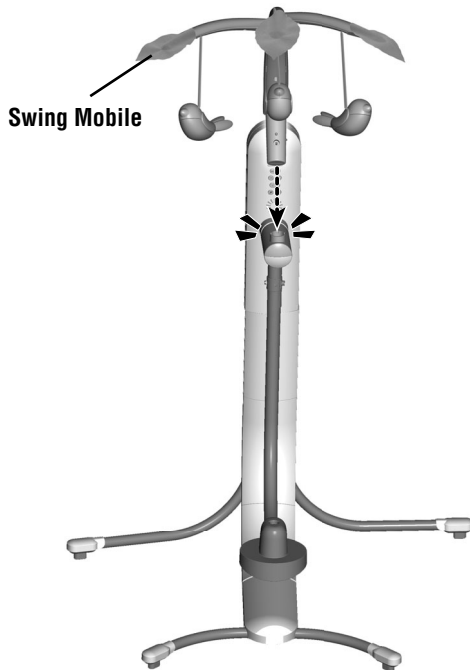

- **“Snap”** the swing mobile into the socket on the swing frame. Pull up on the mobile to be sure it's secure.



# Assembly

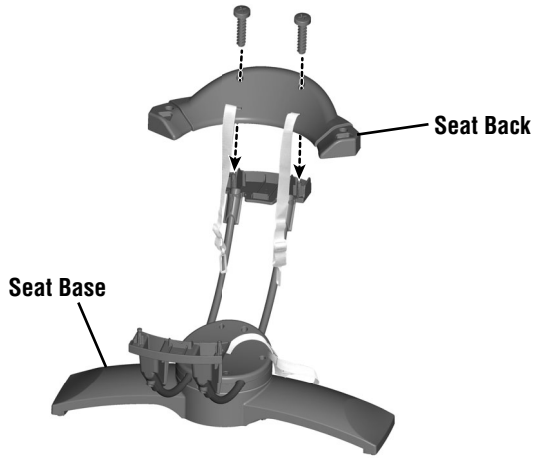

11

- Fit the seat back onto the tubes on the seat base.

**Hint:** The seat back is designed to fit onto the seat base one way. If it does not seem to fit, turn it around and try again, or try the other side of the seat base.

- Insert two #8 x 19 mm screws into the seat back and tighten with a Phillips screwdriver.

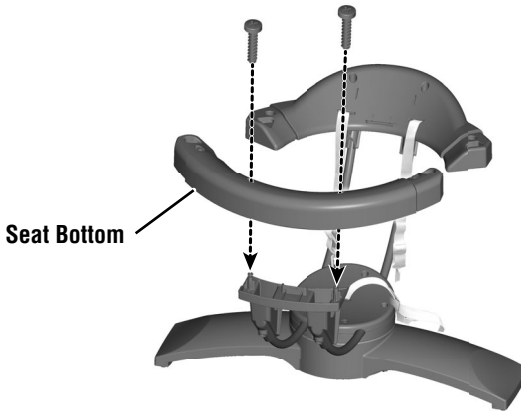

12

- Fit the seat bottom onto the seat base.

**Hint:** The seat bottom is designed to fit onto the seat base one way. If it does not seem to fit, turn it around and try again.

- Insert two #8 x 19 mm screws into the seat bottom and tighten with a Phillips screwdriver.

## Assembly

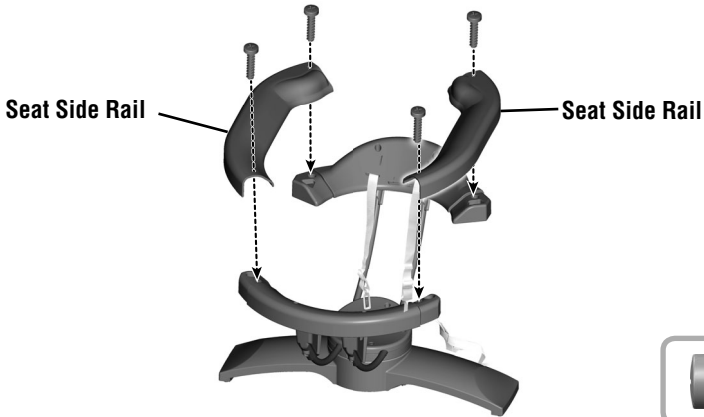

13

- Fit the seat side rails onto the seat assembly.

*Hint: The seat side rails are designed to fit one way. If they do not seem to fit, turn the seat side rails around and try again.*

- Insert four #8 x 19 mm screws into the seat side rails and tighten with a Phillips screwdriver.

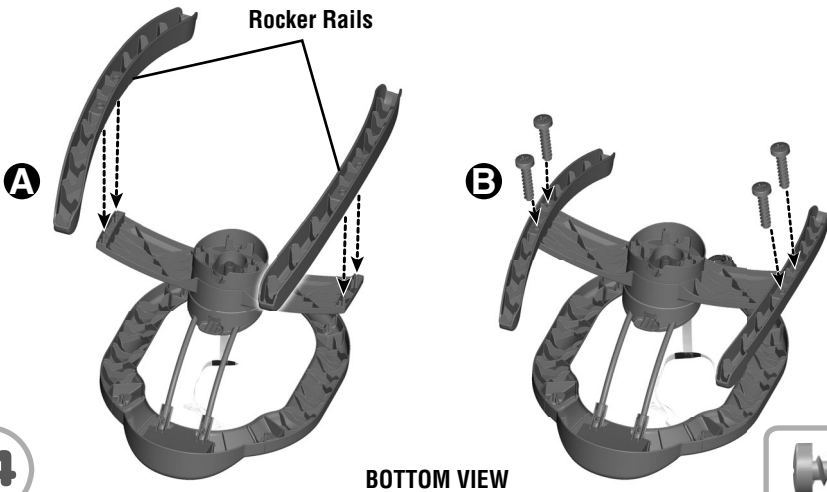

14

- Turn the seat assembly over.

- Fit the rocker rails onto the bottom of the seat assembly **A**.

- Insert four #8 x 19 mm screws into the rocker rails and tighten with a Phillips screwdriver **B**.

## Assembly

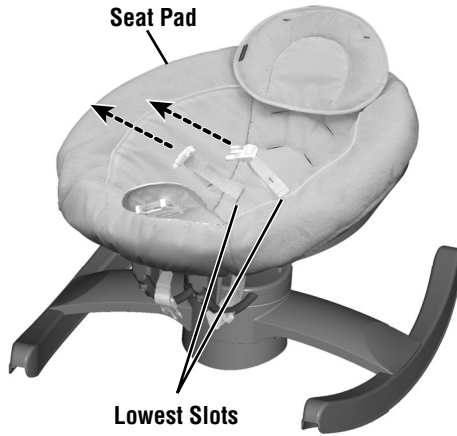

15

- Turn the seat assembly upright.
- Insert the seat waist belts through the **lowest slots** in the pad. Make sure the waist belts are not twisted.

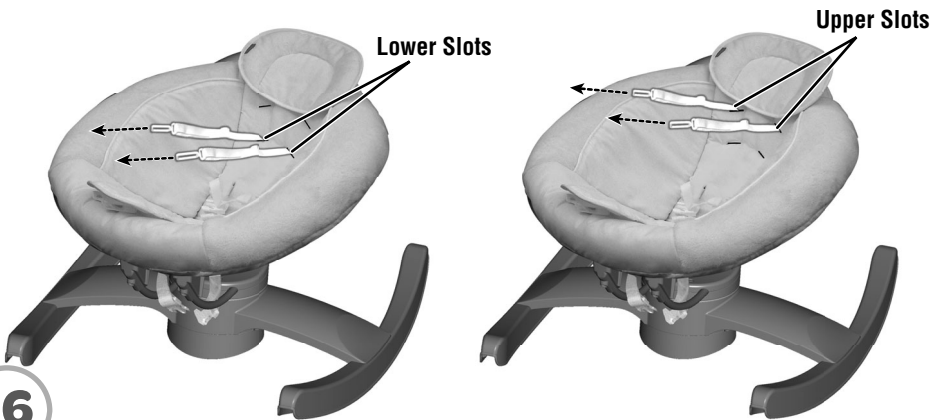

16

### Smaller Baby

- Insert the seat shoulder belts through the **lower slots** in the seat pad back.

### Larger Baby

- Insert the seat shoulder belts through the **upper slots** in the seat pad back.

## Assembly

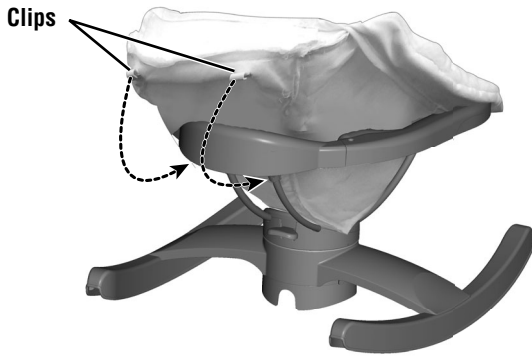

17

BACK VIEW

- Fit the clips on the top of the seat pad onto the seat back.

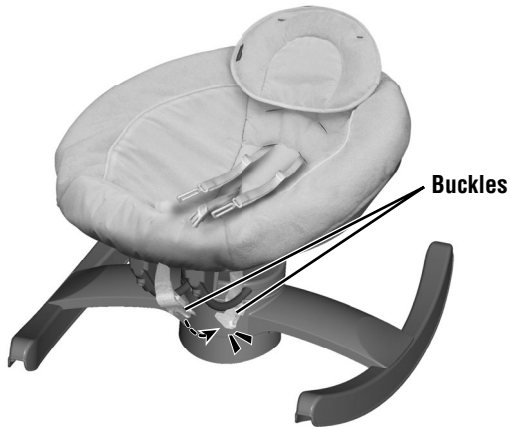

18

FRONT VIEW

- Fasten the buckles on the bottom of the seat pad. Make sure you hear a “click”.

## Assembly

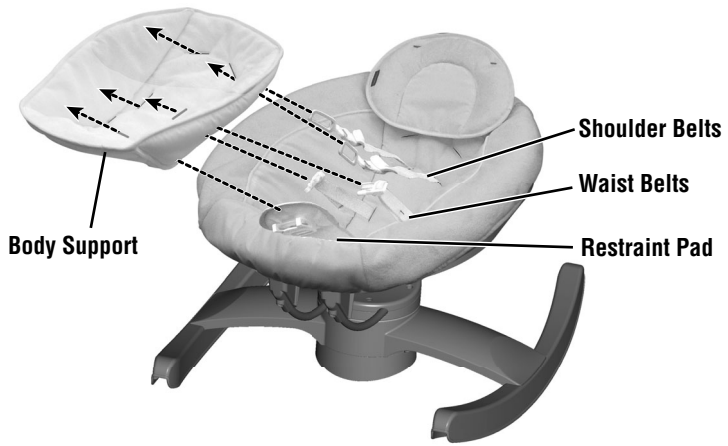

19

- Insert the restraint pad, waist and shoulder belts through the slots in the body support.

# Battery Installation

**Hint:** Install batteries if you need to use this swing away from an outlet. We recommend using **alkaline** batteries for longer battery life.

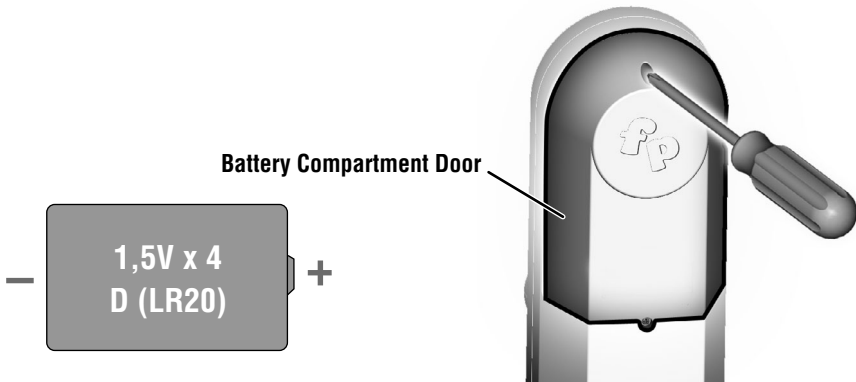

- Loosen the screws in the battery compartment door with a Phillips screwdriver and remove the battery compartment door.
- Insert four D (LR20) **alkaline** batteries into the battery compartment.
- Replace the battery compartment door and tighten the screws.

**Note:** Low battery power may cause product movement to slow, sound and lights to become faint or product to turn off all together. If this should happen, use the AC adaptor as a power source or replace the batteries. Replace the batteries with four D (LR20) **alkaline** batteries.

- If this product begins to operate erratically, you may need to reset the electronics. Turn the power off and then back on.



- Protect the environment by not disposing of this product with household waste (2002/96/EC). Check your local authority for recycling advice and facilities.

## Battery Safety Information

In exceptional circumstances, batteries may leak fluids that can cause a chemical burn injury or ruin your product. To avoid battery leakage:

- Do not mix old and new batteries or batteries of different types: alkaline, standard (carbon-zinc) or rechargeable (nickel-cadmium).
- Insert batteries as indicated inside the battery compartment.
- Remove batteries during long periods of non-use. Always remove exhausted batteries from the product. Dispose of batteries safely. Do not dispose of this product in a fire. The batteries inside may explode or leak.
- Never short-circuit the battery terminals.
- Use only batteries of the same or equivalent type, as recommended.
- Do not charge non-rechargeable batteries.
- Remove rechargeable batteries from the product before charging.
- If removable, rechargeable batteries are used, they are only to be charged under adult supervision.



## **WARNING:** **Prevent serious injury or death:**

- Never leave child unattended.
- This product is not intended for unsupervised or prolonged periods of sleep.
- Always use the restraint system.

### **When used as an infant rocker:**

- **Fall Hazard:** Never use on any elevated surface, since child's movement may cause the product to slide or tip over. Use only on a floor.
- **Suffocation Hazard:** Never use on a soft surface (bed, crib, sofa, cushion), since the product can tip over and cause suffocation.
- Never use with a child able to sit up unassisted.

### **When used as an infant swing:**

- **Prevent death:** Keep seat fully reclined until child is at least 4 months old **AND** can hold head up without help. Young infants have limited head and neck control. If seat is too upright, infant's head can drop forward and compress the airway, resulting in DEATH.

### **Prevent serious injury or death from falls or strangling in the restraint system:**

- Discontinue use when an active child attempts to climb out.

# Securing Your Child

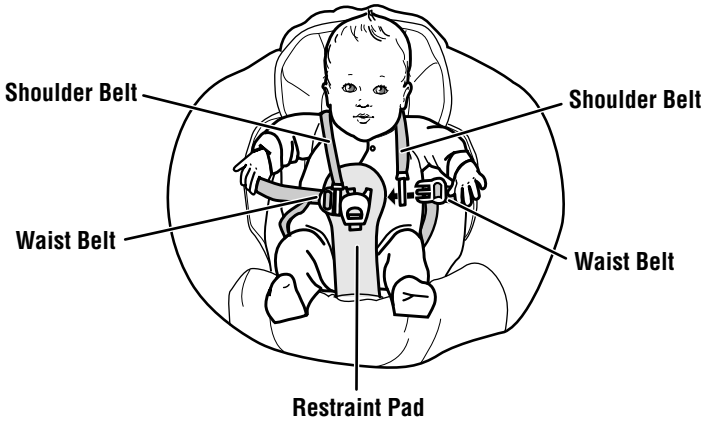

- Place your child in the seat. Position the restraint pad between your child's legs.
- Fit the end of each waist belt through the end of each shoulder belt.
- Fasten the waist/shoulder belts to the restraint pad. Make sure you hear a **"click"** on both sides.
- Check to be sure the restraint system is securely attached by pulling it away from your child. The restraint system should remain attached.

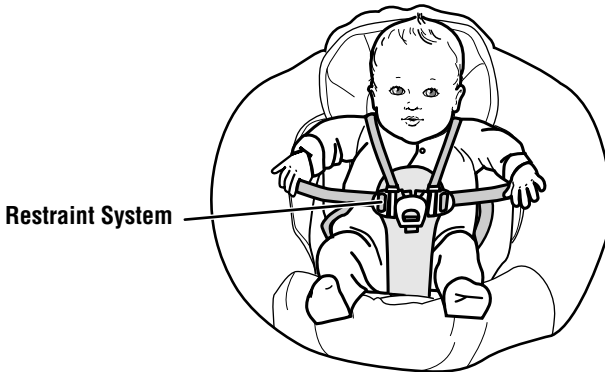

- Tighten each waist belt so that the restraint system is snug against your child. Please refer to the next section for instructions to tighten the waist/shoulder belts.



# Securing Your Child

3

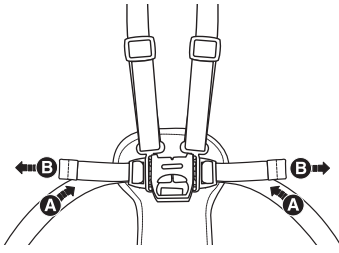

TIGHTEN

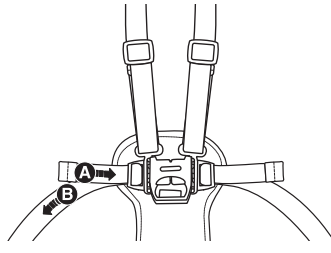

LOOSEN

- **To tighten the waist belts:** Feed the anchored end of the belt up through the buckle to form a loop **A**. Pull the free end of the belt **B**. Repeat this procedure to tighten the other belt.
  - **To loosen the waist belts:** Feed the free end of the belt up through the buckle to form a loop **A**. Enlarge the loop by pulling on the end of the loop toward the buckle. Pull the anchored end of the belt to shorten the free end of the belt **B**. Repeat this procedure to loosen the other belt.
- Note:** After adjusting the belts to fit your child, make sure you pull on them to be sure they are securely fastened.

4

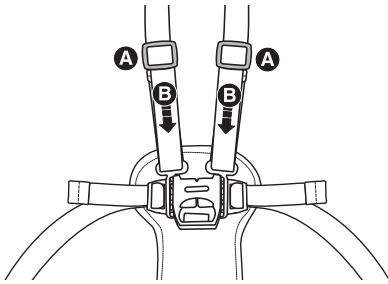

TIGHTEN

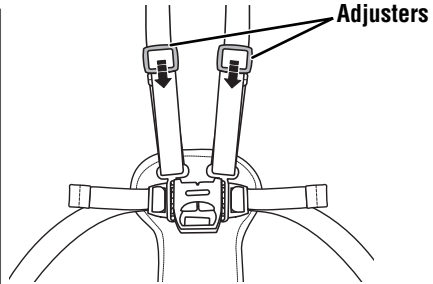

LOOSEN

- **To tighten the shoulder belts:**
  - Hold the adjuster **A** and pull the front shoulder strap down **B**.
- **To loosen the shoulder belts:**
  - Slide the adjuster down.

## Adjusting Seat Recline

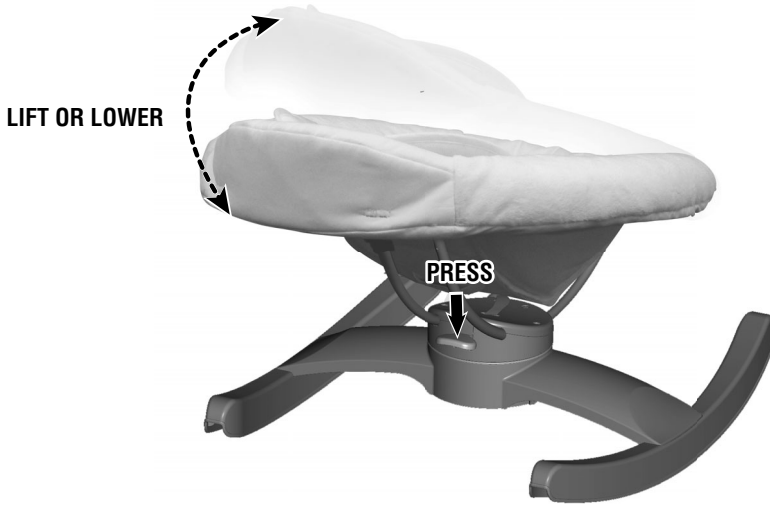

- 
- While pressing the button on the back of the seat, lift or lower the seat for upright or recline use.

## Rocker Seat

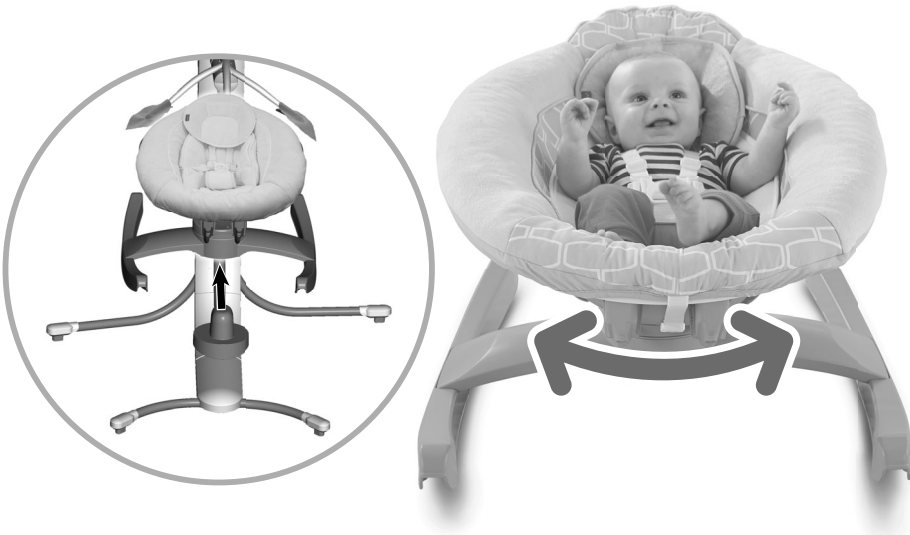

- 
- Lift to remove the seat from the swing arm.
  - Rotate the seat to change the rocking motion: rock head-to-toe or side-to-side. You should hear a “click” when the seat is in the correct position.

# Cradle Swing



- Place the seat onto the swing arm to use as a swing.
- Rotate the seat to change the swinging motion: swing side-to-side or head-to-toe. You should hear a “**click**” when the seat is in the correct position.
- Rotate the mobile to the left, center or right.

## Cradle Swing AC Power



- Place the swing near a standard wall outlet.
  - Plug the AC adaptor into the power cord extending from the back of a leg.
  - Plug the AC adaptor into the wall outlet.
  - Use the AC adaptor only in a wall outlet. Do not plug the adaptor into a ceiling outlet.
- Hint:** The power AC adaptor cord is designed to easily disconnect if stepped on accidentally. Simply plug the AC adaptor cord back into the power cord extending from the back of the leg.
- The swing also operates on battery power. To install batteries, please refer to the Battery Installation section on page 14.

# Cradle Swing



## Swing

- Slide the power switch ON.
- Press the swing speed buttons to select any of six speed settings. The swing speed LEDs light more for higher speeds and less for lower speeds.

*Hint: After turning on power, this product may not swing unless there is a child in the seat.*

- Be sure to turn the power OFF when not in use.

## Music, Sounds and Lights

- Press the music/sound selection buttons to play music and sounds. Press the same button again to turn the sound off. Press the same button again to turn the sound on again.

*Hint: Music or sounds will turn off after approximately 30 minutes. Press the music or sounds button to restart. When you restart music, a different song will play.*

- Press the volume buttons to adjust the volume level.
- Press the light button to turn the mobile light on. Press the button again to turn the lights off.

*Hint: The mobile has two lights and must be in the center position for the lights to work. If the lights do not turn on, try rotating the mobile.*

## Smart Connect™ App Download Information

- Some features of this product only work with the Fisher-Price® Smart Connect™ app.
- Download the Fisher-Price® Smart Connect™ app to control the swing from your smart device (not included). This app is available from the App Store<sup>SM</sup> or Google Play<sup>TM</sup>.
- The Smart Connect™ app is compatible with most iOS and Android devices. Please refer to the chart on the page 24 for a list of compatible devices. Device not included.

## Pairing Your Device

Before using the Smart Connect™ app for the first time, you will need to pair your device with the swing.



- 
- Open the Smart Connect™ app on your device. Be sure your device is within approximately six feet (1,8 meters) of the swing to pair.
  - Next, slide the swing power switch ON.
  - Then, press the pairing button on the back of the swing. The swing will stay in the pairing mode for approximately 30 seconds.
- Hint:** *If you cannot pair your device with the swing, try moving the device closer to the swing.*
- The swing icon will be active in the app when the swing is connected to your device. This indicates that you can use your device to control the swing.

# Smart Connect™ App

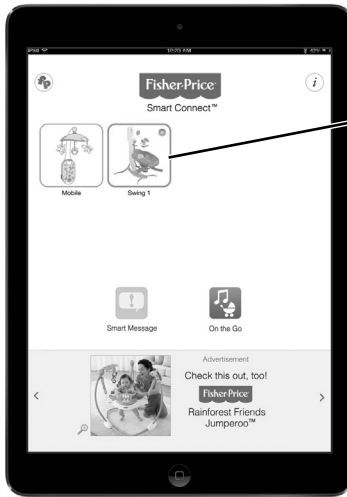

Open the Smart Connect™ app on your device. Then press the swing icon to open the swing controls.

Press to connect or disconnect your device from the swing.

Press to customize swing name.

View your device status here: ***You're Connecting, You're Connected, Another Device is Connected or Out of Range.***

Press to change the time out duration for the swing.

Press to change the time out duration for the music/sounds.

Press to adjust the volume level.

Press to turn sounds on or off.

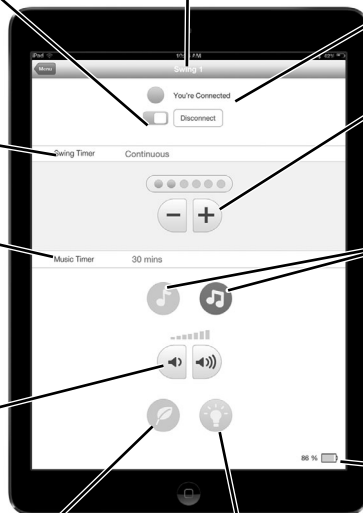

Press to choose the swing speed.

Press to turn music on or off.

This icon displays the battery life of your swing. When the battery icon turns red or is at 0%, use the AC adaptor as a power source or replace the batteries.

# Smart Connect™ App Compatibility

The Fisher-Price® Smart Connect™ app is compatible with the devices listed in the table.

APPLE	ANDROID
<ul style="list-style-type: none"><li>• iPhone (6 Plus, 6, 5S, 5C, 5 &amp; 4S)</li><li>• iPad (mini with Retina display, mini, air, 4th &amp; 3rd gen)</li><li>• iPod touch (5th gen)</li></ul>	<ul style="list-style-type: none"><li>• Google Nexus 5, Nexus 4</li><li>• Google Nexus 7 (2013), Nexus 10</li><li>• HTC One, One Max</li><li>• Motorola Droid (RAZR, Ultra, Maxx &amp; Mini)</li><li>• Motorola Moto G, X</li><li>• Samsung Galaxy S3 or newer</li><li>• Samsung Galaxy Tab 4, Pro, S or newer, Galaxy Note 3, Galaxy Note 8, 10.1, Pro 12.2, or newer</li><li>• Galaxy Mega</li><li>• Sony Xperia (SP, Z, ZR, ZL, Z1, Z Ultra HSPA+)</li><li>• Sony Xperia Tablet Z</li></ul>

As technology changes, this app may become compatible with additional devices. Visit [fisher-price.com/SmartConnect](http://fisher-price.com/SmartConnect) for an up to date, complete list of compatible devices.



# Care and Storage

## Care

- Unbuckle the restraint system.
- Remove the clips on the top of the seat pad back. Unfasten the buckles on the bottom of the seat pad.
- Remove the pad from the restraint system.
- Machine wash the pad and body support in cold water with a mild detergent. Do not use bleach. Tumble dry on low heat and remove promptly.
- To clean the seat, restraint system, mobile and swing frame use a mild cleaning agent and damp cloth. Rinse with clean water to remove residue.
- Replace the pad onto the seat.
- Periodically check the swing for loose fasteners or broken parts and tighten as needed.



**BACK VIEW**

- 
- Lift the lever on the back of the frame. Push the legs together.
  - Lean the swing frame against a wall for storage.
- IMPORTANT!** Remove the batteries for long-term storage.

**Adults Note:** If you use this product with the AC adaptor, periodically examine the AC adaptor for damage to the cord, housing or other parts that may result in the risk of fire, electric shock or injury. If the AC adaptor is damaged, do not use the product with the AC adaptor. Use batteries as the power source.

**Industry Canada (IC) Statement**

This device complies with Industry Canada license-exempt RSS standard(s). Operation is subject to the following two conditions: (1) this device may not cause interference, and (2) this device must accept any interference, including interference that may cause undesired operation of the device.

**Canada, avis d'Industry Canada (IC)**

Le présent appareil est conforme aux CNR d'Industrie Canada applicables aux appareils radio exempts de licence. L'exploitation est autorisée aux deux conditions suivantes: (1) l'appareil ne doit pas produire de brouillage, et (2) l'utilisateur de l'appareil doit accepter tout brouillage radioélectrique subi, même si le brouillage est susceptible d'en compromettre le fonctionnement.

Contains Transmitter Module FCC ID: CCT-CBV76-14, IC: 4390A-CBV76

# Consumer Information

## FCC STATEMENT (UNITED STATES ONLY)

This equipment has been tested and found to comply with the limits for a Class B digital device, pursuant to Part 15 of the FCC rules. These limits are designed to provide reasonable protection against harmful interference in a residential installation. This equipment generates uses and can radiate radio frequency energy and, if not installed and used in accordance with the instructions, may cause harmful interference to radio communications. However, there is no guarantee that interference will not occur in a particular installation. If this equipment does cause harmful interference to radio or television reception, which can be determined by turning the equipment off and on, the user is encouraged to try to correct the interference by one or more of the following measures:

- Reorient or relocate the receiving antenna.
- Increase the separation between the equipment and receiver.
- Connect the equipment into an outlet on a circuit different from that to which the receiver is connected.
- Consult the dealer or an experienced radio/TV technician for help.

**NOTE:** Changes or modifications not expressly approved by the manufacturer responsible for compliance could void the user's authority to operate the equipment.

This device complies with Part 15 of the FCC Rules. Operation is subject to the following two conditions: (1) This device may not cause harmful interference, and (2) this device must accept any interference received, including interference that may cause undesired operation.

This equipment complies with FCC radiation exposure limits set forth for an uncontrolled environment. End users must follow the specific operating instructions for satisfying RF exposure compliance. This transmitter must not be co-located or operating in conjunction with any other antenna or transmitter.

## CAN ICES-3 (B)/NMB-3 (B)

Operation is subject to the following two conditions: (1) this device may not cause interference, and (2) this device must accept any interference, including interference that may cause undesired operation of the device.

L'utilisation de ce dispositif est autorisée seulement aux conditions suivantes : (1) il ne doit pas produire de brouillage et (2) il doit pouvoir tolérer tout brouillage radioélectrique reçu, même si ce brouillage est susceptible de compromettre son fonctionnement.



## CONSUMER ASSISTANCE

1-800-432-5437 (US)



[service.fisher-price.com](http://service.fisher-price.com)

Fisher-Price, Inc., 636 Girard Avenue, East Aurora, NY 14052.

Hearing-impaired consumers/Clientes con problemas auditivos  
1-800-382-7470.



Apple, & the Apple logo are trademarks of Apple Inc., registered in the U.S. and other countries.

App Store is a service mark of Apple Inc.

Google Play is a trademark of Google Inc.

©2014 Mattel. All Rights Reserved. © and ™ designate U.S. trademarks of Mattel, except as noted.