



STREET HAWK™

REMOTE CONTROL FLYING CAR

DRIVE IT
FLY IT



8+

OUTDOOR USE RECOMMENDED.
ADULT ASSEMBLY REQUIRED.

Keep these instructions for future reference as they contain important information.

IMPORTANT: Please read all instructions before operating your vehicle.

⚠ CAUTION:

Surfaces may become hot and cause burns if electronics get wet.

Adult supervision is recommended when the vehicle is being operated.



CFG28-0920G1
CFG29-0920G1
Asst.BGK77

service.mattel.com

HOTWHEELS.COM

CONTENTS

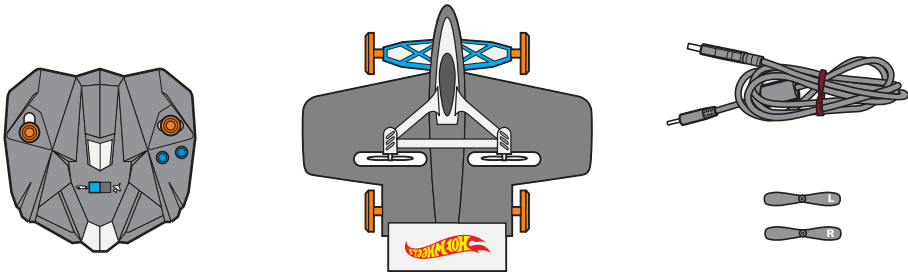

FEATURES

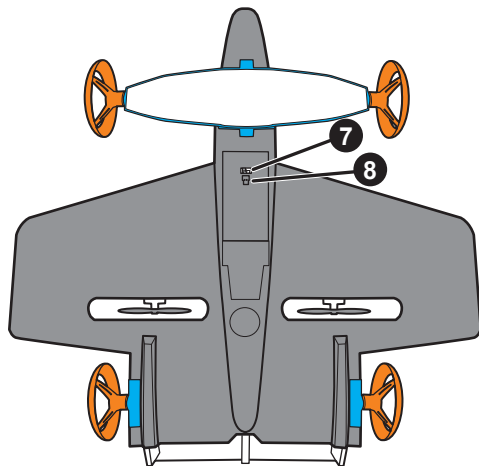
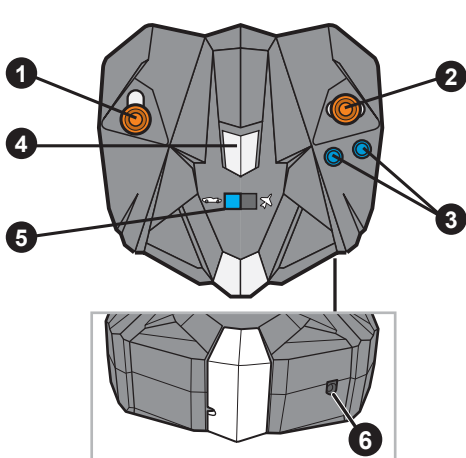

ABOUT THE TRANSMITTER

- 1 THROTTLE JOYSTICK** – Controls both motors and is used to make the vehicle move forward / ascend / descend.
- 2 STEERING JOYSTICK** – Controls the left and right motors independently to make the vehicle turn left / right.
- 3 ALIGNMENT ADJUSTMENT BUTTONS** – Use to correct the direction of the vehicle if it veers to either side.
- 4 TRANSMITTER POWER SWITCH**
 - Select (⚡) to charge the vehicle.
 - Select (O) to switch transmitter OFF.
 - Select (I) to switch transmitter ON.
- 5 GROUND (↔) / FLIGHT (✈) MODE SWITCH** – Use to select between Ground Mode and Flight Mode.
- 6 POWER CABLE SOCKET** – Use to charge the vehicle with the USB cable (included).

ABOUT THE VEHICLE

- 7 VEHICLE POWER SWITCH**
 - Select (O) to switch vehicle OFF.
 - Select (I) to switch vehicle ON.
- 8 CHARGING SOCKET** – Use to charge the vehicle's internal LiPo battery.

STREET HAWK™ HAS A SPECIALLY-DESIGNED DURAFORM™ BODY COMPRISED OF EXPANDED POLYPROPYLENE (EPP), MAKING IT LIGHTWEIGHT AND EXTREMELY RESILIENT FOR LONG-TERM DURABILITY.

SAFETY INFORMATION

Note to Adults: To ensure that the child's play is both safe and fun, please review all operating instructions and safety rules with your child.

- The toy is not intended for children under 8 years old.
- Keep fingers, hair and loose clothing away from the propellers while the vehicle is switched ON.
- Stay at least 3 to 6 feet away from the vehicle. That goes for anyone watching as well.
- Always keep an eye on the vehicle. If it looks like it's going to crash into you, your friends or anything else, release the throttle joystick and step out of the way.
- Never disassemble or attempt to modify the vehicle.
- When not in use, turn off vehicle and then transmitter. To avoid accidental operation, remove batteries in transmitter.
- Operating range of transmitter is 200 ft. (60m).

SET UP

1. TRANSMITTER BATTERY INSTALLATION

1. Unscrew the battery cover with a Phillips head screwdriver (not included).
2. Install 6 AA (LR6) alkaline batteries (not included) with polarity (+/-) as shown inside the battery compartment.
3. Replace battery cover and tighten screws.
4. Replace batteries in the transmitter if the vehicle runs slowly after a recharge or if you see a green light flashing in the transmitter power switch.

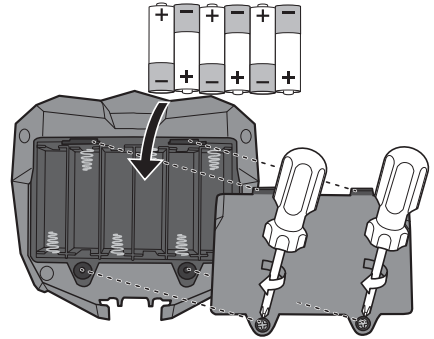

2. CHARGING THE VEHICLE

MUST CHARGE VEHICLE BEFORE FIRST USE. CHARGE TIME IS APPROXIMATELY 40 MINUTES OR MORE.

Your vehicle is powered by a LiPo battery that is permanently installed. The vehicle must be charged before play. It can be charged with the transmitter or with the USB cable.

CHARGING WITH THE TRANSMITTER

1. To charge, first make sure you have installed 6 AA alkaline batteries in the transmitter and that both the transmitter and vehicle are switched OFF (○).
2. Open the cover on the transmitter and take out the charging cable (see ④).
3. Insert the charging plug firmly into the socket under the vehicle. Make sure the connection is secure (see ⑤).
4. To begin charging, move the transmitter power switch from OFF (○) to CHARGE (⚡). A red light in the power switch will turn on. This indicates the vehicle is charging. (see ⑥).
5. The charging process takes approximately 40 minutes or more. The red light will go off when charging is complete.
6. Hold the charging plug and gently pull it out of the socket. NEVER pull on the cable as this may cause the cable to break.
7. Replace the charging cable into the transmitter and close the cover.
8. The vehicle will usually have about 5-6 minutes of flight time once fully charged.

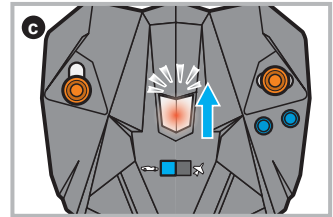
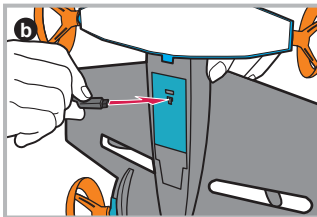
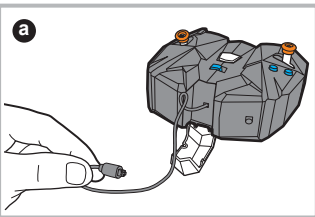

CHARGING WITH THE USB CABLE

1. Connect the transmitter to a powered USB port with the supplied USB cable.
2. Follow the same instructions as detailed in CHARGING WITH THE TRANSMITTER.
3. Remember to disconnect the USB cable from the transmitter before play.

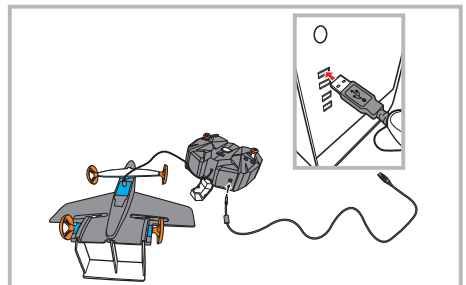

LiPo(LITHIUM POLYMER) BATTERY INFORMATION

- **FULLY CHARGE THE BATTERY BEFORE STORING FOR AN EXTENDED PERIOD OF TIME (6 MONTHS OR LONGER). PERIODIC CHARGING EVERY FEW MONTHS IS RECOMMENDED TO EXTEND BATTERY LIFE WHEN NOT IN USE. DO NOT STORE NEAR HEAT OR IN DIRECT SUNLIGHT.**
- DO NOT DISASSEMBLE THE VEHICLE'S PERMANENTLY INSTALLED LiPo (Lithium Polymer) BATTERY. IT IS A SEALED LiPo BATTERY. TO PROPERLY RECYCLE, FOLLOW LOCAL LITHIUM POLYMER BATTERY RECYCLING GUIDELINES.
- DO NOT RECHARGE THE VEHICLE IF IT FEELS HOT. ALLOW IT TO COOL BEFORE RECHARGING.
- VEHICLE IS ONLY TO BE CHARGED USING THE TRANSMITTER/CHARGER SUPPLIED. DO NOT CHARGE THE LiPo BATTERY IN ANY OTHER BATTERY CHARGER.
- DO NOT ATTEMPT TO USE OR CHARGE THE VEHICLE IF IT SHOWS SIGNS OF LEAKAGE OR CORROSION.
- IF THE VEHICLE AND/OR TRANSMITTER ARE WET, THOROUGHLY DRY BEFORE USING OR CHARGING.
- REGULARLY EXAMINE ALL WIRES AND CONNECTORS. IN THE EVENT OF DAMAGE, DISCONTINUE USE.

3. PAIRING THE TRANSMITTER AND VEHICLE

You must pair the transmitter with the vehicle before you can control it. FIRST SWITCH ON THE VEHICLE, THEN IMMEDIATELY SWITCH ON THE TRANSMITTER. The transmitter power switch changes from a flashing green light to a solid green light when pairing is complete. If the green light does not stop flashing after a few seconds, switch off the transmitter and vehicle, then try again.

NOTE:

WHEN PLAYING WITH MULTIPLE VEHICLES, EACH MUST BE PAIRED ONE AT A TIME. A maximum of 6 vehicles can be paired in one location.

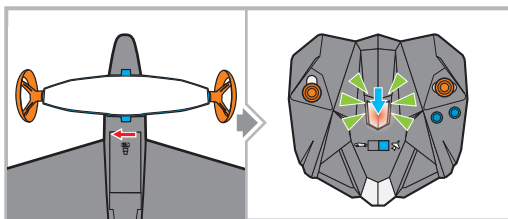

4. ALIGNMENT ADJUSTMENT

It is recommended that you check the vehicle's alignment before playing.

Ground Mode

1. Switch transmitter to GROUND (🚗) Mode.
2. Push the throttle joystick forward to see if the vehicle will drive straight.
3. If the vehicle veers right, stop the vehicle and press the left alignment adjustment button 2 or 3 times.
4. If the vehicle veers left, press the right alignment adjustment button 2 or 3 times.
5. Repeat steps 3 or 4 until the vehicle can travel in a straight line.

Flight Mode

1. Switch transmitter to FLIGHT (✈️) Mode.
2. Push the throttle joystick forward until the vehicle takes off.
3. The vehicle may veer to one side because of wind or turbulence. Use the steering joystick to make the vehicle fly straight and level and then let go of the joystick.
4. Observe the vehicle and see if it will fly straight or veer to one side.
5. If the vehicle veers right, stop the vehicle and press the left alignment adjustment button 2 or 3 times.
6. If the vehicle veers left, press the right alignment adjustment button 2 or 3 times.
7. Repeat steps 5 or 6 until the vehicle can fly in a straight line.

NOTE:

Alignment adjustment settings reset when transmitter is switched off and will need to be checked before each use. The alignment adjustment button can be pressed a maximum of 15 times in either direction.

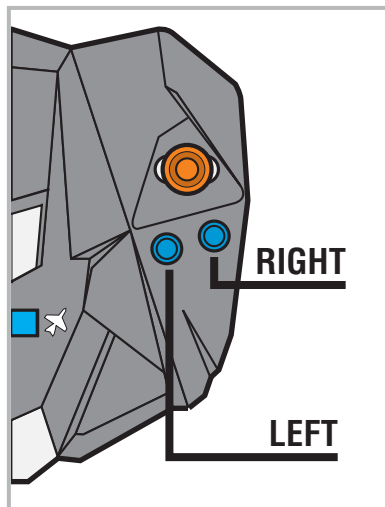

GROUND MODE

DRIVING THE VEHICLE

Switch transmitter to GROUND (🚗) Mode.

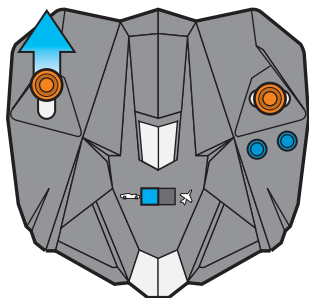
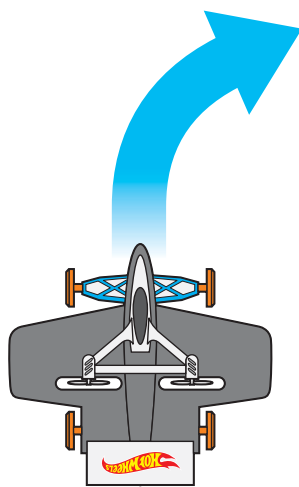
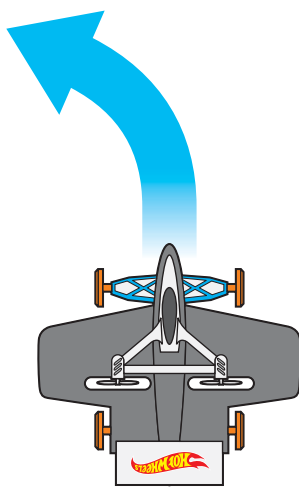
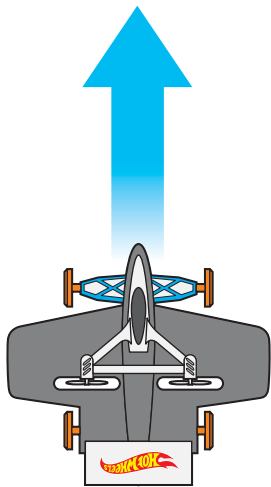

FORWARD

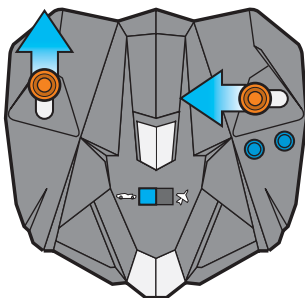

FORWARD LEFT

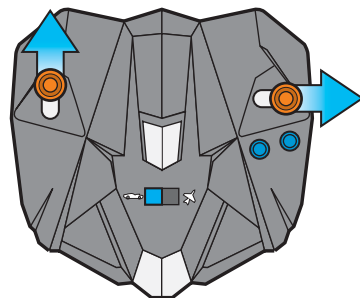

FORWARD RIGHT

NOTE:
The vehicle drives best on flat, smooth surfaces. Avoid driving through wet areas.

FLIGHT MODE

PRE-FLIGHT CHECK

1. Give yourself plenty of flying room. For best results, operate vehicle in a wide open area.
2. Avoid buildings, trees and power lines as they may obstruct your flight path.
3. **PLAY SAFELY** – Do not drive or fly vehicle in the street! Watch out for people, animals and obstacles.
4. **DO NOT** attempt to operate your vehicle in strong winds. Wind will make it difficult to fly safely and will reduce battery life and flying time. Remember that the wind may be stronger higher up in the sky than at ground level.

FLYING THE VEHICLE

Switch transmitter and vehicle on, synchronize them and then select FLIGHT (✈️) Mode.

Taking Off: Place the vehicle on the ground and stand behind it. Push the throttle joystick completely forward until the vehicle begins to take flight. If the plane veers right or left during take off, push the steering joystick to the opposite direction to keep moving forward. Once you've reached your desired altitude, slowly pull back on the throttle joystick to level off.

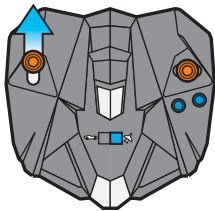
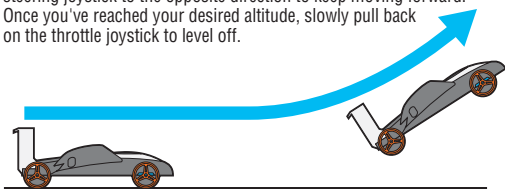

Maintaining Flight: To increase altitude, push the throttle joystick forward.

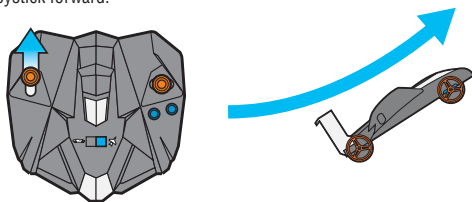

To decrease altitude, slowly pull back on the throttle joystick.

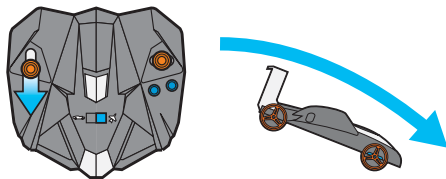

Steering: Keep the throttle joystick still and slowly push the steering joystick left or right. Return the steering joystick to the center position once the vehicle is flying in the direction you want.

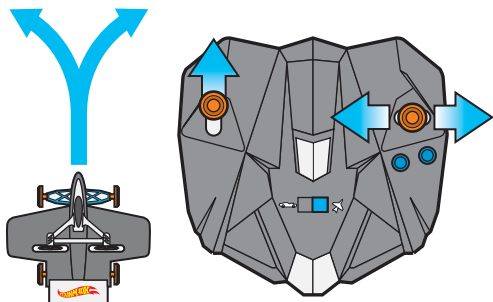

Landing: Pull back on the throttle joystick and the vehicle will descend. Just before the vehicle touches the ground, push the throttle joystick forward a little and then let go. This will level the vehicle off so it does not crash nose first into the ground.

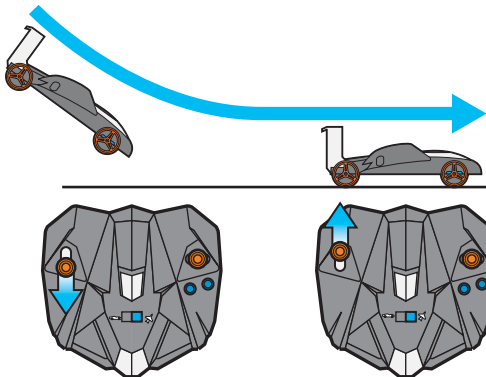

PERFORMING A SPIRAL STUNT

1. Fly the vehicle to a height of around 30 feet / 10 meters.
2. Let go of the throttle joystick and push the steering joystick all the way to the left (or right).
3. The vehicle will descend and spiral downward.
4. To recover from spiraling downward, let go of the steering joystick and push the throttle joystick forward.

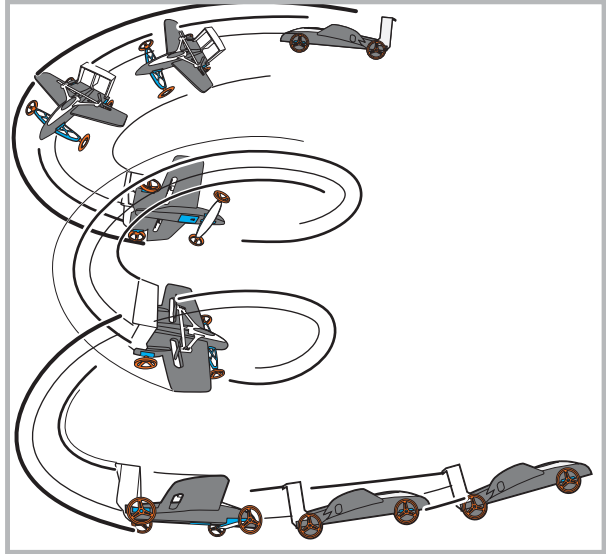
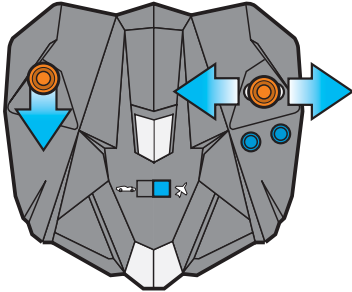

PERFORMANCE TIPS

- Launching into a gentle breeze will allow the vehicle to take off with the least amount of runway space.
- Make small, smooth and slow movements on the throttle and steering joysticks.
- Vehicle can be hand launched by holding it directly under the wings, then pushing the throttle joystick completely forward and gently throwing the vehicle ahead, parallel to the ground.

REPAIR & TROUBLESHOOTING

1. Use clear household tape to repair tears, creases or cracks. Use sparingly as added weight will affect performance.
2. Dirt or mud on the vehicle can affect its operation. Use a clean, dry cloth to remove any dirt immediately. If the vehicle gets wet, turn it off and allow it to dry completely overnight.
3. When the vehicle does not respond, slows down, or loses range, recharge the vehicle. If performance does not improve following a recharge, install fresh alkaline batteries in the transmitter.
4. Radio interference can affect your vehicle's performance. Interference can be caused by other R/C vehicles running on the same frequency, electrical wires, large buildings, WiFi or Bluetooth. If you experience interference, turn off your vehicle and transmitter and relocate to a different area.
5. When exposed to an electrostatic source, the toy may malfunction. Switch OFF both the vehicle and transmitter. Remove batteries from the transmitter, wait 30 seconds, re-insert batteries and switch ON again. This should reset your transmitter / vehicle and let you resume normal operation.

REPLACING THE PROPELLERS

Street Hawk™ comes with 2 replacement propellers - one for each side. If either of the vehicle's propellers break off or become damaged, replace them by following the steps below.

1. Use a coin (not included) to pry off the old propeller.

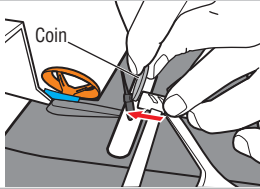

2. Select the required propeller. "L" is for left side. "R" is for right side.

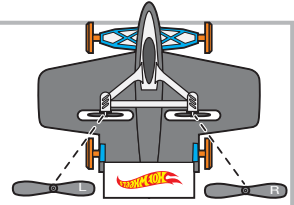

3. Align the pin from the motor with the hole in the propeller. Make sure the molded letter (L or R) on the propeller is facing the pin.

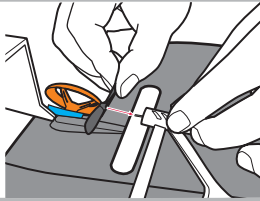

4. Use the coin to gently push the propeller onto the pin. The coin will prevent the pin from poking your finger.

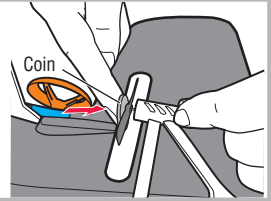

BATTERY SAFETY INFORMATION

In exceptional circumstances batteries may leak fluids that can cause a chemical burn injury or ruin your product. To avoid battery leakage:

- Non-rechargeable batteries are not to be recharged.
- Rechargeable batteries are to be removed from the product before being charged.
- Rechargeable batteries are only to be charged under adult supervision.
- Do not mix alkaline, standard (carbon-zinc), or rechargeable (nickel-cadmium) batteries.
- Do not mix old and new batteries.
- Only batteries of the same or equivalent type as recommended are to be used.
- Batteries are to be inserted with the correct polarity.
- Exhausted batteries are to be removed from the product.
- The supply terminals are not to be short-circuited.
- Dispose of battery(ies) safely.
- Do not dispose of this product in a fire. The batteries inside may explode or leak.

Battery Performance Note:

For best performance use alkaline batteries. Battery life may vary depending on battery brand.



Protect the environment by not disposing of this product with household waste (2002/96/EC). Check your local authority for recycling advice and facilities.

For additional help, visit www.HotWheels.com/StreetHawk