



Some features of this product only work with the Fisher-Price® Smart Connect™ app. Download the Fisher-Price® Smart Connect™ app to control this product from your smart device (not included). This app is available from the App Store<sup>SM</sup> or Google Play™.

Please keep this instruction sheet for future reference, as it contains important information.

Requires four D (LR20) **alkaline** batteries (not included) for operation. Adult assembly is required. Tool required: Phillips screwdriver (not included).

## Consumer Information



### WARNING

#### **Prevent Entanglement Injury**

- Keep mobile out of baby's reach.
- Remove mobile portion of product from crib or playpen when baby begins to push up on hands and knees.
- This product may not attach to all crib designs. Do not add additional strings or straps to attach to a crib or playpen.
- Use **ONLY** attached to a crib.

- Use as a mobile from birth to 5 months.
- The soother can be used from birth until 36 months.
- A mobile is intended for visual stimulation and not to be grasped by a child.

# Consumer Information

## Care

Wipe this toy with a clean, damp cloth. Do not immerse.

## Industry Canada (IC) Statement

This device complies with Industry Canada licence-exempt RSS standard(s). Operation is subject to the following two conditions: (1) this device may not cause interference, and (2) this device must accept any interference, including interference that may cause undesired operation of the device.

## Canada, avis d'Industry Canada (IC)

Le présent appareil est conforme aux CNR d'Industrie Canada applicables aux appareils radio exempts de licence. L'exploitation est autorisée aux deux conditions suivantes: (1) l'appareil ne doit pas produire de brouillage, et (2) l'utilisateur de l'appareil doit accepter tout brouillage radioélectrique subi, même si le brouillage est susceptible d'en compromettre le fonctionnement.

# Consumer Information



## CONSUMER ASSISTANCE

1-800-432-5437 (US & Canada)  
1300 135 312 (Australia)

### service.fisher-price.com

---

Fisher-Price, Inc., 636 Girard Avenue, East Aurora, NY 14052.  
Hearing-impaired consumers: 1-800-382-7470.

---

**Outside the United States:**

Canada: Mattel Canada Inc., 6155 Freemont Blvd.,  
Mississauga, Ontario L5R 3W2; [www.service.mattel.com](http://www.service.mattel.com).

Great Britain: Mattel UK Ltd, Vanwall Business Park,  
Maidenhead SL6 4UB. Helpline: 01628 500303.  
[www.service.mattel.com/uk](http://www.service.mattel.com/uk)

Mattel Europa B.V., Gondel 1, 1186 MJ Amstelveen, Nederland.

Australia: Mattel Australia Pty. Ltd., 658 Church Street,  
Locked Bag #870, Richmond, Victoria 3121 Australia.

New Zealand: 16-18 William Pickering Drive,  
Albany 1331, Auckland.

## CAN ICES-3 (B)/NMB-3 (B)

Operation is subject to the following two conditions: (1) this device may not cause interference, and (2) this device must accept any interference, including interference that may cause undesired operation of the device.

L'utilisation de ce dispositif est autorisée seulement aux conditions suivantes : (1) il ne doit pas produire de brouillage et (2) il doit pouvoir tolérer tout brouillage radioélectrique reçu, même si ce brouillage est susceptible de compromettre son fonctionnement.

## FCC STATEMENT (UNITED STATES ONLY)

This equipment has been tested and found to comply with the limits for a Class B digital device, pursuant to Part 15 of the FCC rules. These limits are designed to provide reasonable protection against harmful interference in a residential installation. This equipment generates uses and can radiate radio frequency energy and, if not installed and used in accordance with the instructions, may cause harmful interference to radio communications. However, there is no guarantee that interference will not occur in a particular installation. If this equipment does cause harmful interference to radio or television reception, which can be determined by turning the equipment off and on, the user is encouraged to try to correct the interference by one or more of the following measures:

- Reorient or relocate the receiving antenna.
- Increase the separation between the equipment and receiver.
- Consult the dealer or an experienced radio/TV technician for help.

NOTE: Changes or modifications not expressly approved by the manufacturer responsible for compliance could void the user's authority to operate the equipment.

This device complies with Part 15 of the FCC Rules. Operation is subject to the following two conditions: (1) This device may not cause harmful interference, and (2) this device must accept any interference received, including interference that may cause undesired operation.



Apple, iPhone, iPad and iPod touch are trademarks of Apple Inc., registered in the U.S. and other Countries. App Store is a service mark of Apple Inc.

Android and Google Play are trademarks of Google Inc.

©2015 Mattel. All Rights Reserved. ® and ™ designate U.S. trademarks of Mattel, except as noted.

# Battery Installation

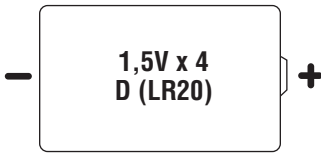

For longer life, use **alkaline** batteries.

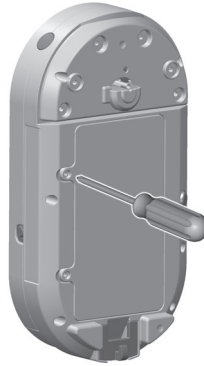

- 
- Loosen the screws in the battery compartment door and remove the door.
  - Insert four D (LR20) **alkaline** batteries.
  - Replace the battery compartment door and tighten the screws.
  - If this toy begins to operate erratically, you may need to reset the electronics. Slide the power switch off and back on.
  - When sounds/lights/projection become faint or stop, it's time for an adult to change the batteries.
  -  Protect the environment by not disposing of this product with household waste (2012/19/EU). Check your local authority for recycling advice and facilities.

## Battery Safety Information

In exceptional circumstances, batteries may leak fluids that can cause a chemical burn injury or ruin your product. To avoid battery leakage:

- Do not mix old and new batteries or batteries of different types: alkaline, standard (carbon-zinc) or rechargeable (nickel-cadmium).
- Insert batteries as indicated inside the battery compartment.
- Remove batteries during long periods of non-use. Always remove exhausted batteries from the product. Dispose of batteries safely. Do not dispose of this product in a fire. The batteries inside may explode or leak.
- Never short-circuit the battery terminals.
- Use only batteries of the same or equivalent type, as recommended.
- Do not charge non-rechargeable batteries.
- Remove rechargeable batteries from the product before charging.
- If removable, rechargeable batteries are used, they are only to be charged under adult supervision.

## Assembled Parts

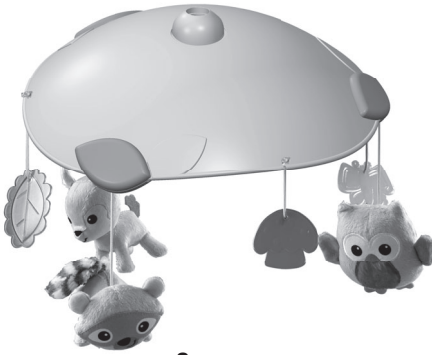

Canopy



Arm



Crib Adaptor



Soother

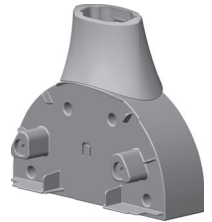

Mobile Adaptor

**Note:** All of the screws used to assemble this toy are attached to the product. Follow these instructions carefully to fully secure the screws. Tighten and loosen all screws with a Phillips screwdriver. Do not over-tighten the screws.

# Assembly

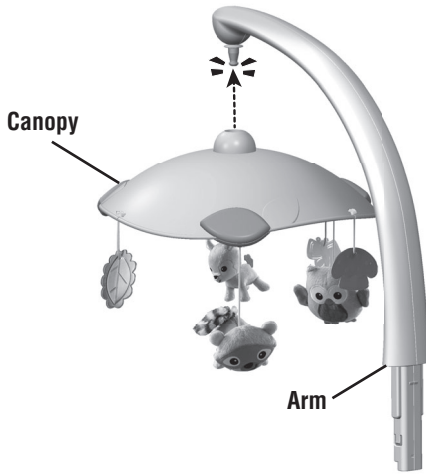

1

- Fit the canopy onto the peg on the end of the arm. Push to “**snap**” in place.



2

- Fit the arm into the socket in the mobile adaptor. Push to “**snap**” in place.

# Assembly



3

- Fit the mobile assembly onto the back of the soother. Tighten all four screws.

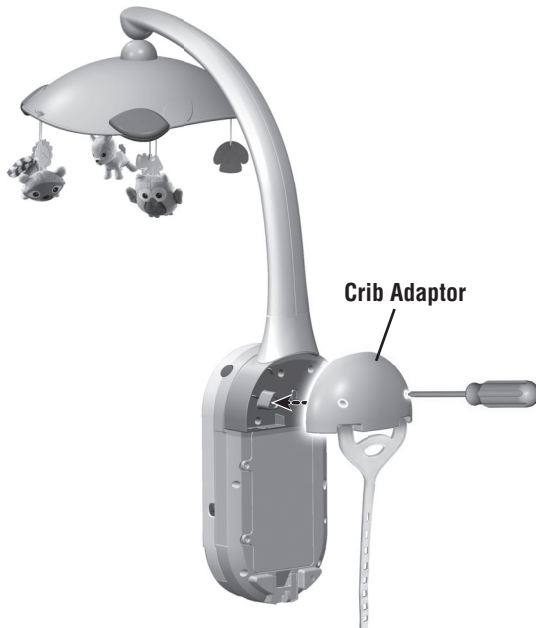

4

- Fit the crib adaptor onto the mobile adaptor. Tighten the two screws.



# Crib Attachment

**IMPORTANT!** Always attach all provided fasteners (strings, straps, clamps, etc.) tightly to a crib or playpen according to the instructions. Check frequently.

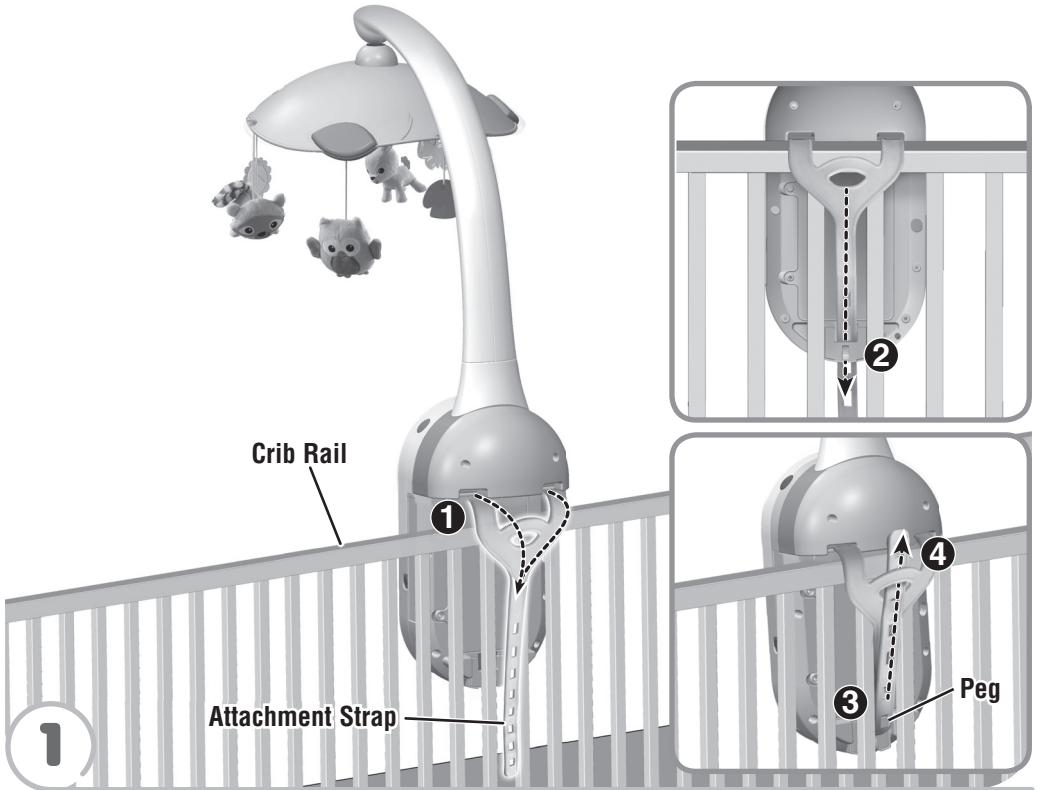

- Position the toy inside the crib. Make sure the attachment strap is on the outside of the crib **1**.
- Slide the end of the attachment strap down through the slot on the back of the toy **2**.
- Pull the end of the attachment strap up and fasten to the peg on the back of the toy **3**.

**Note:** This toy should be snug against the crib rail and spindles. Use the strap slot that provides the tightest fit.

- If you have excess strap, slide the free end of the attachment strap up through the opening near the top of the attachment strap **4**.

## Crib Attachment

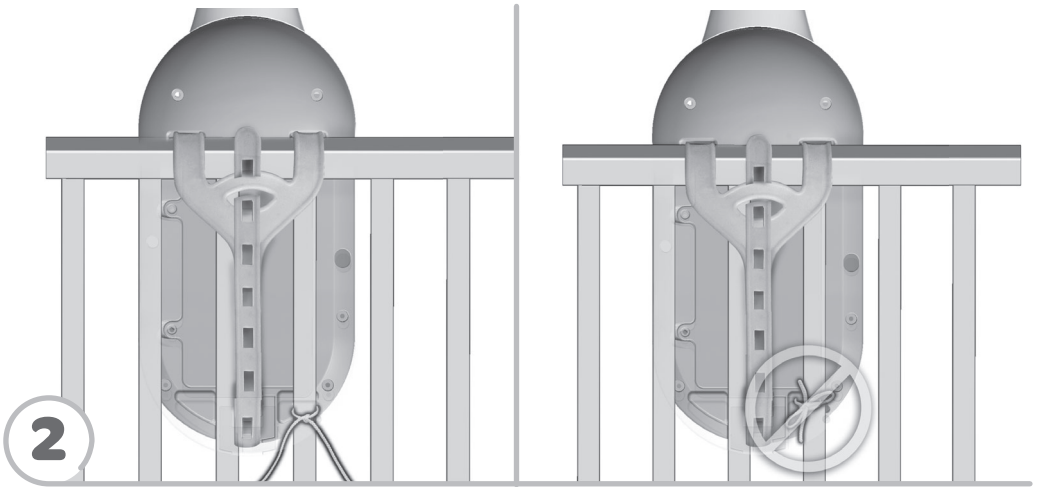

- Tie the toy's strings to a crib spindle.

**Note:** It is better to tie the strings in a knot than a bow, since a bow may be easily untied.

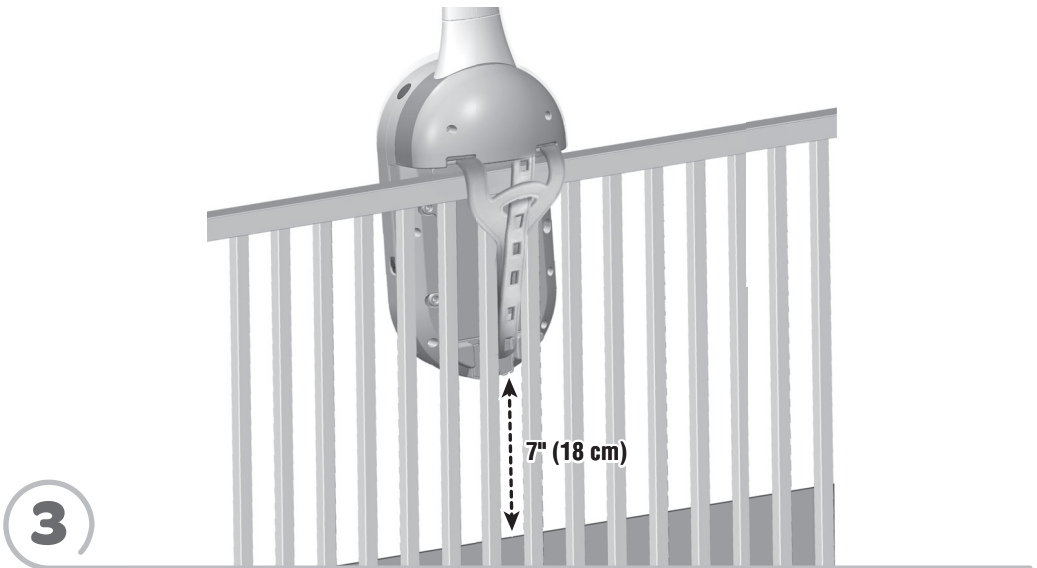

- If the distance between the base and the mattress is less than 7 inches (18 cm), lower the crib mattress.

# Use

## — + Volume Buttons

Press to adjust the volume level.

## ☀ Light Button

Press to turn the check light ON or OFF.

**Hint:** The check light times out after approximately one minute.



## Mobile/Projector Button

Press to turn on the mobile and projector. Press the button again to turn on the mobile only. Press the button again to turn off the mobile.

## Music/Sound Selection Buttons

- ☎ Press to turn on white noise. Press again to turn off white noise.
- 🌿 Press to turn on sound effects. Press again to turn off sound effects.
- 🎵 Press to turn on music. Press again to turn off music.

**Hint:** Press the music or sound effect button a third time to play a different song or sound effect.

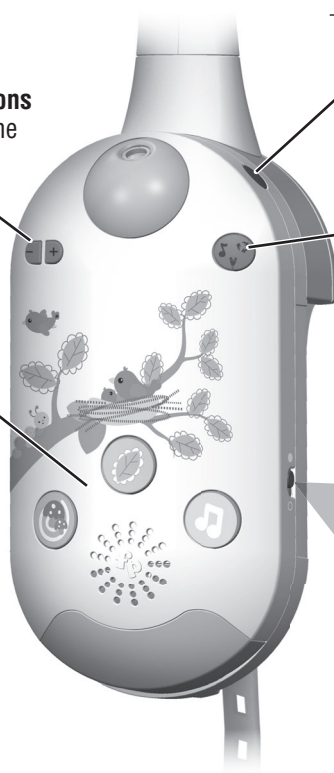

## Power Switch

Slide the power switch ● ON or ○ OFF.

## Convert to Soother

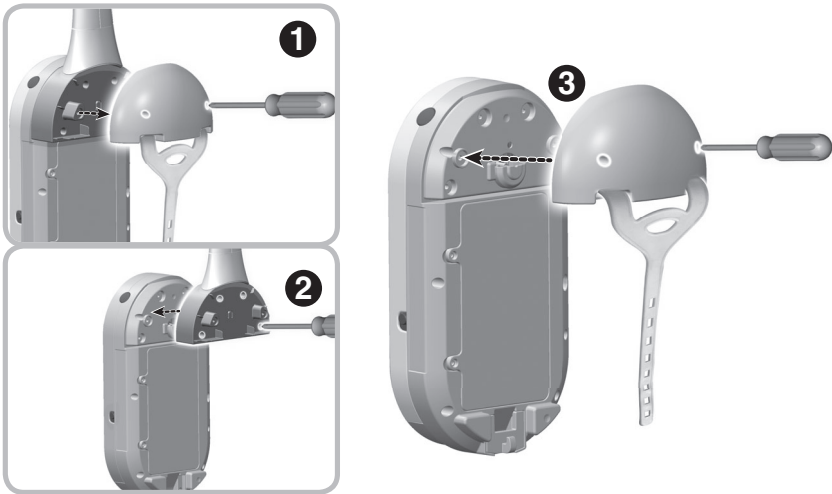

- Remove the mobile from the crib.
- Loosen the screws in the crib adaptor and remove it **1**.
- Loosen the screws in the mobile assembly and remove it **2**. Store the mobile in a safe place for future use.
- Fit the crib adaptor onto the back of the soother and tighten the screws **3**.
- Attach the soother to the crib. Please refer to the **Crib Attachment** section for instructions.

# Pairing Your Device

Before using the Smart Connect™ app for the first time, you will need to pair your device with the mobile.

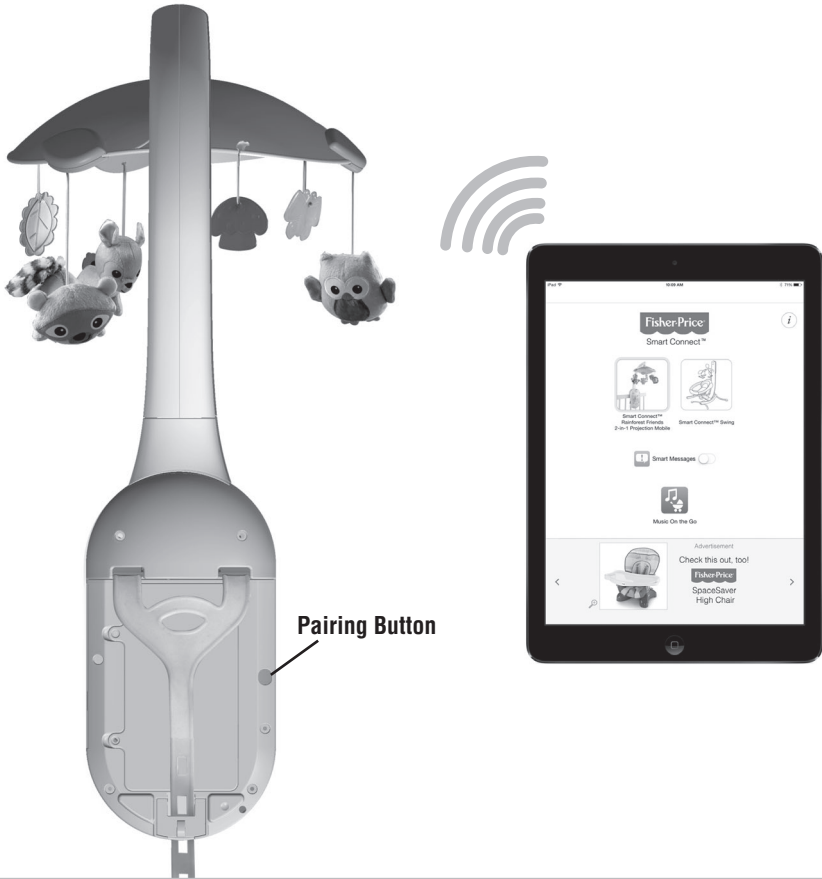

- Open the Smart Connect™ app on your device. Be sure your device is within approximately 6 feet (1,8 meters) of the mobile to pair.
  - Next, slide the mobile power switch ON.
  - Then, press the pairing button on the back of the mobile. The mobile will stay in the pairing mode for approximately 30 seconds.
- Hint:** *If you cannot pair your device with the mobile, try moving the device closer to the mobile.*
- The mobile icon will be highlighted in green in the app when the mobile is connected to your device. This indicates that you can use your device to control the mobile.

# Smart Connect™ App

App features and decorations shown in photographs and illustrations may vary.

Press the mobile icon to open the mobile controls.



Press the switch icon to turn the Smart Messages ON or OFF. When Smart Messages are enabled you will receive pop-up notifications on your device to tell you the status of your mobile.

Press the Music On the Go icon to play songs from your device.

Press the back icon to return to the home screen.

Press the play/pause icon to start or stop music.

Press the forward or reverse icons to change the song.

Press the playlist icon to create a custom playlist from songs on your device.

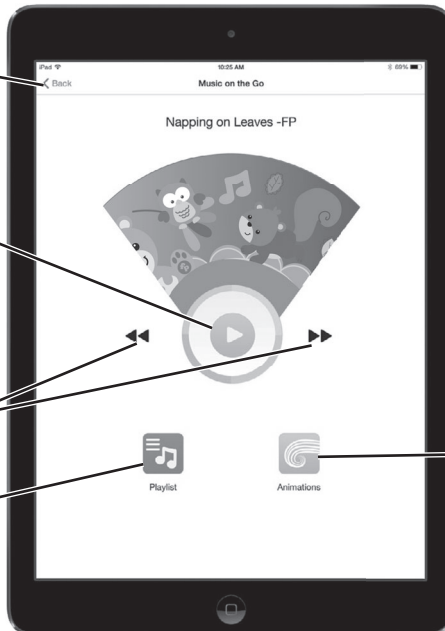

Press the animation icon to choose a display image for your device.

# Smart Connect™ App

View your device status here:  
**You're Connecting, You're Connected, You're Not Connected or Your mobile is out of range, turned off or asleep.**

Press to connect or disconnect your device from the mobile.

Press to customize mobile name.

Press to choose how long the mobile will stay on.

Press to turn the check light ON. Press the icon again to turn the check light OFF.

Press to turn the mobile ON. Press the icon again to turn the mobile OFF.

Press to turn the mobile and projector ON. Press the icon again to turn the mobile and projector OFF.

Press to choose how long music/sounds will play.

Press to turn the music/sounds ON. Press the icon again to turn music/sounds OFF. Press the music or nature sounds icon a third time to play a different song/sound effect.

Press to adjust volume level.

*Hint: Music/sound effects must be ON to use this feature.*

Press to turn the Sound Sensor Smart Messages ON. Press the icon again to turn OFF.

**Hints:** *This feature can only be used when music/sounds and mobile/projector are turned OFF. The sound sensor will display a pop-up message if a sound is detected in baby's room.*

Slide to adjust the sensitivity level of the sound sensor.

This icon displays the battery life of your mobile. When the battery icon turns red or is at 0%, it's time to replace the batteries.

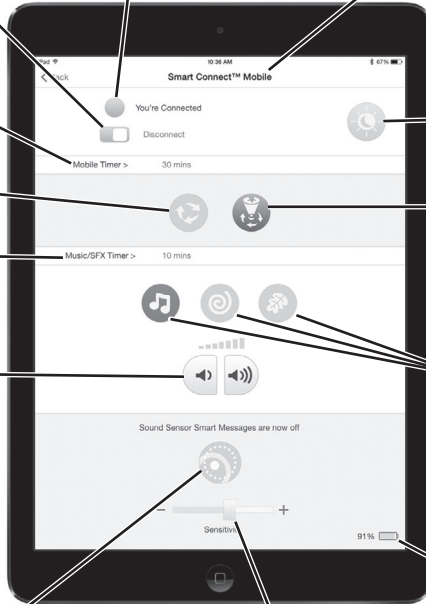

# Smart Connect™ App Compatibility

The Fisher-Price® Smart Connect™ app is compatible with the devices listed in the table.

APPLE®	ANDROID™
<ul style="list-style-type: none"><li>• iPhone® 4s or newer</li><li>• iPad® (mini with Retina display, mini, Air, 4th &amp; 3rd gen) or newer</li><li>• iPod touch® (5th gen)</li></ul>	<ul style="list-style-type: none"><li>• Google Nexus 6, Nexus 5, Nexus 4</li><li>• Google Nexus 7 (2013), Nexus 10</li><li>• HTC One, One Max</li><li>• Motorola Droid (RAZR, Ultra, Maxx &amp; Mini)</li><li>• Motorola Moto G, X</li><li>• Samsung Galaxy S3 or newer</li><li>• Samsung Galaxy Tab 4, Pro, S or newer, Galaxy Note 3, Galaxy Note 8, 10.1, Pro 12.2, or newer, Galaxy Mega</li><li>• Sony Xperia (SP, Z, ZR, ZL, Z1, Z Ultra HSPA+)</li><li>• Sony Xperia Tablet Z</li><li>• LG G4</li></ul>

As technology changes, this app may become compatible with additional devices. Visit [fisher-price.com/SmartConnect](http://fisher-price.com/SmartConnect) for an up-to-date, complete list of compatible devices.