

 American Girl[®]

Grace's Home



Turn over for
Grace's Slumber Party
and Patisserie storybook!



MEGA[®]
BLOKS



Meet Grace!

Girl of the Year® Grace Thomas is an ideas girl. Whether she's inventing a new recipe or brainstorming ways to build a business, Grace is always dreaming up the next big thing.



She makes baking her business.

Grace has grown up around her grandparents' bakery. When she visited her aunt and uncle in Paris, France last summer, she helped out in their *patisserie*—a bakery that specializes in pastries and desserts. Now Grace is happy to be home and is ready to have fun with her friends Maddie and Ella.

In the kitchen, Grace bakes up some sweet surprises for the girls. When Maddie and Ella come over, they try out even more creative concoctions.

“We make a good team,” says Grace. “Hey, we’ve always wanted to start a business together,” she says. “Maybe we should try.”

They cook up ideas for adventure.

Maddie and Ella are as excited as Grace is about working together. They brainstorm business ideas as they play with the puppy, Bonbon, in Grace's bedroom. What will they come up with?



Grace and her friends are full of creative ideas.

Grace and her friends Maddie and Ella have a good time whether they're baking together, playing with Bonbon the puppy, or having a sleepover. They also have a great idea—they want to start their own baking business. It's a big job, but they're pretty sure they can do it. Read more about Grace in her books from American Girl.



IT'S TIME TO BUILD YOUR STORY



The journey begins when you open the box. Find everything you need to build your story, and get ready to start building!



Remove the instructions and take all the bags of pieces out of the box—you're almost ready to start building. Make sure you have your instructions handy!



Let's get organized! Take all the pieces out of the bags and lay them out where you can see them. Be careful not to lose any.



Pull the tab to take your American Girl mini figures out of the window. Now it's time to build your story!

YOUR BUILDABLE FIGURE

Did you know you can personalize your American Girl mini figures?

Collect them all, then mix and match pieces from each to customize them.

Use the different parts and accessories to change their look and style.

You can even create totally new characters that look like you and your friends!

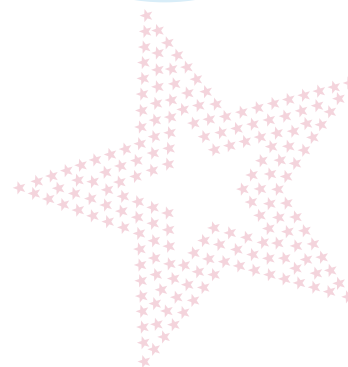



Let's get started by building the living room!



1

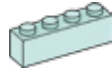

2x



2x

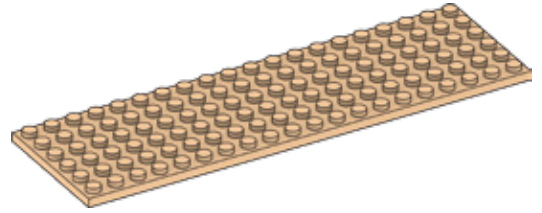

1x

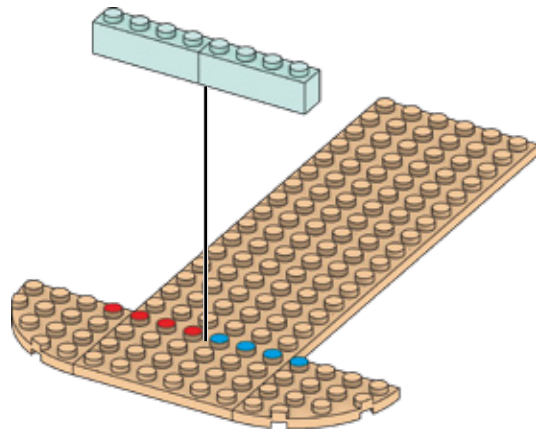

2



2x

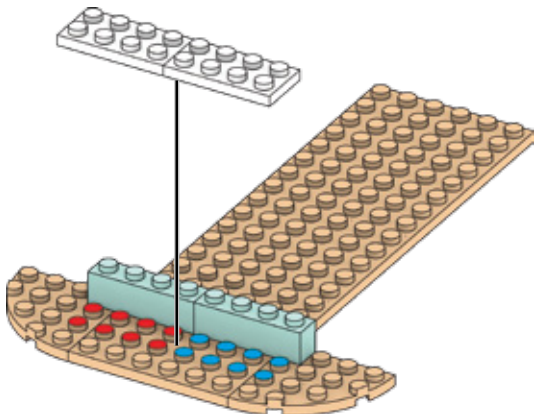

3



2x



1x

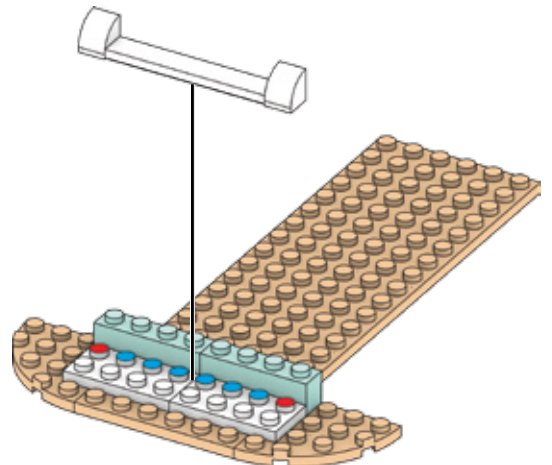



4



2x



2x

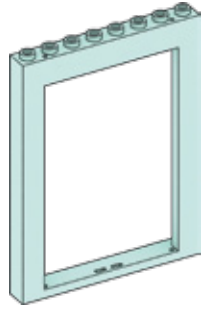

1x

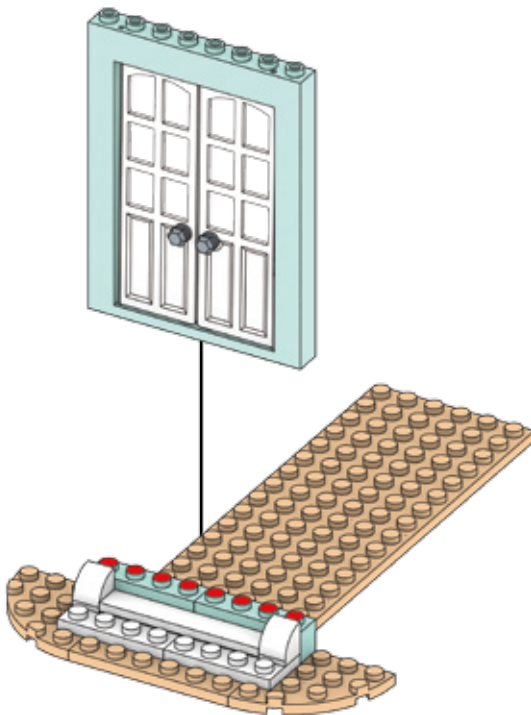
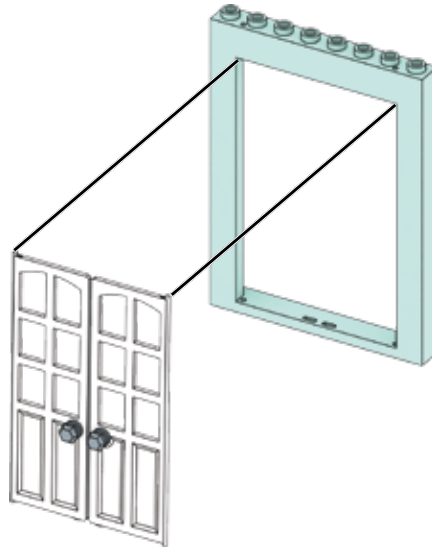
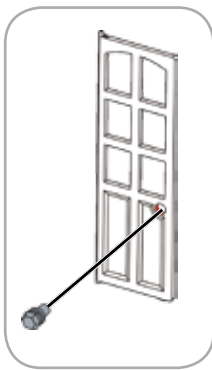

1

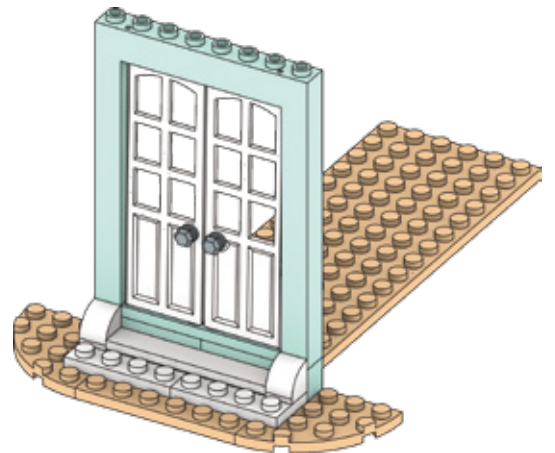

2



5

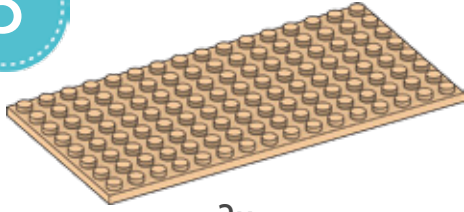

2x

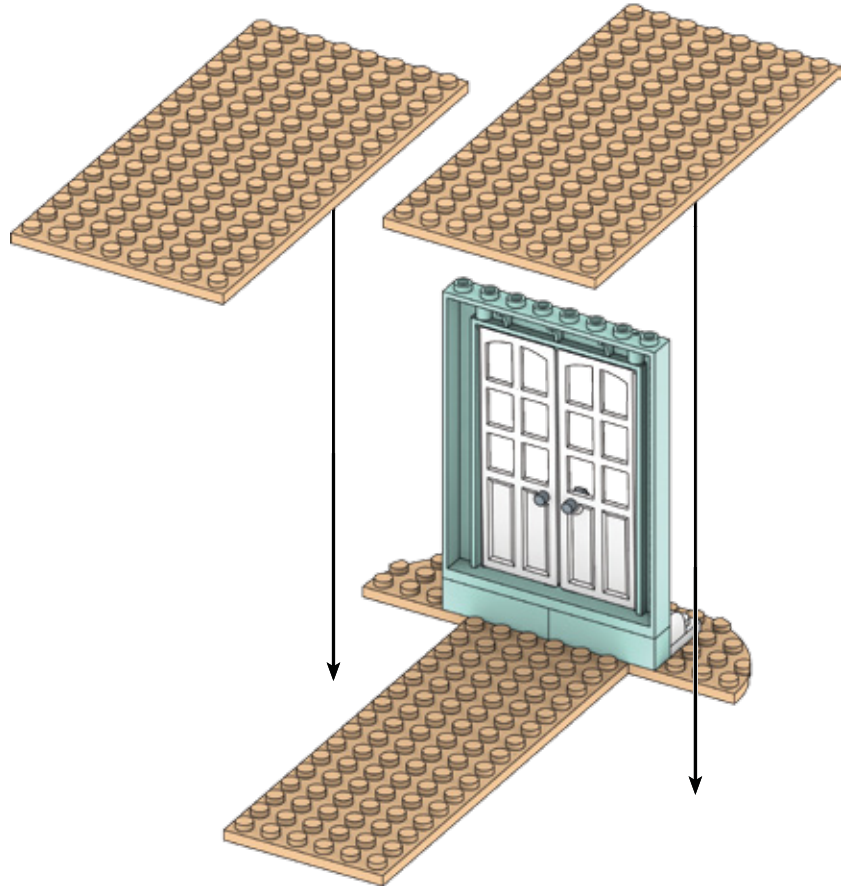

6



2x

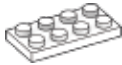

2x

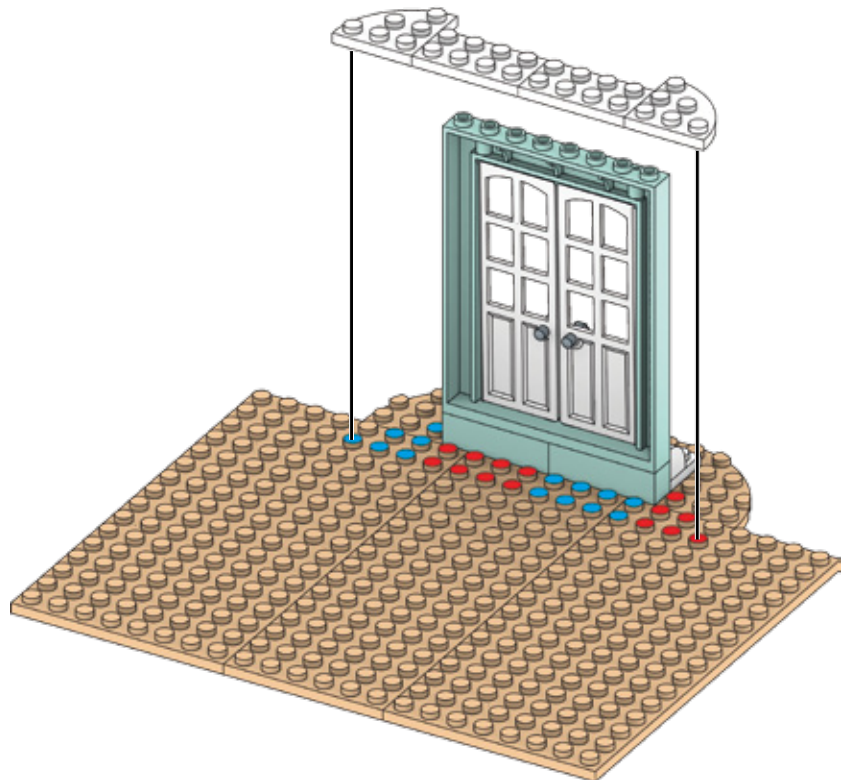



7



1x



1x



1x

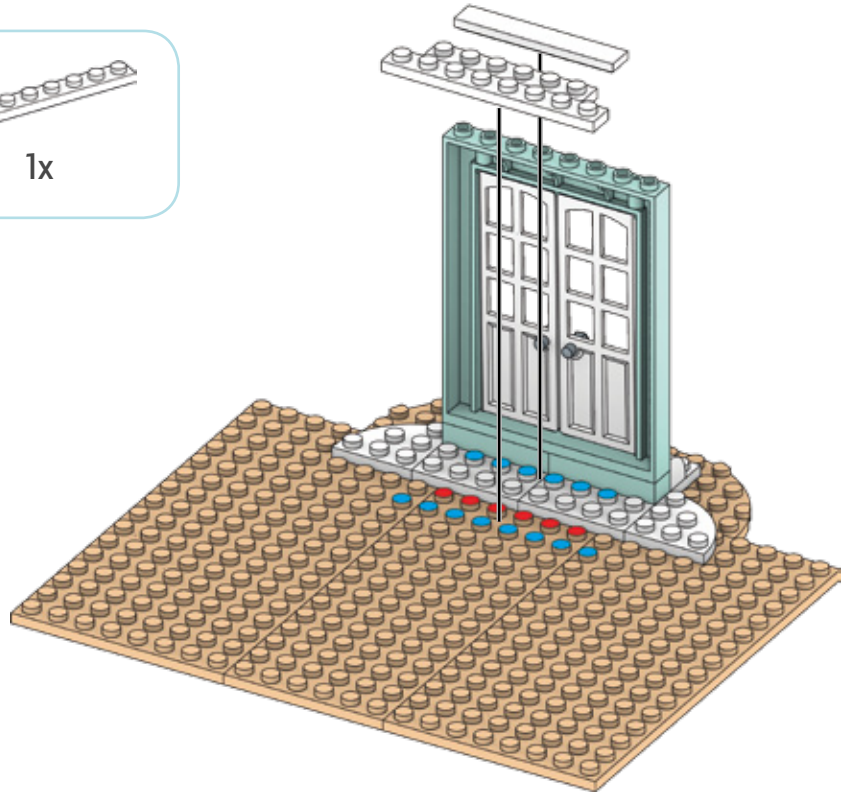

8



2x



7x



1



2

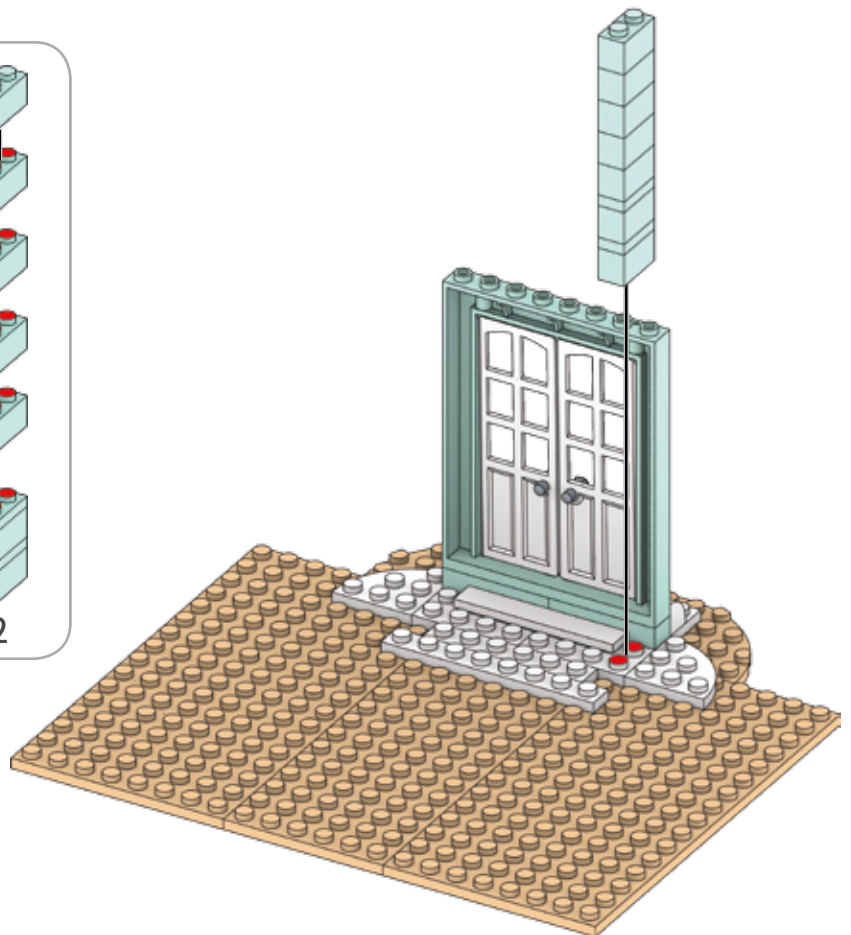



9



2x

7x



1



2

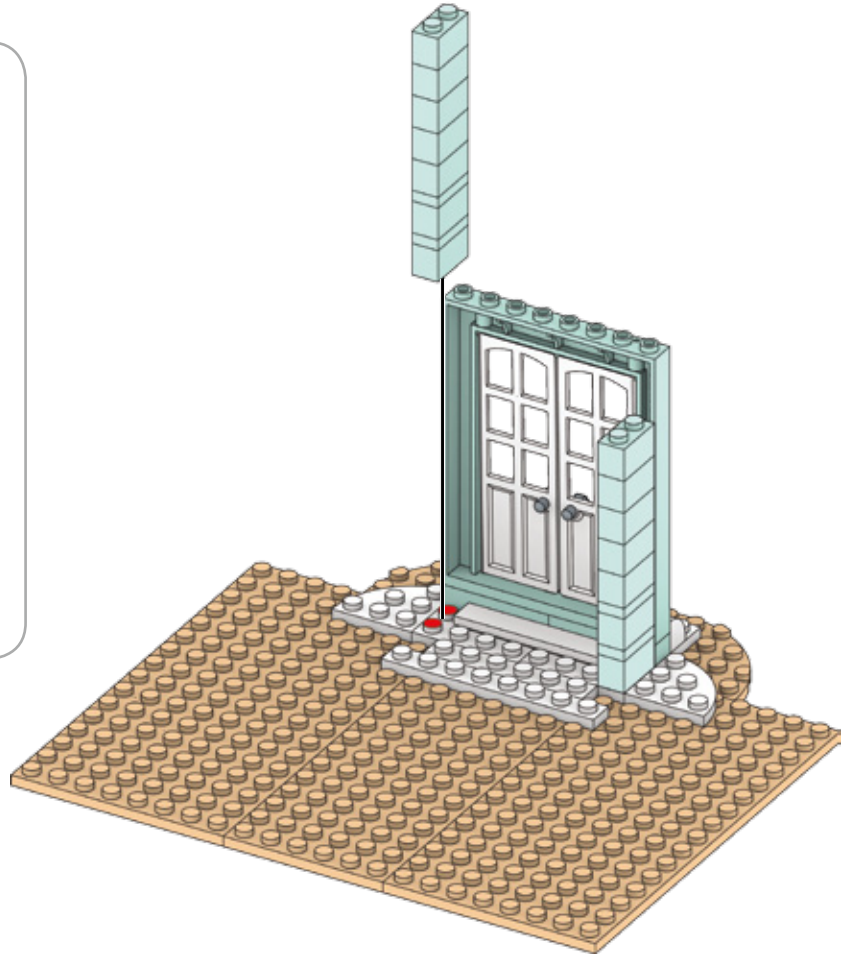

10



16x

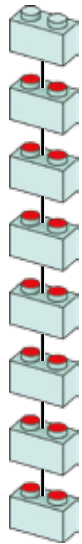

x2

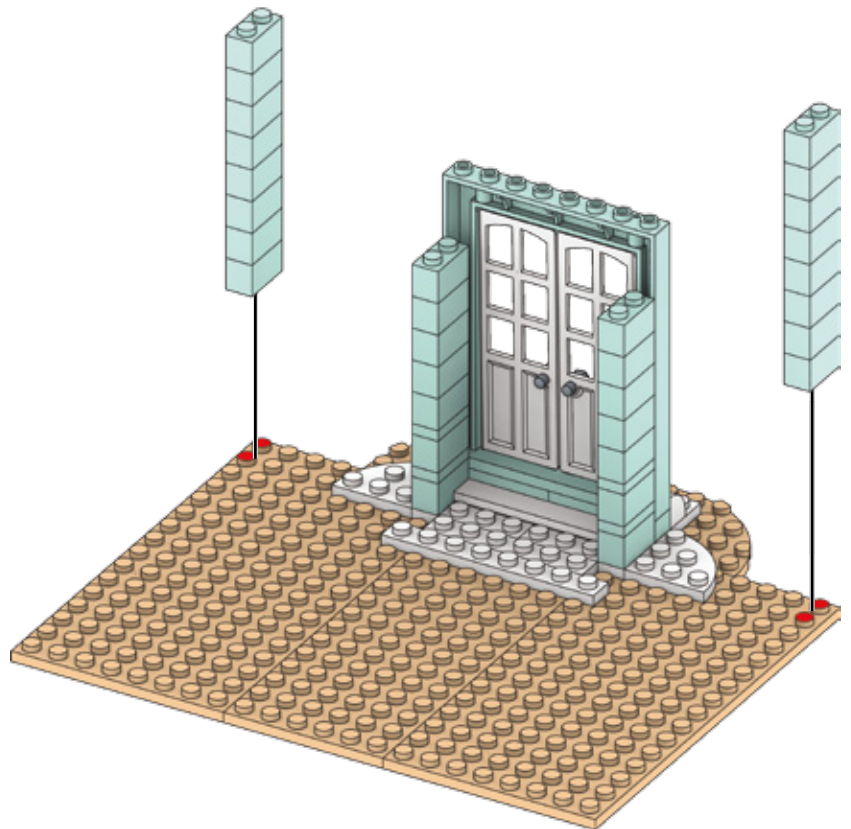



11

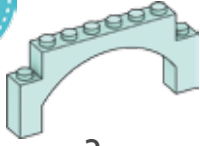

2x

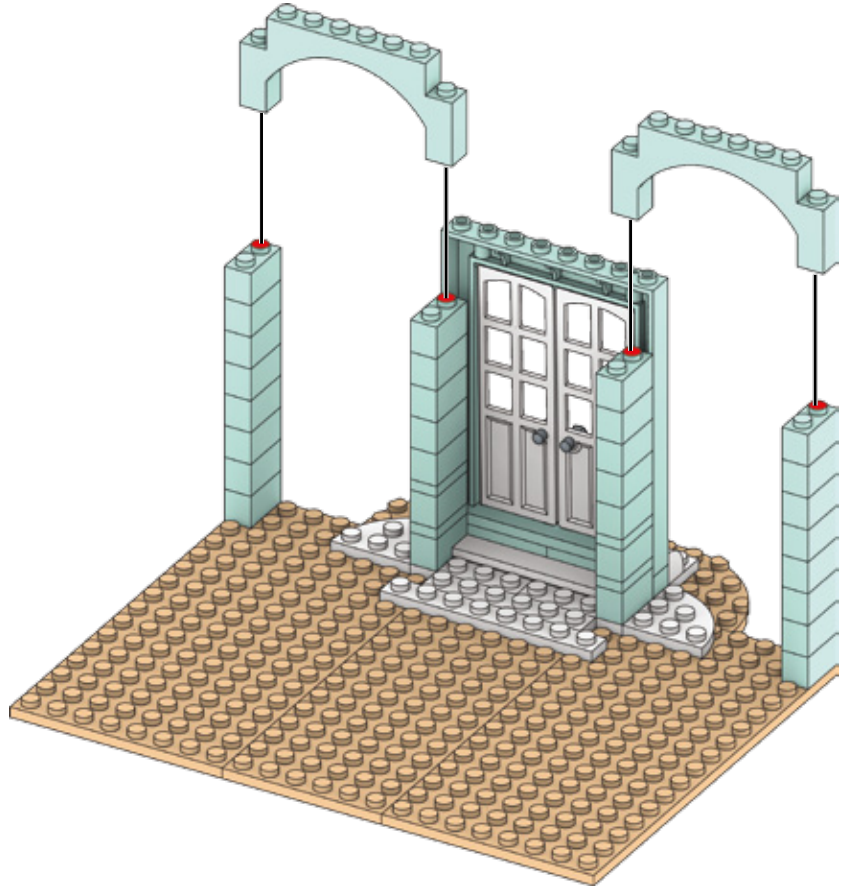

12



2x



2x

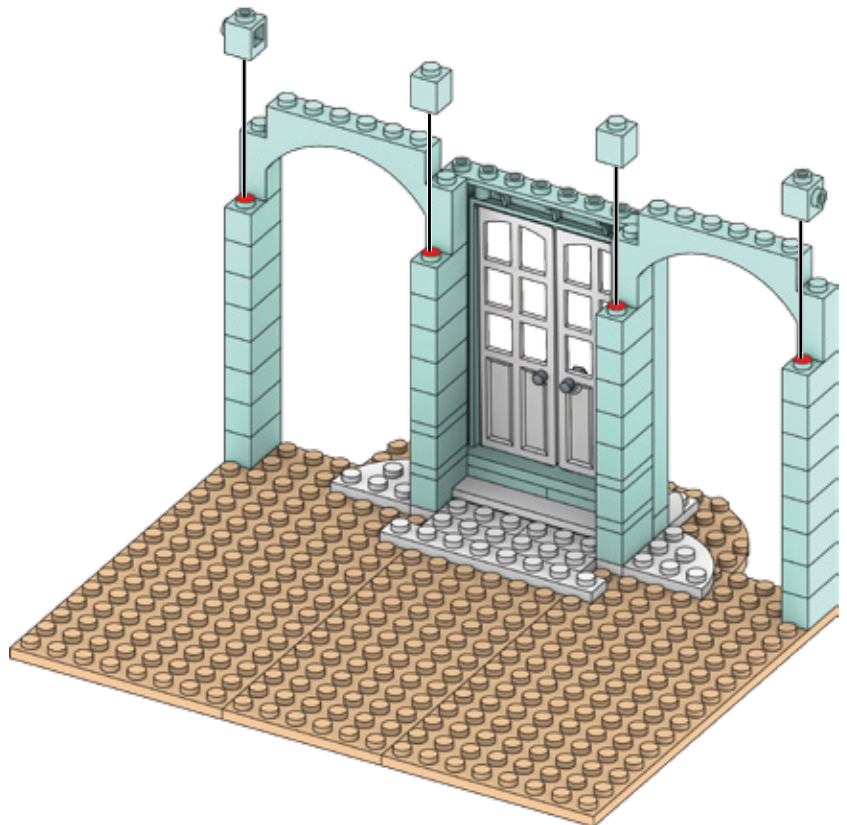



13

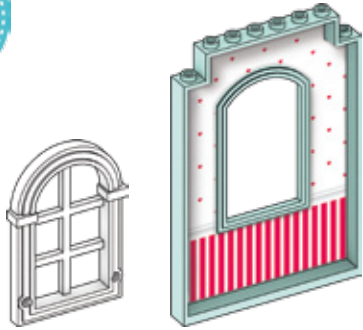

2x

2x

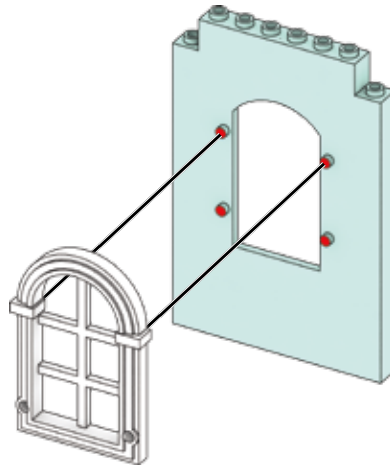

1



2

x2

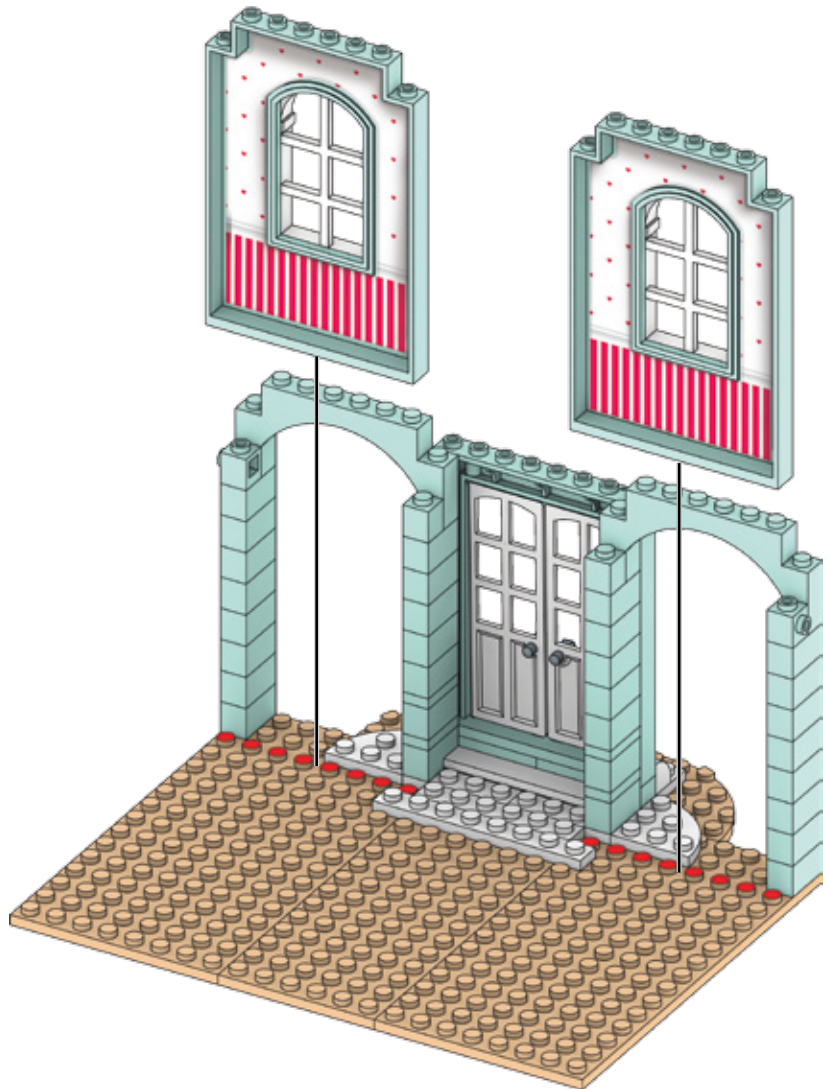



14

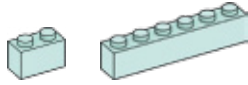

2x

2x

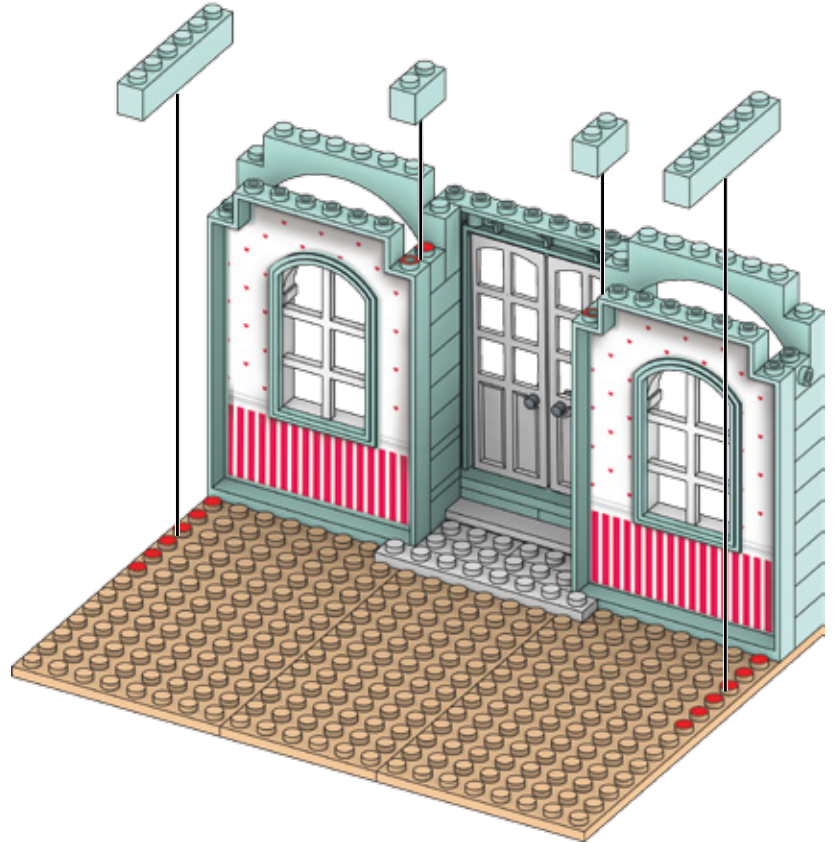

15



4x

2x

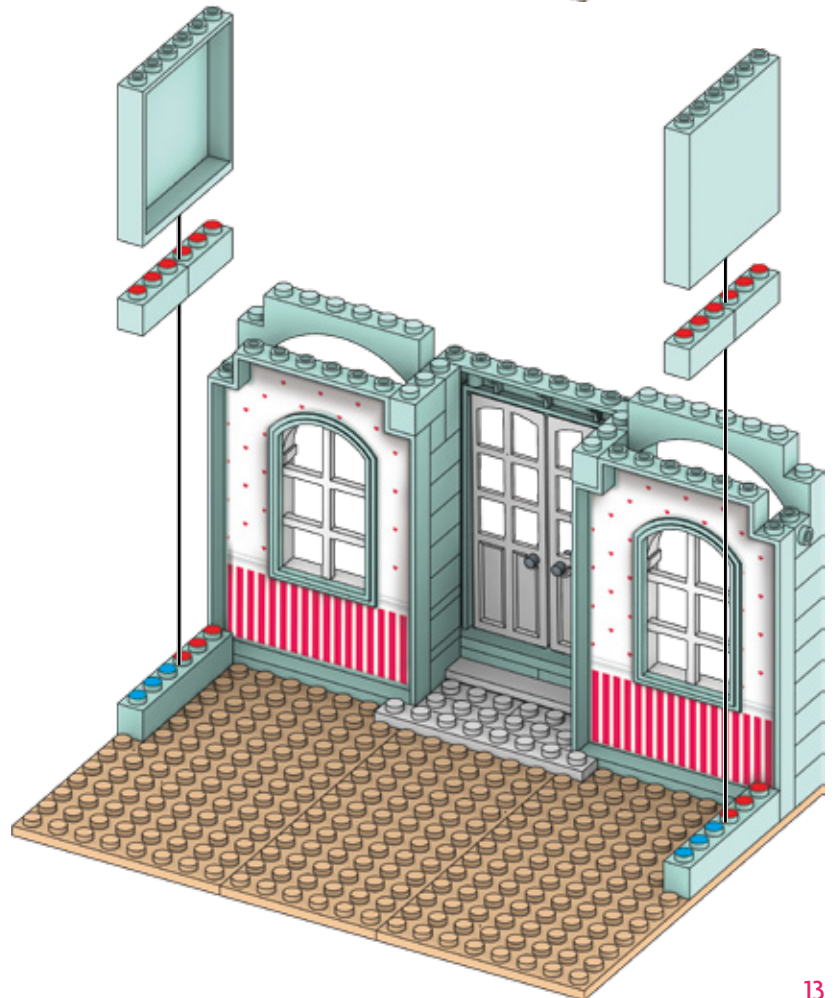



16



4x



4x

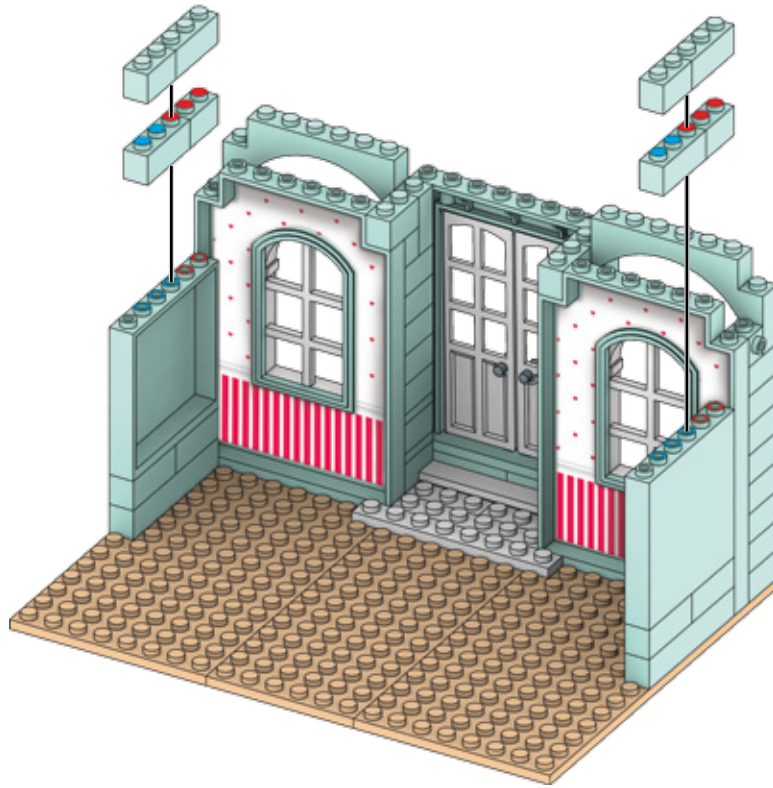

Did You Know?

The base you have built is used for both *Grace's Home* and *Grace's Slumber Party*.



To continue building *Grace's Home*, move on to Step 17.

or



If you'd like to change stories and build *Grace's Slumber Party*, turn the storybook over and turn to page 15.



17

Furniture Guide
page 4
E

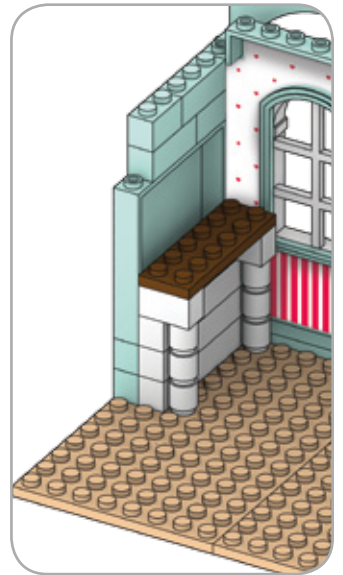
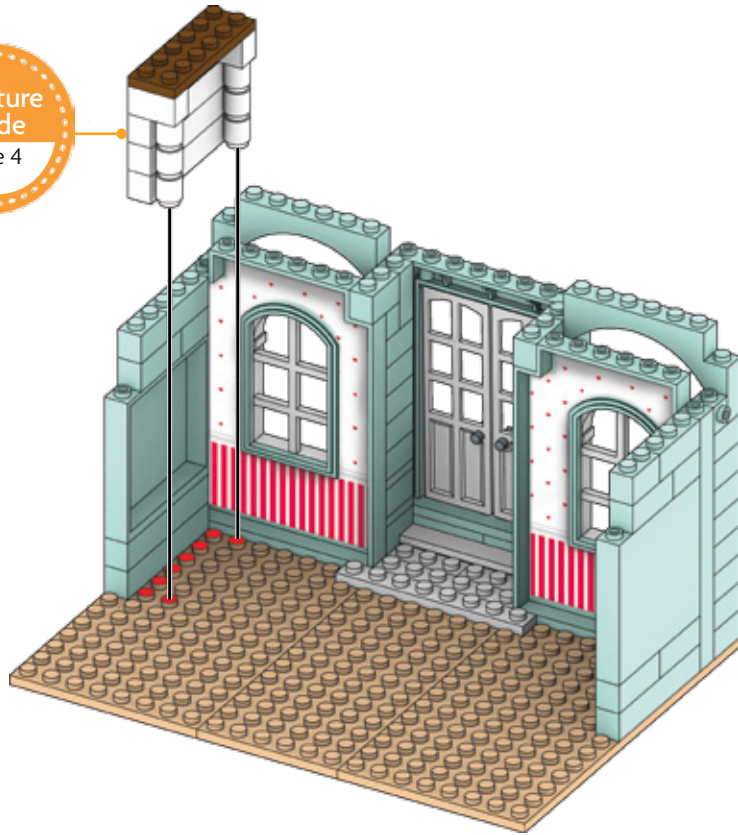

18

- 2x
- 2x
- 1x
- 2x

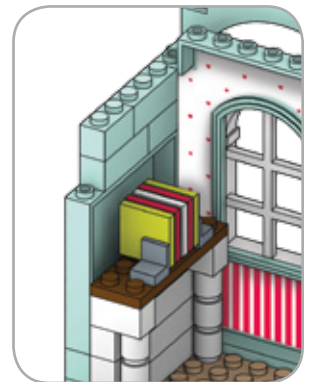
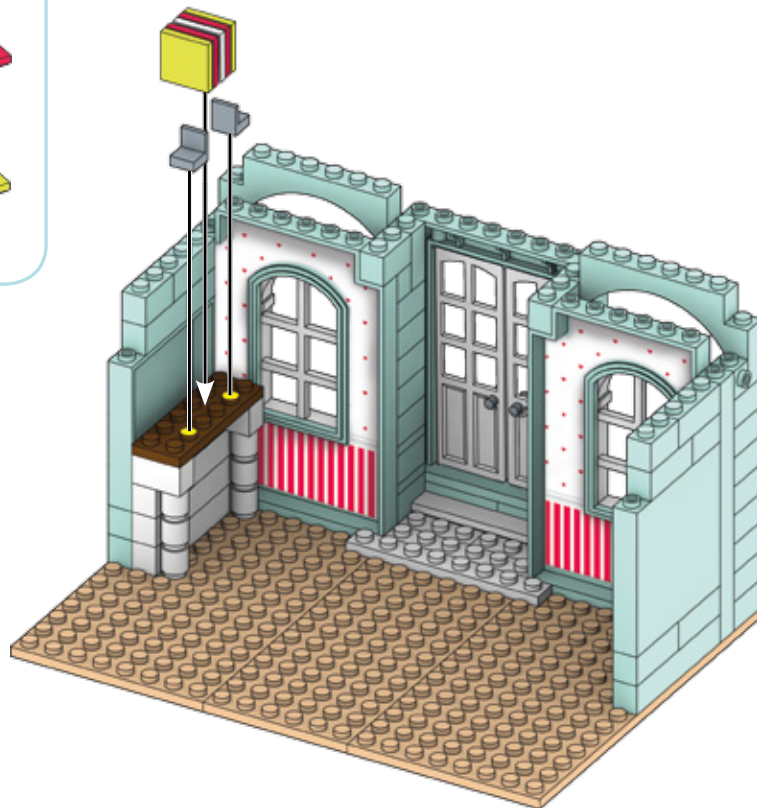



19



1X

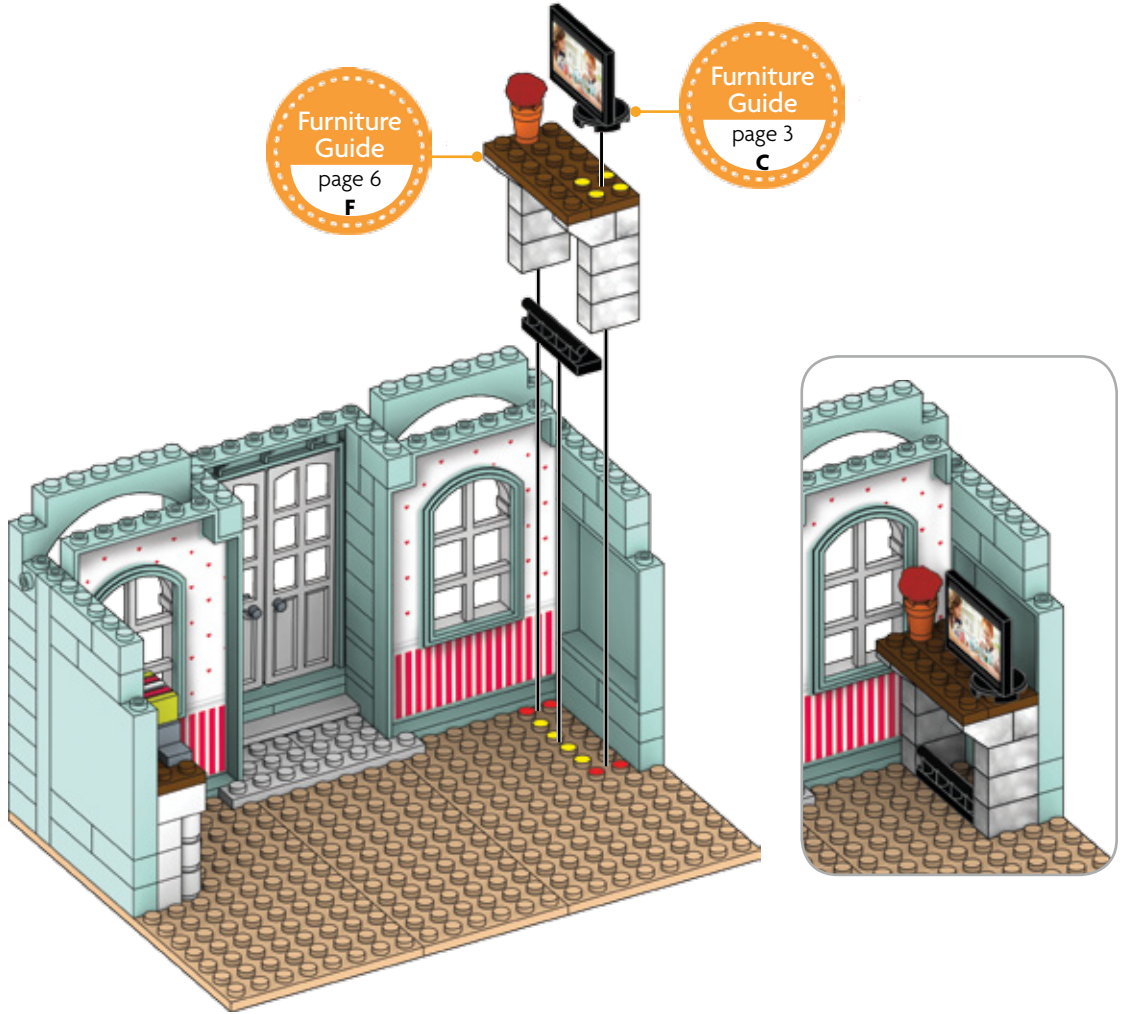

20



2x



2x

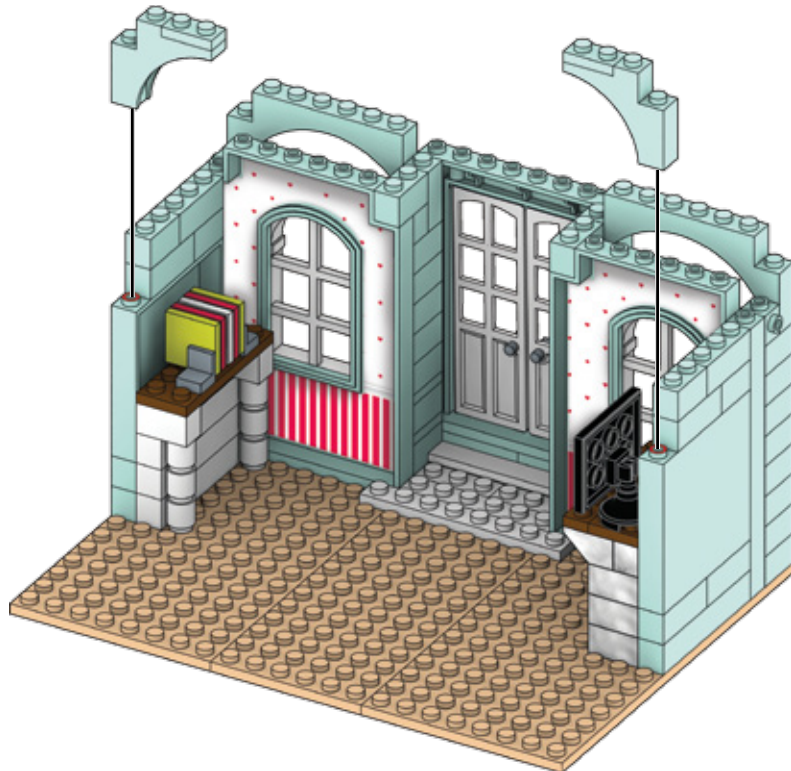
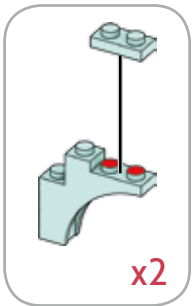



21

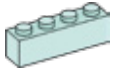

4x

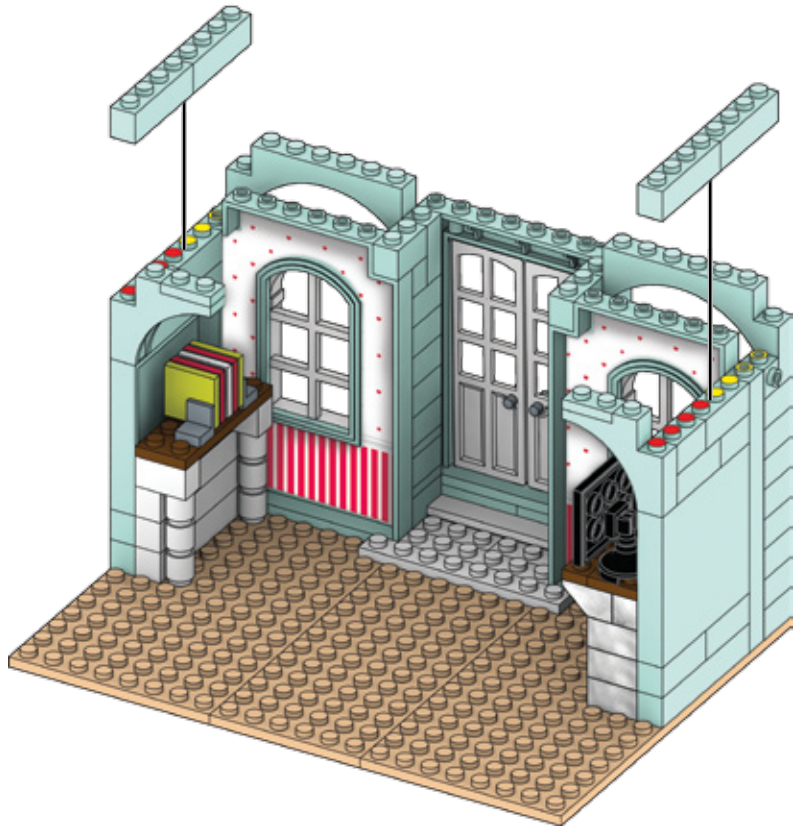

22

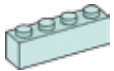

6x

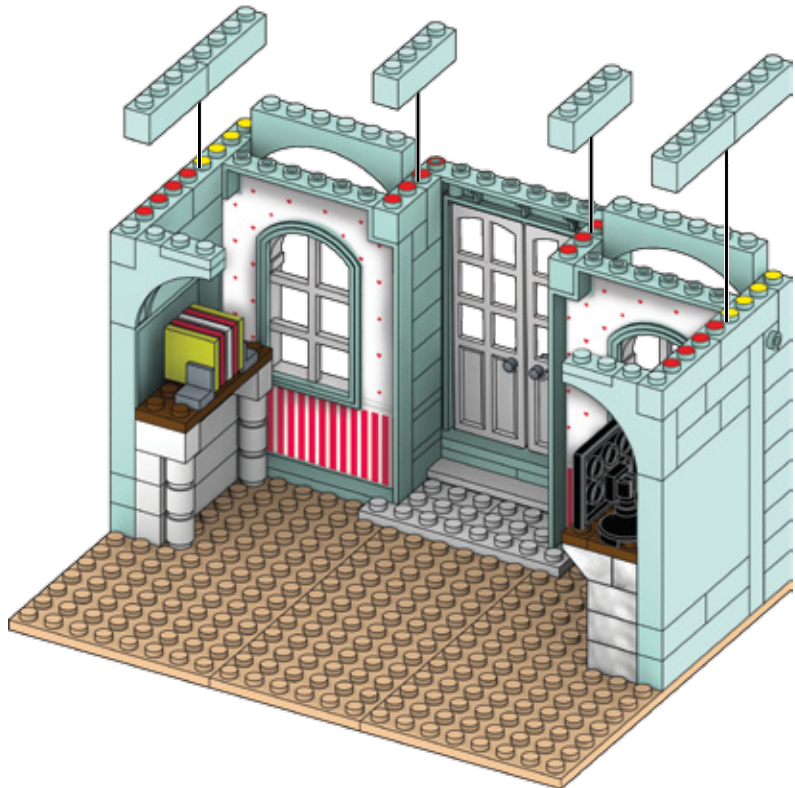



23

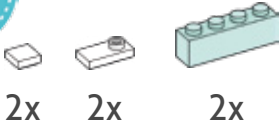

2x 2x 2x

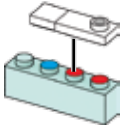

x2

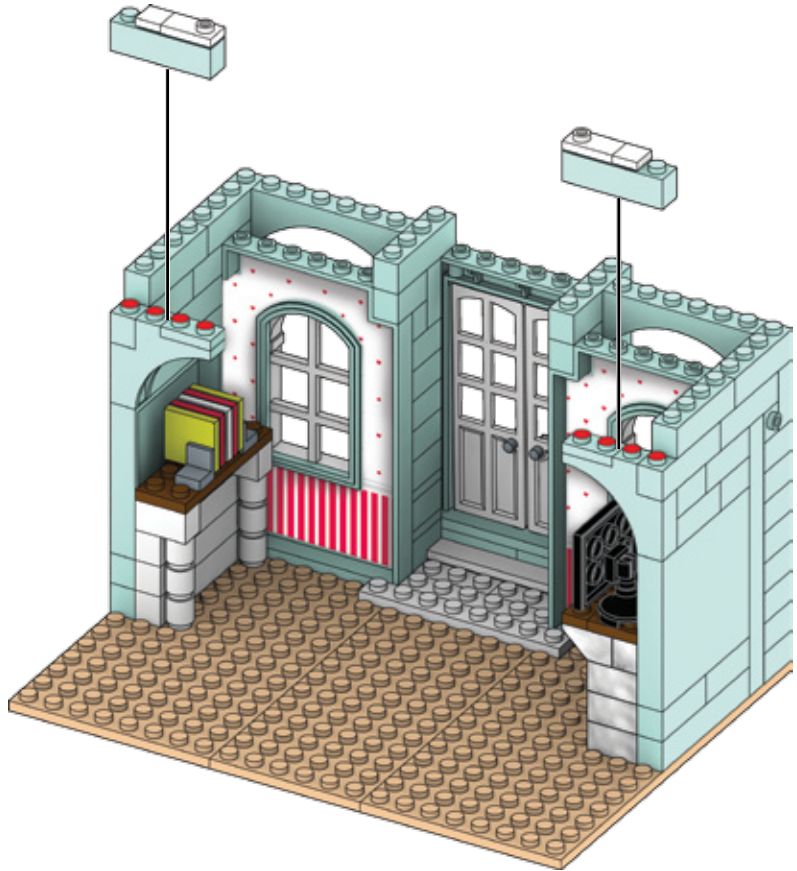

24



2x 3x

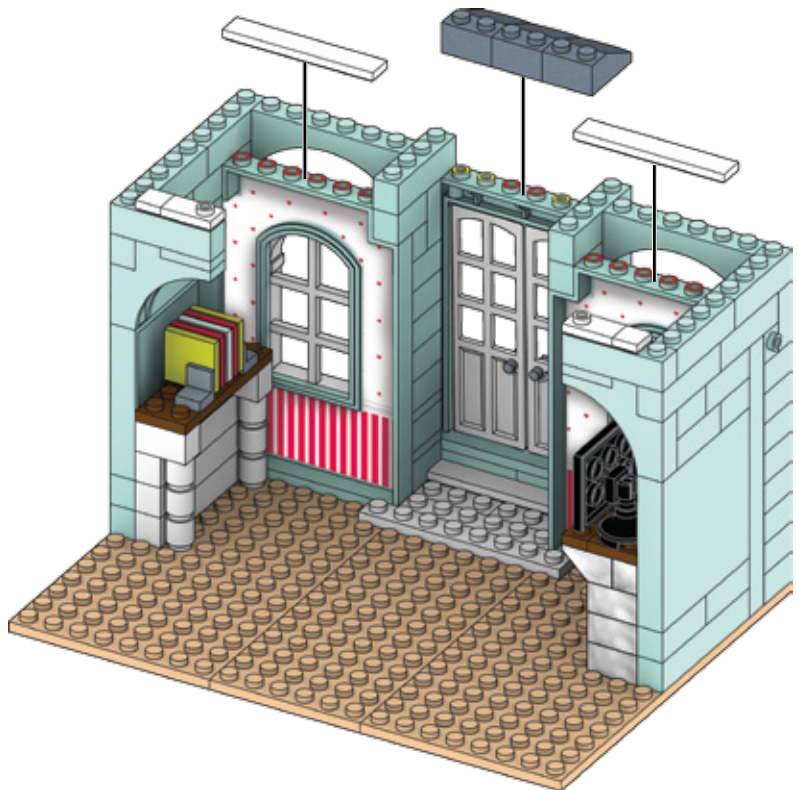



25



4x

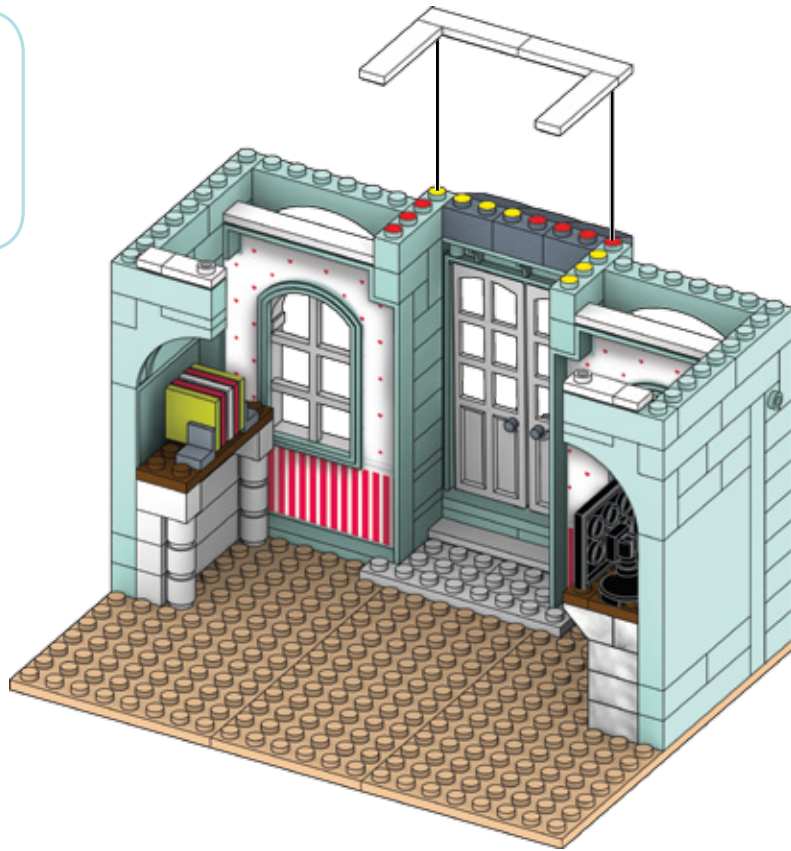

1

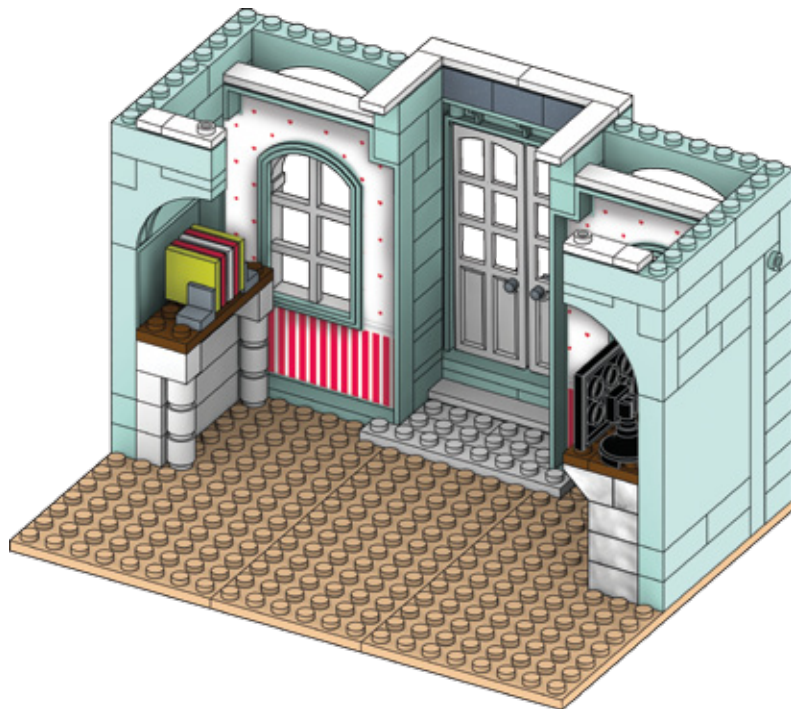

2



26



2x



2x



2x

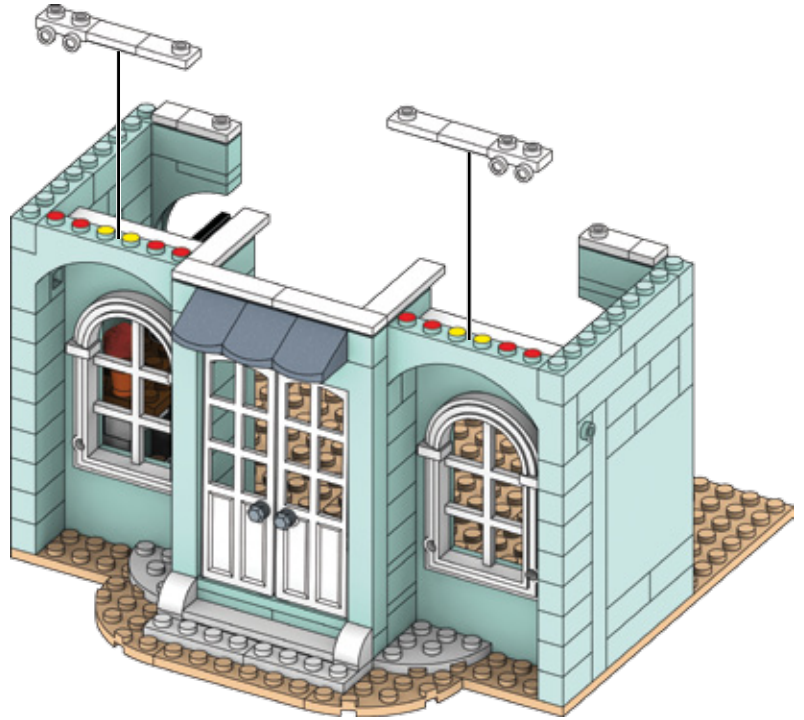

27



6x



2x

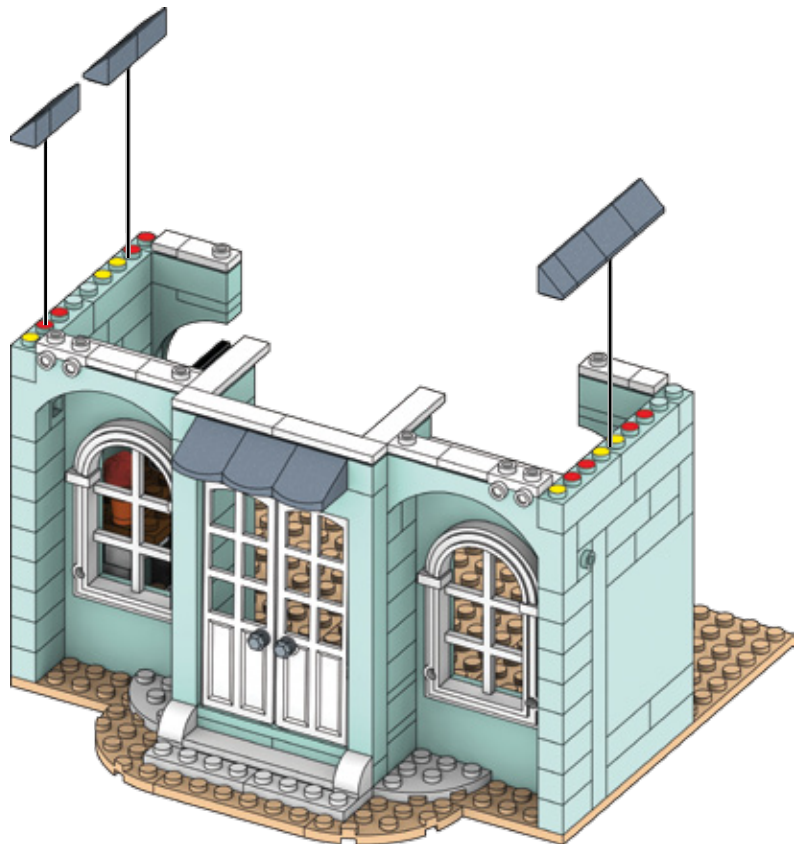



28



2x



2x



2x



x2

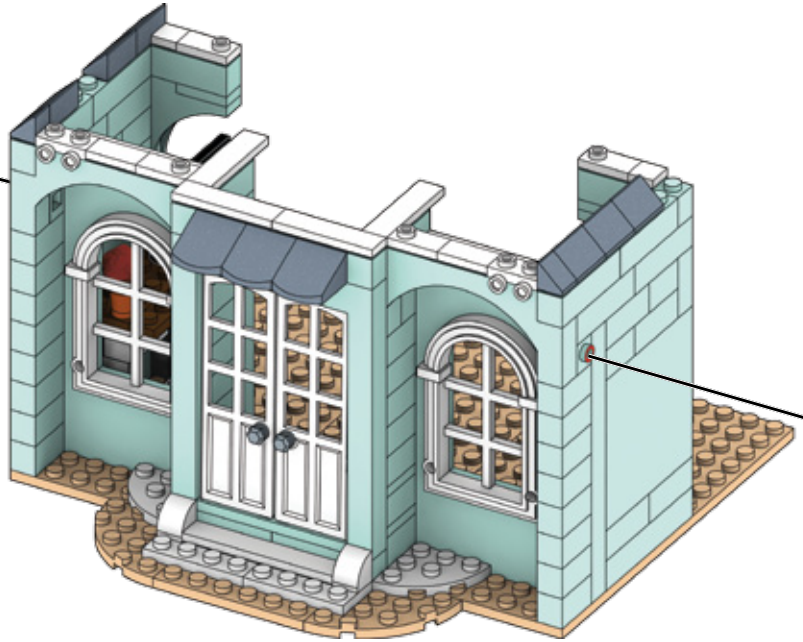

29



2x

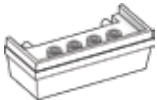

2x

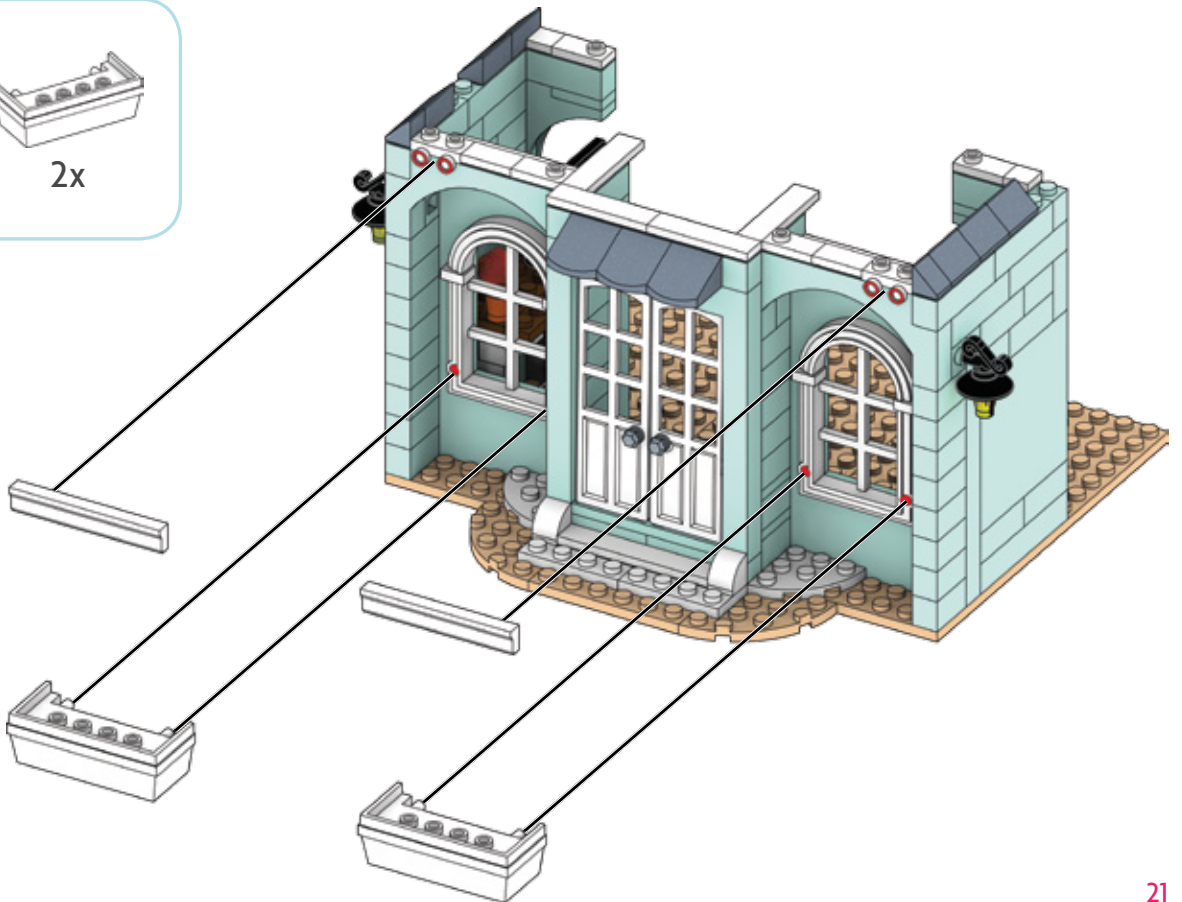



30



1x



1x



1x



1x



1x



1x



1x



1x



1x

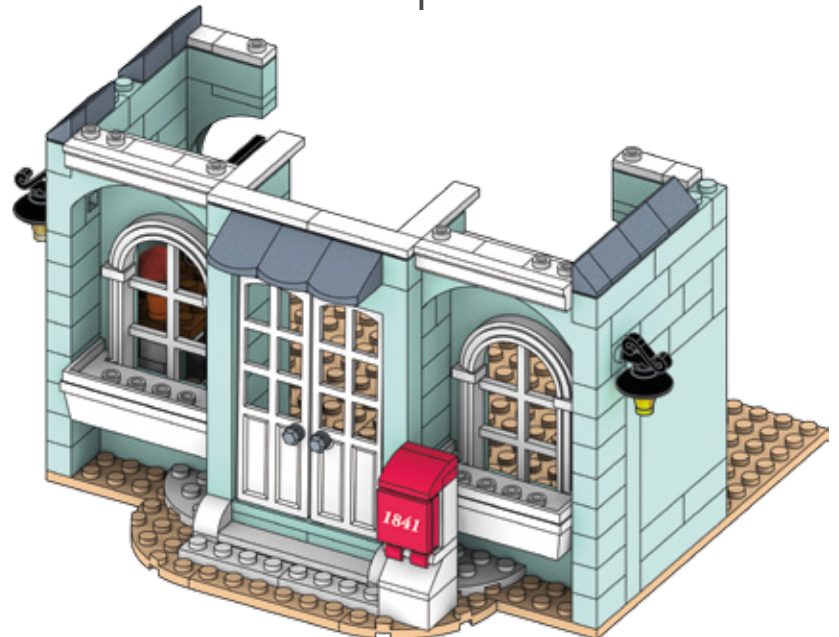
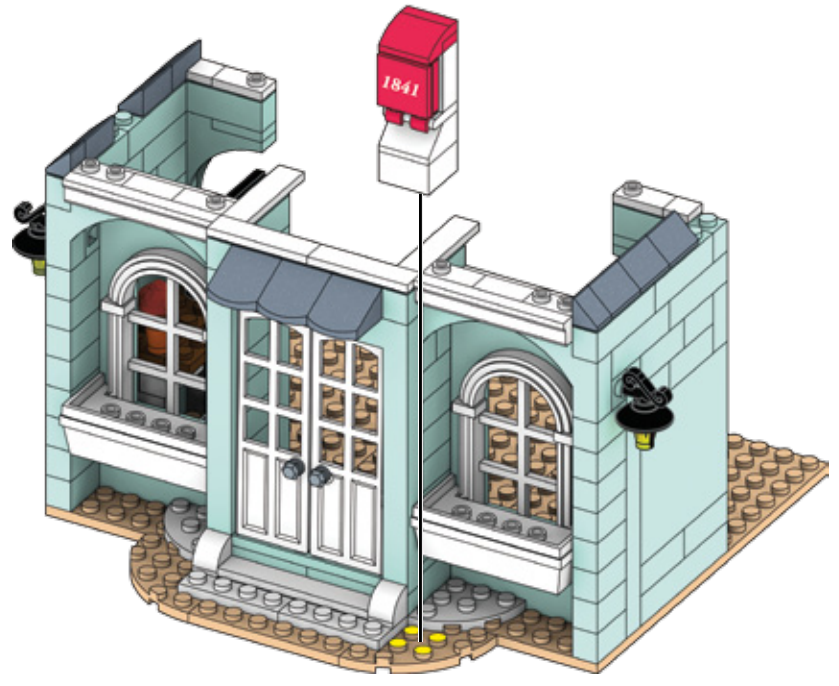
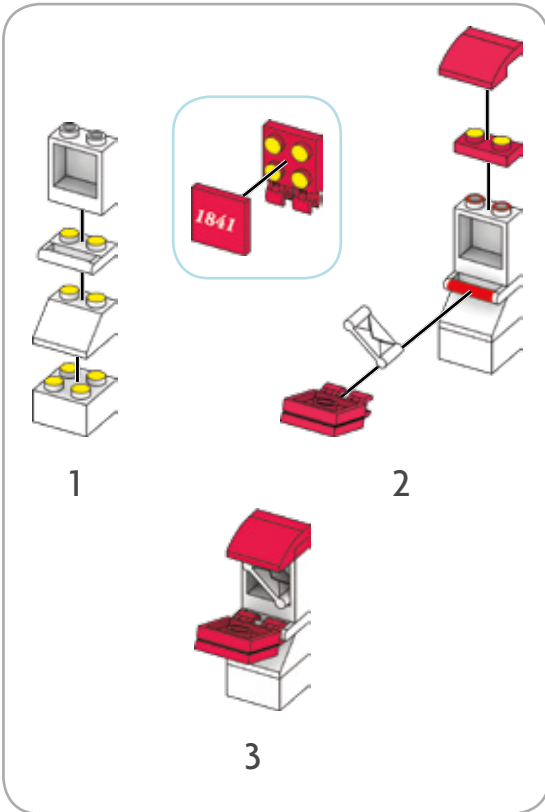



31



3x



1x

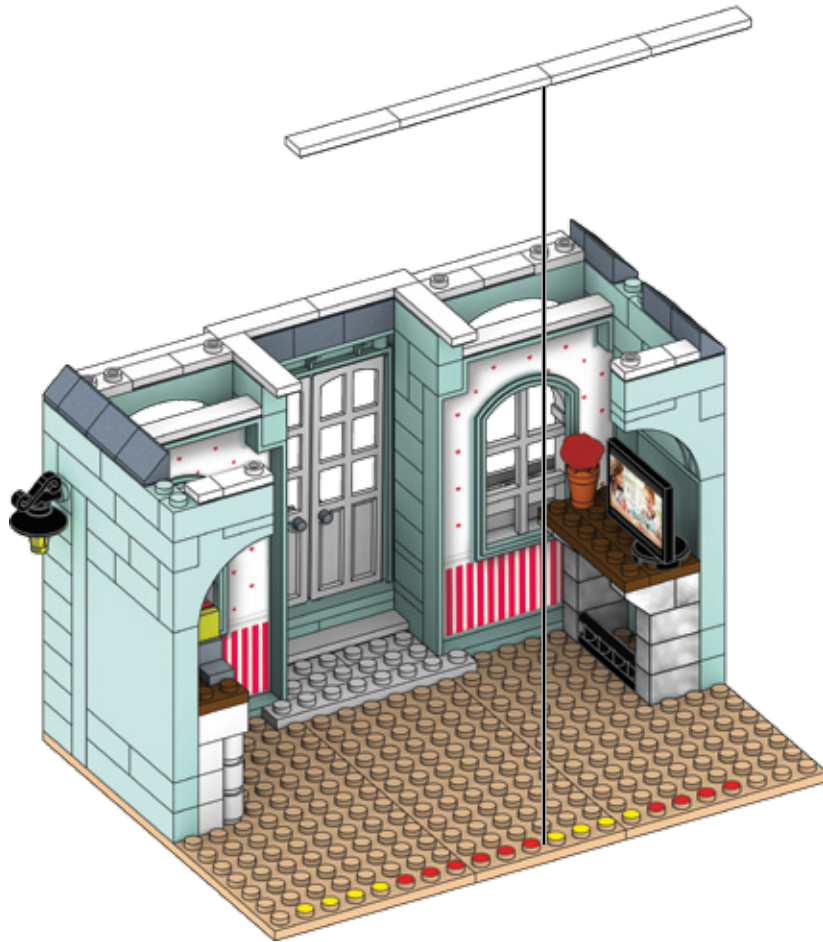



32

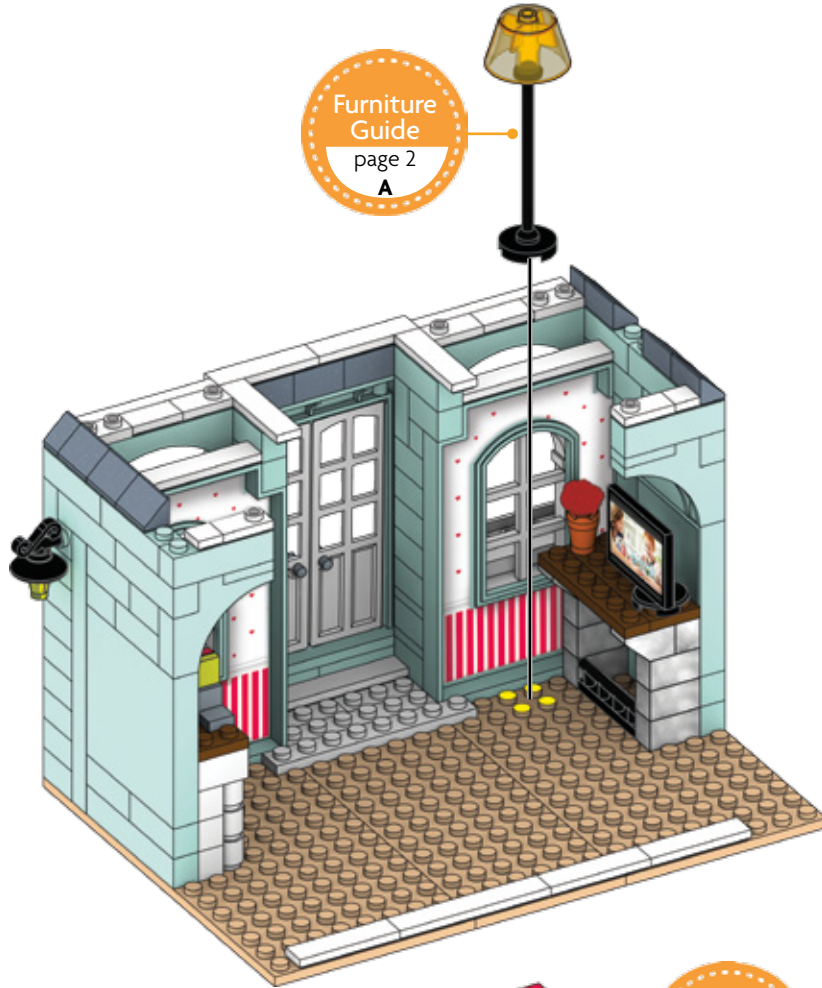

33

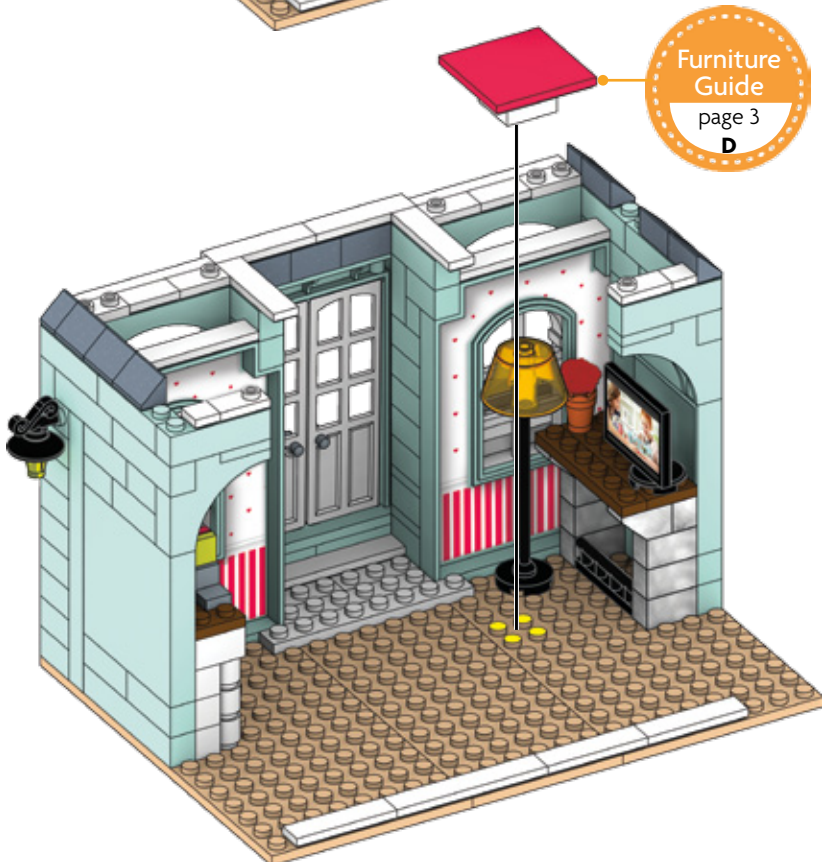



34

Furniture
Guide
page 8
G

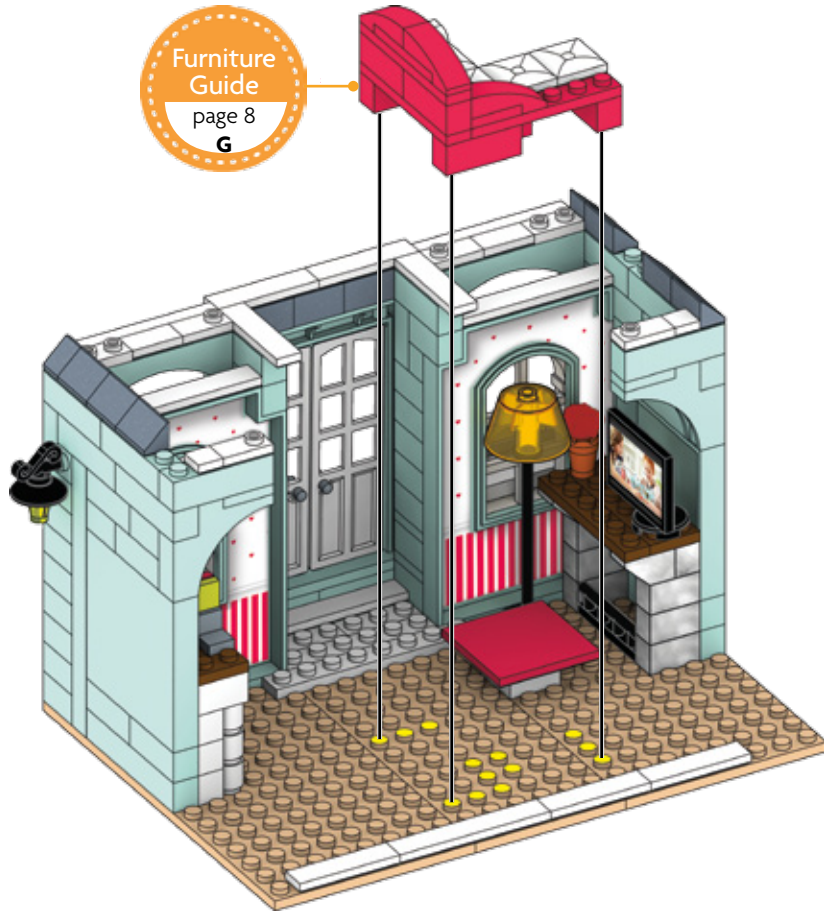

1

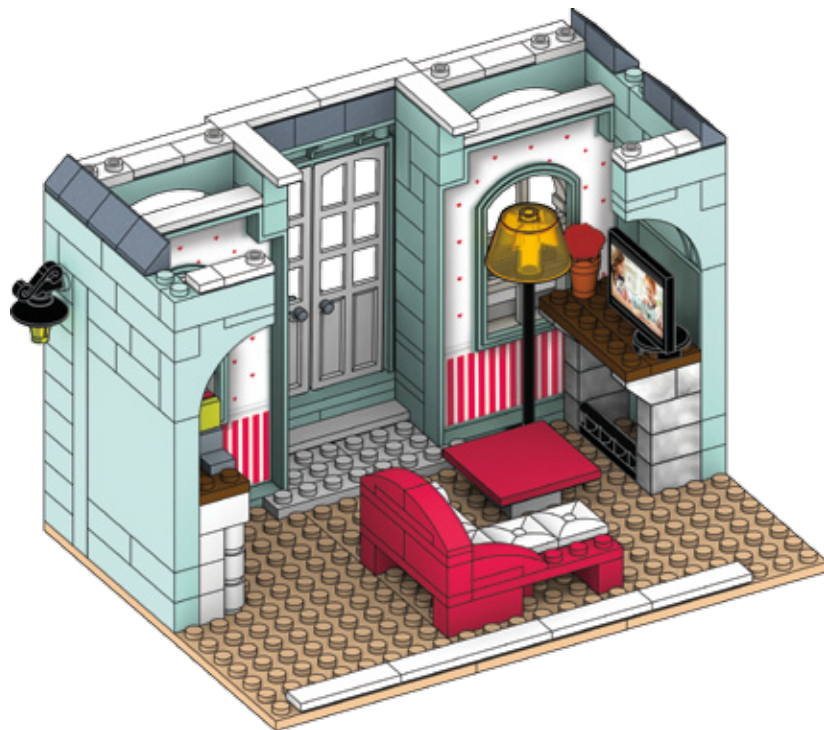

2



Next, let's get cooking by building the kitchen!



35



2x

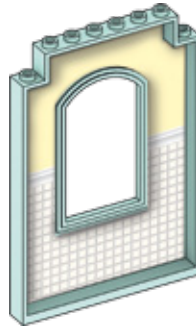

2x

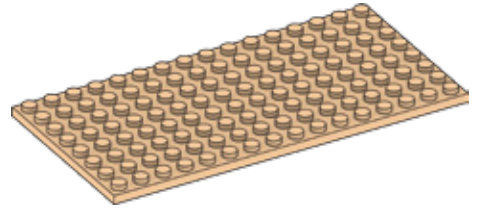

1x

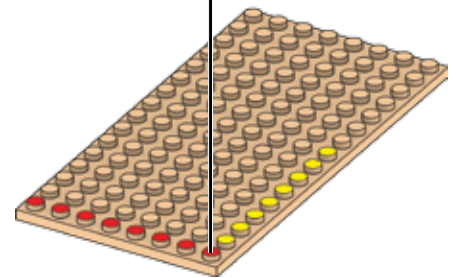
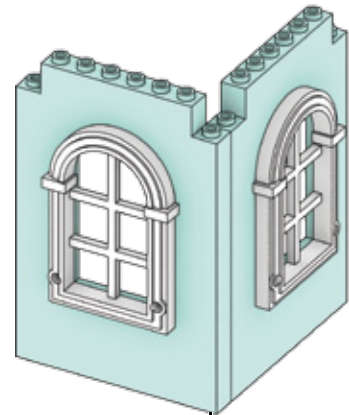
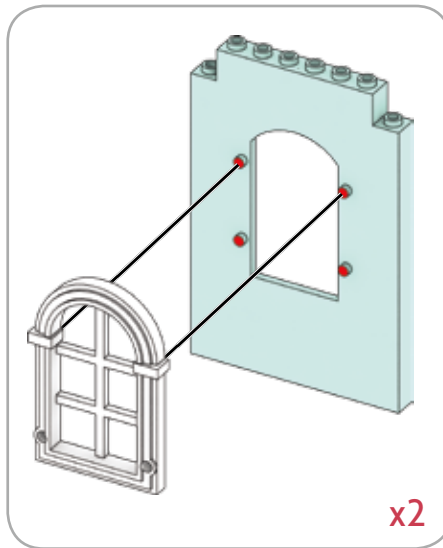

36



2x



1x

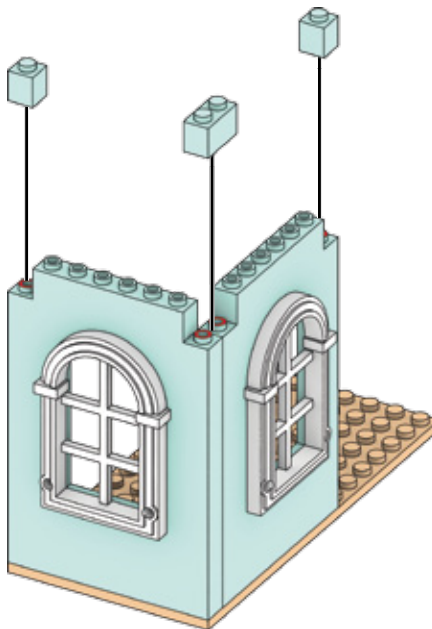



37

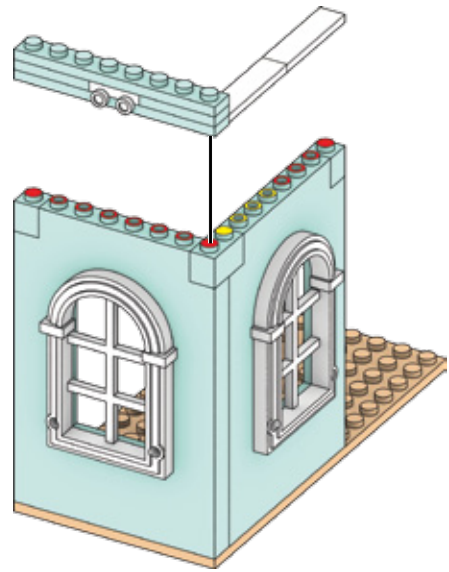
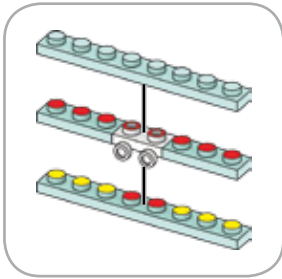
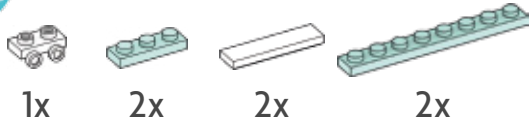

38

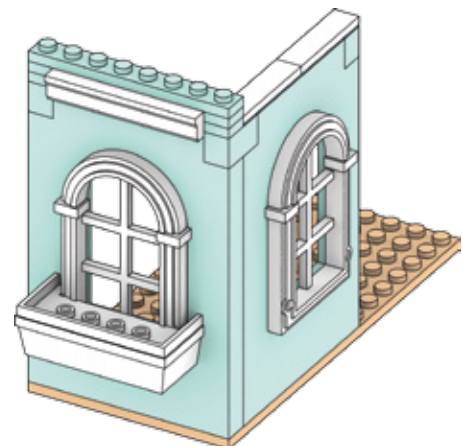
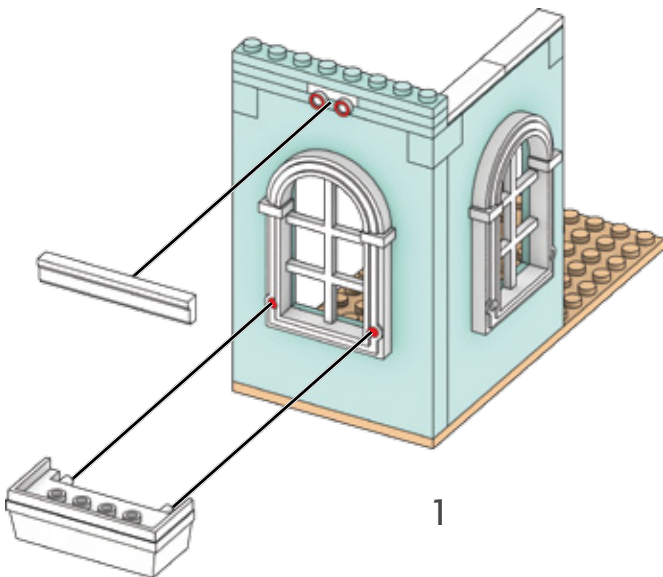
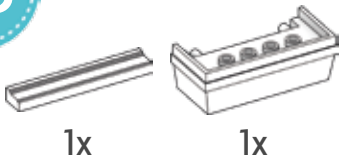



39

40

- 2x
- 5x
- 3x
- 2x

Furniture Guide
page 11
H

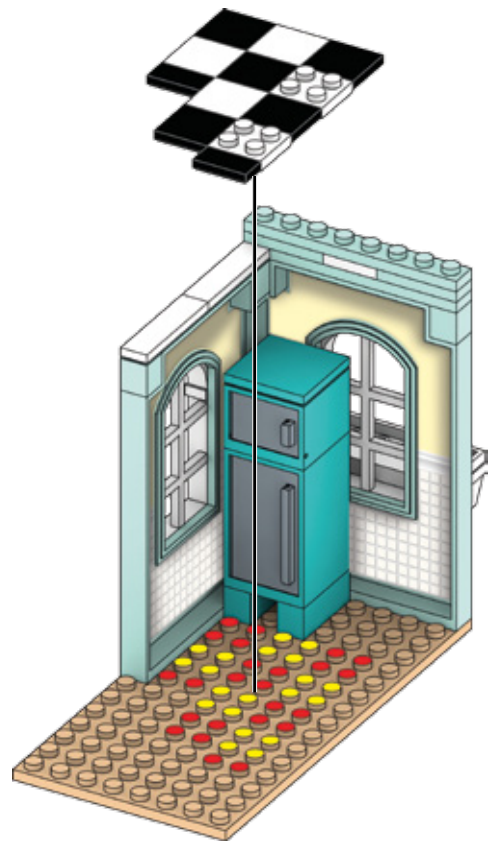
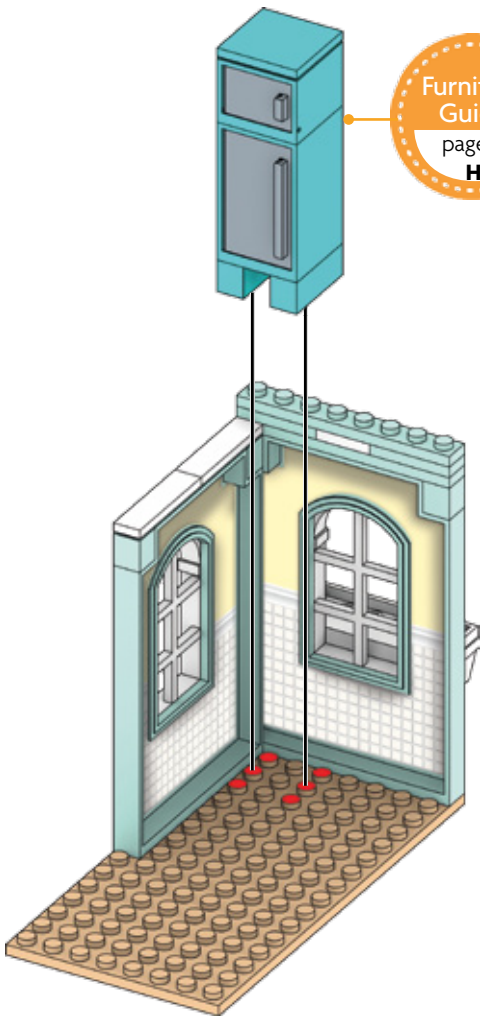



41

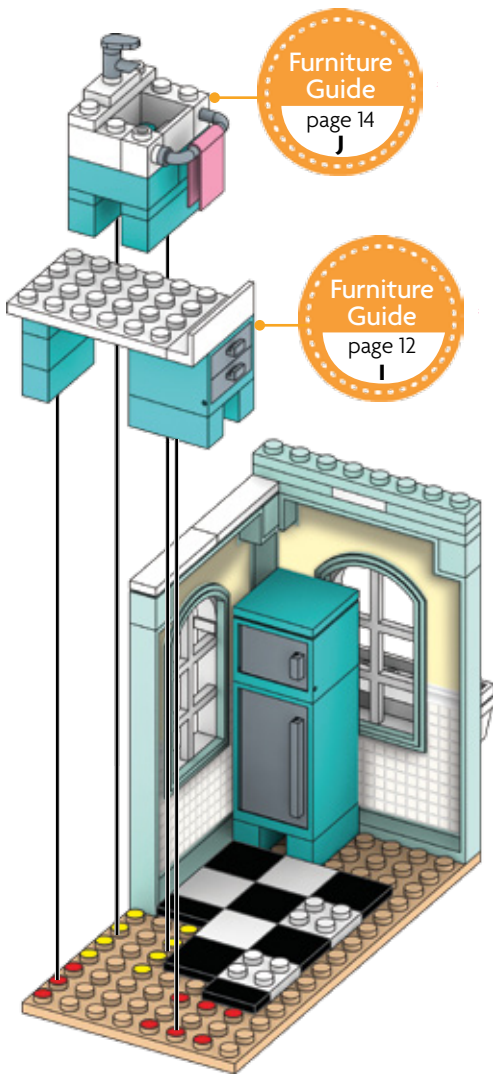

1

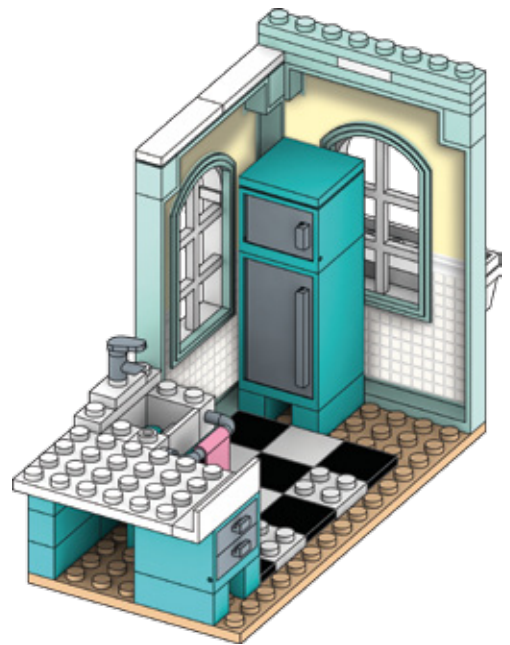

2



42

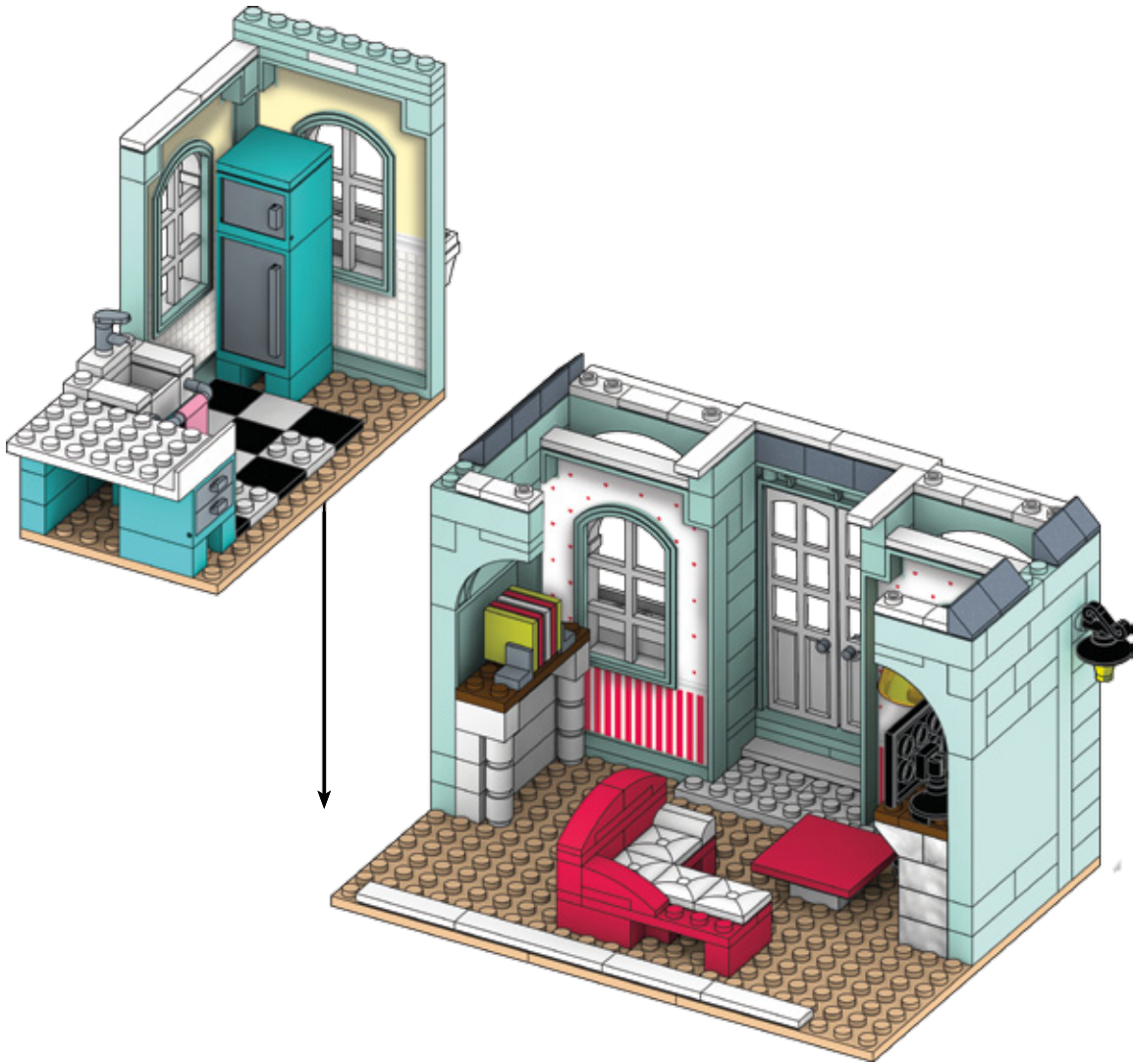



43



3x



1x



1x



1x



2x

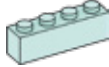

1x



4x

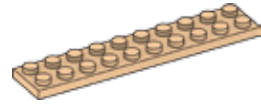

1x

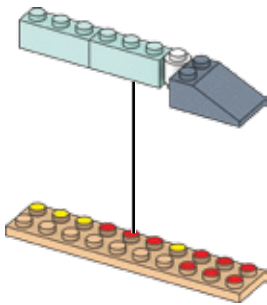

1

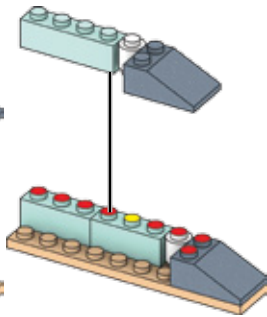

2

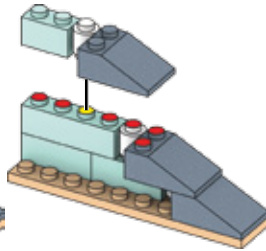

3

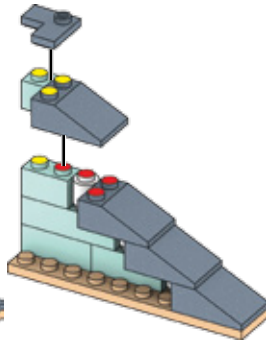

4

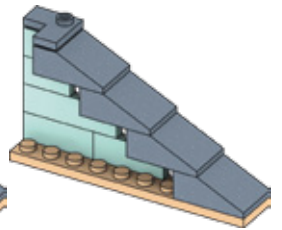

5

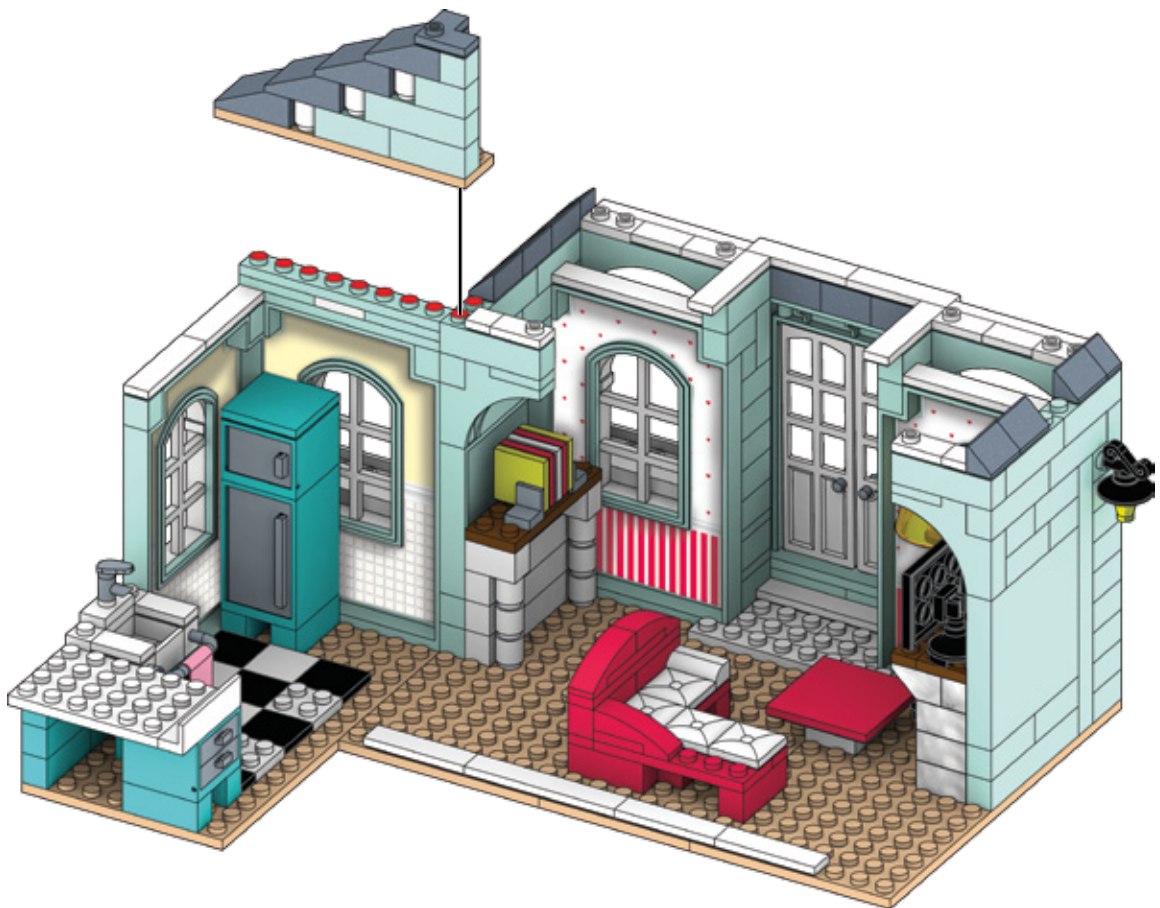

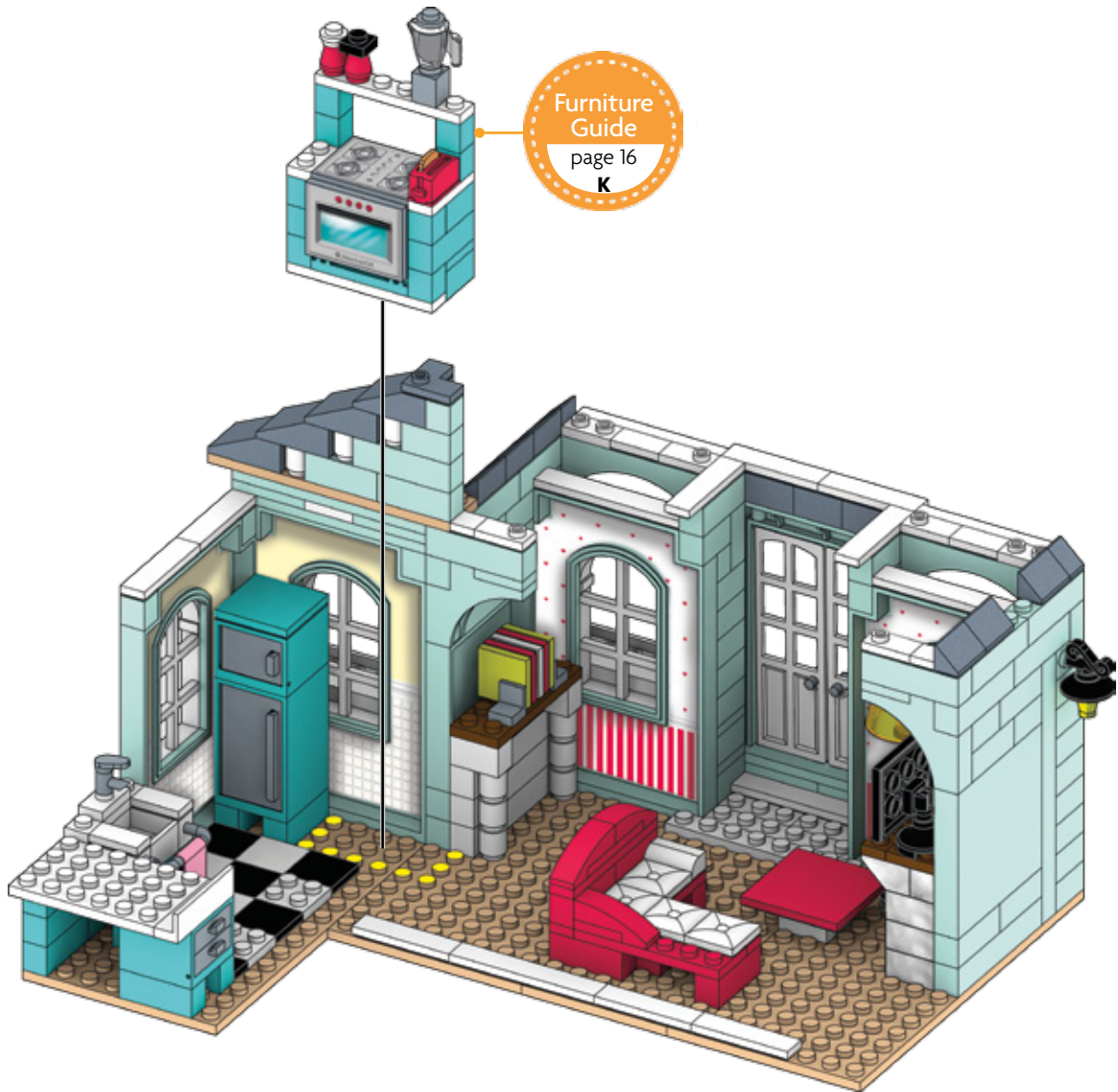



45



1x



1x

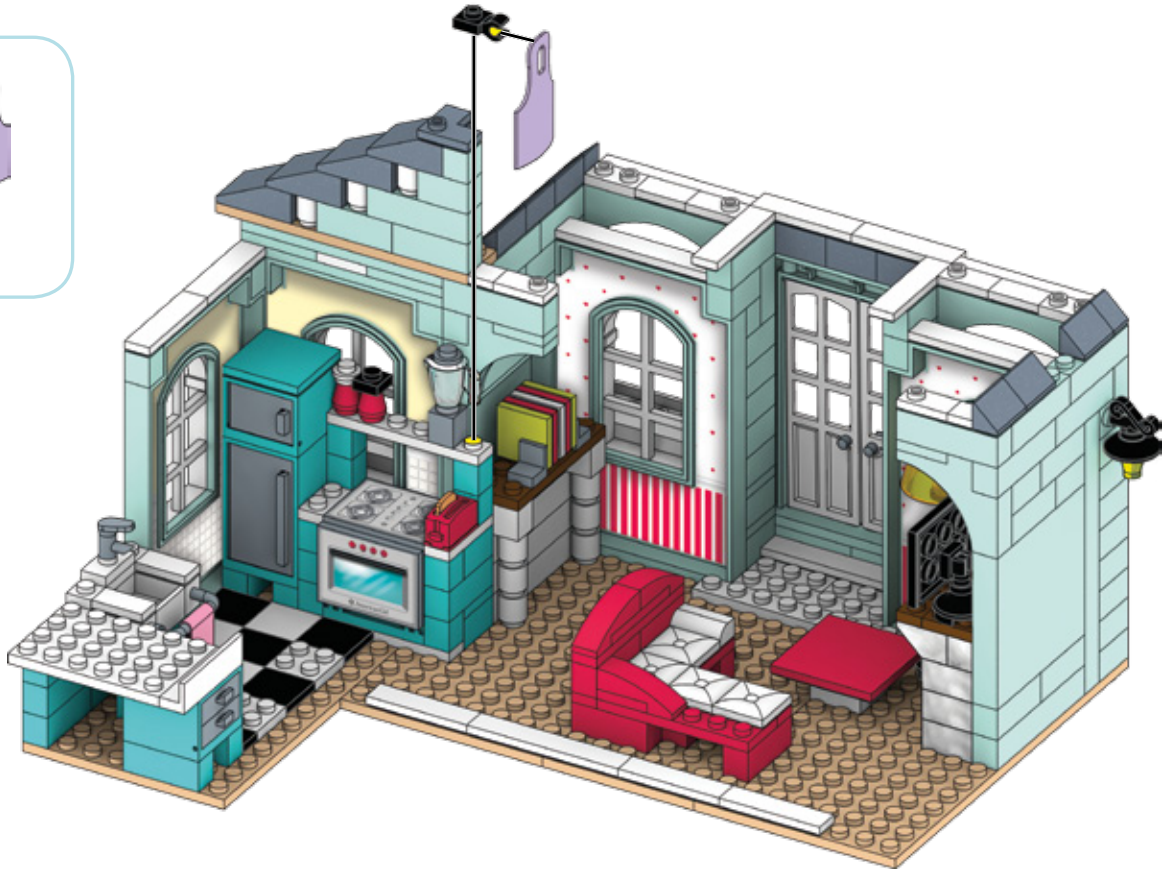

46



2x



2x



1x



1x

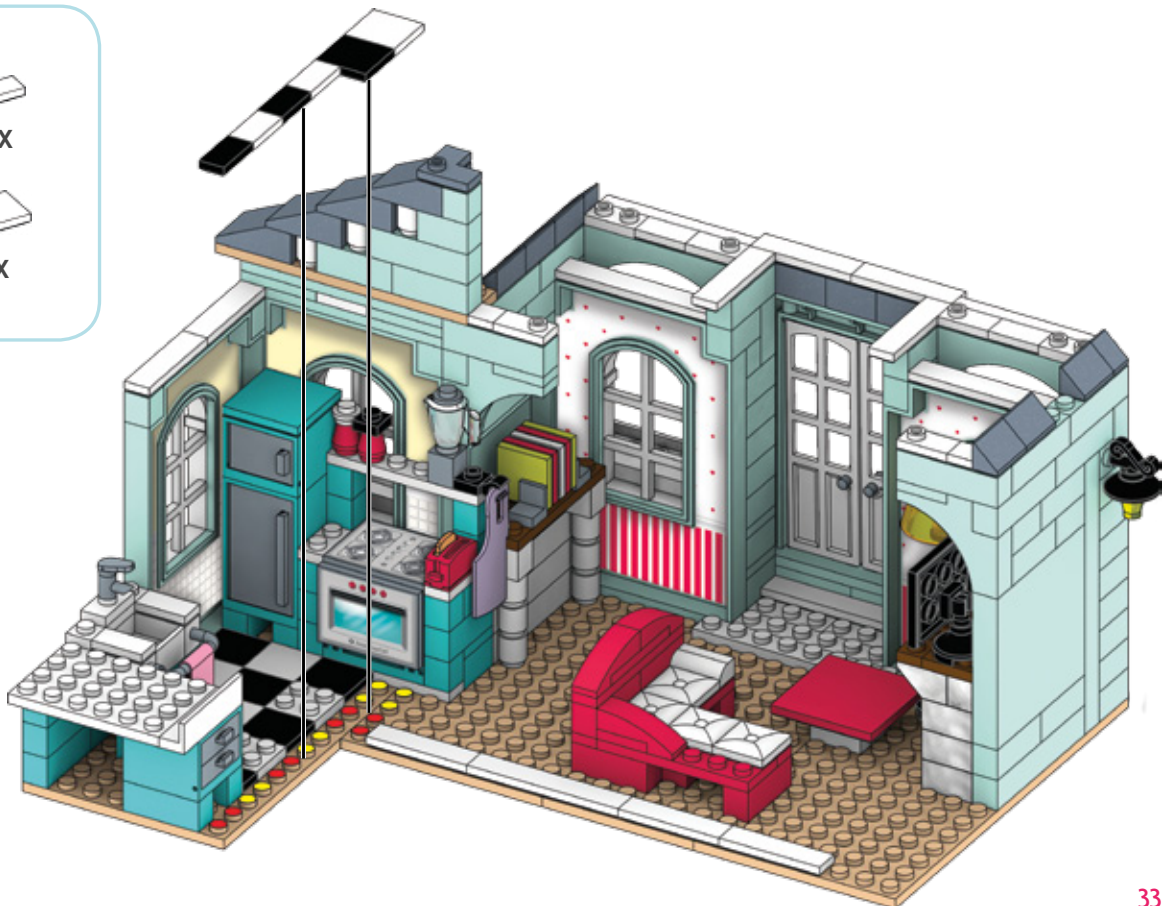



47

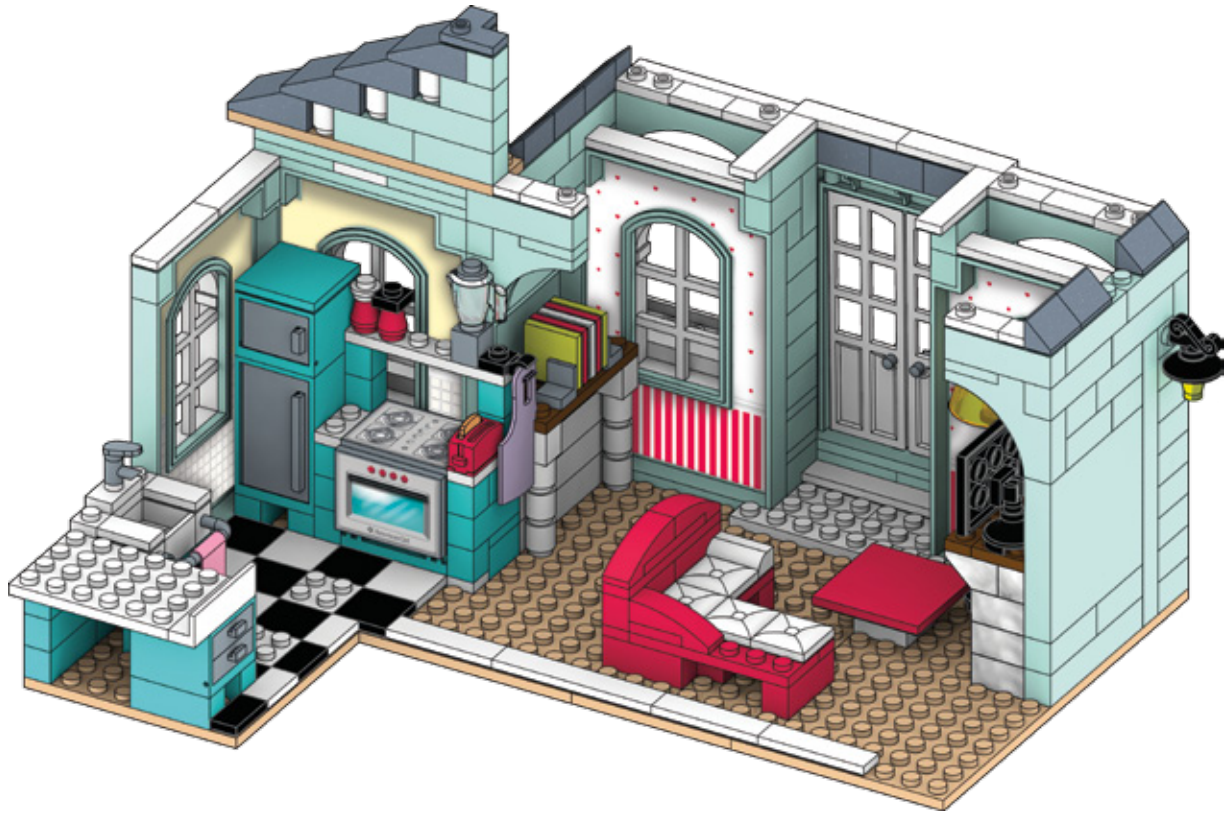

Sweet Ideas

Grace is constantly coming up with ideas—from new recipes to thoughts on getting the baking business off the ground. When Maddie and Ella come over, they brainstorm menu ideas. Some are yummy—chocolate-strawberry cupcakes, anyone? Others are a little wild, like bone-shaped cakes for dogs. What other ideas could they have?





Now let's freshen up by building the bathroom!



48

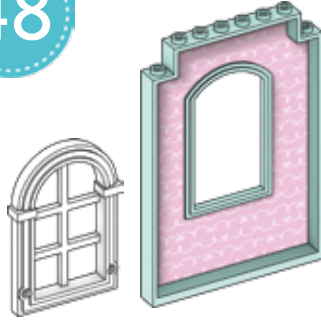

1x

1x

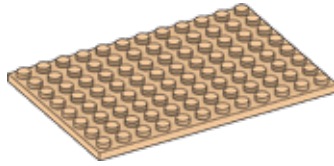

1x

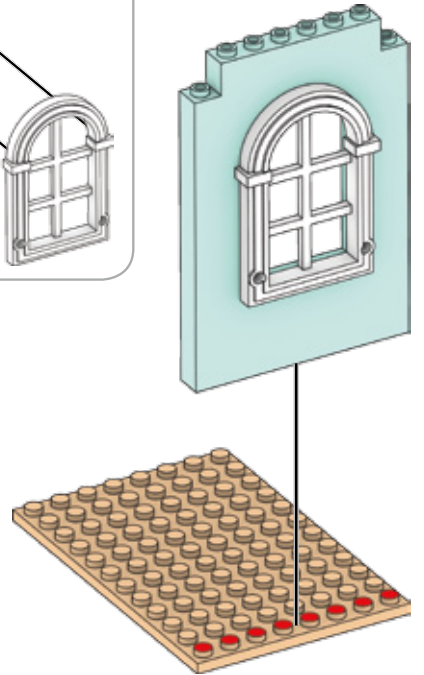
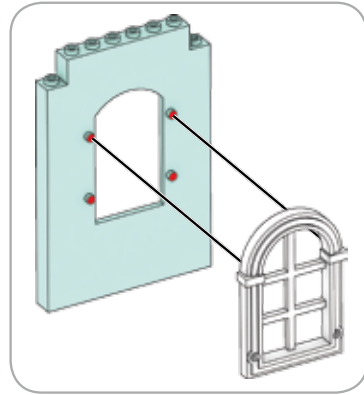

49

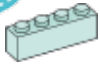

3x

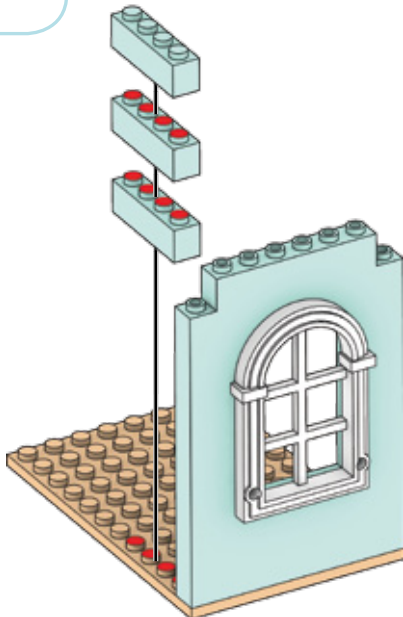

50



1x

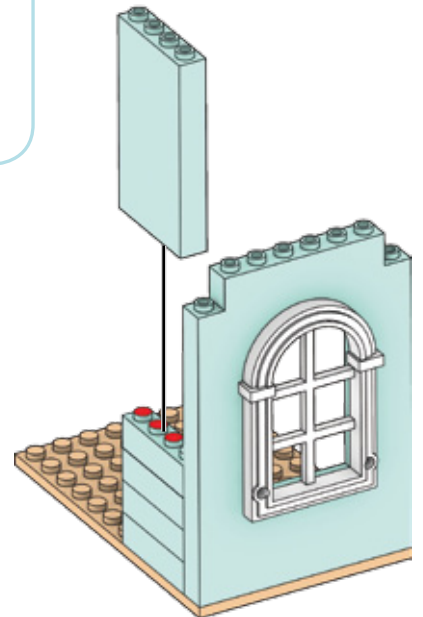



51



2x

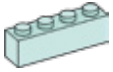

1x

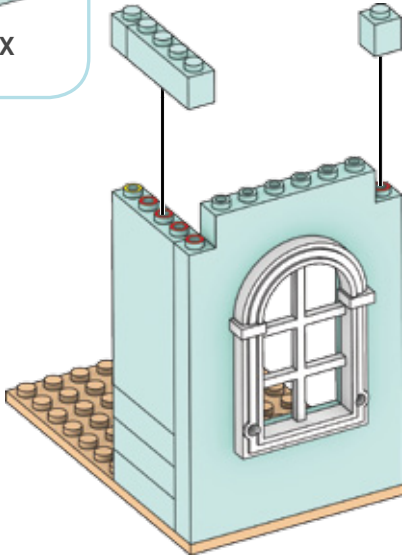

52



1x



2x

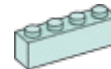

1x



2x

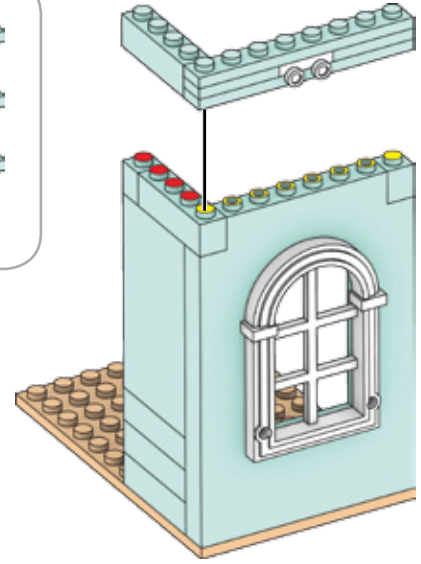
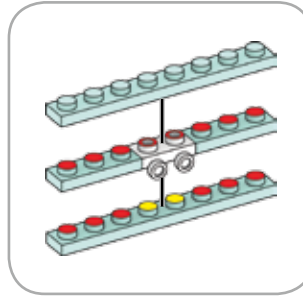

53



1x



1x

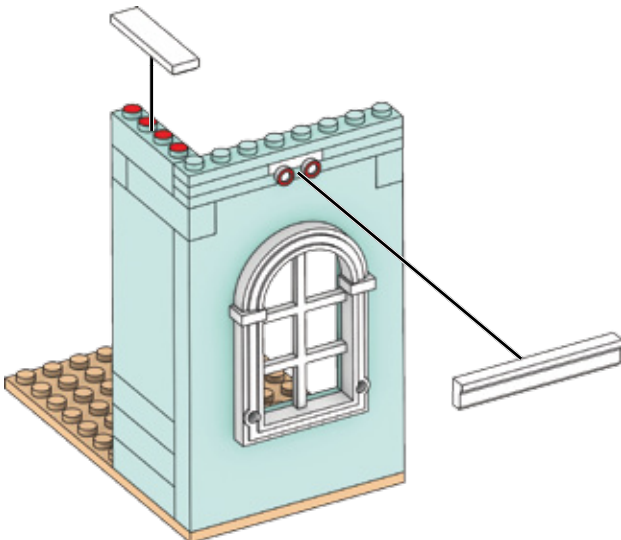

1

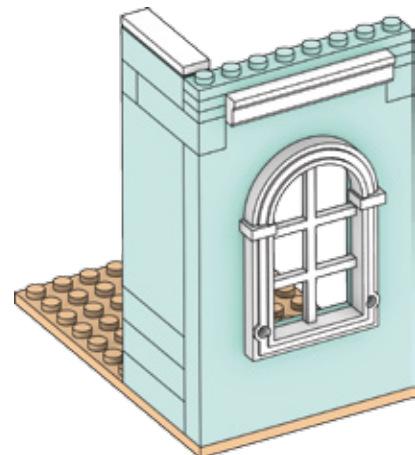

2



54

55

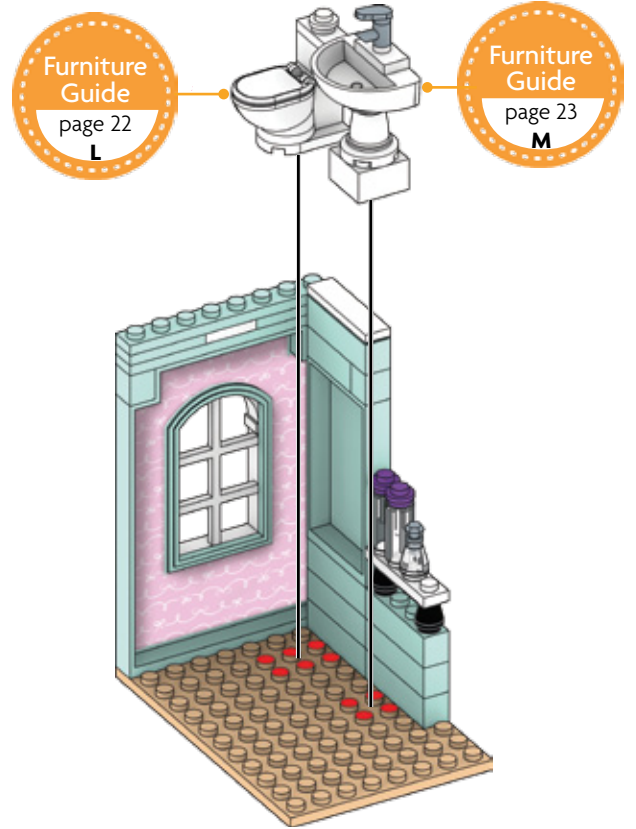
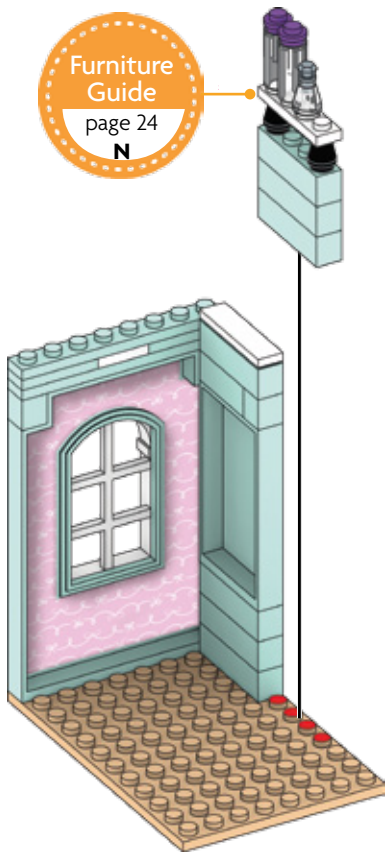



56

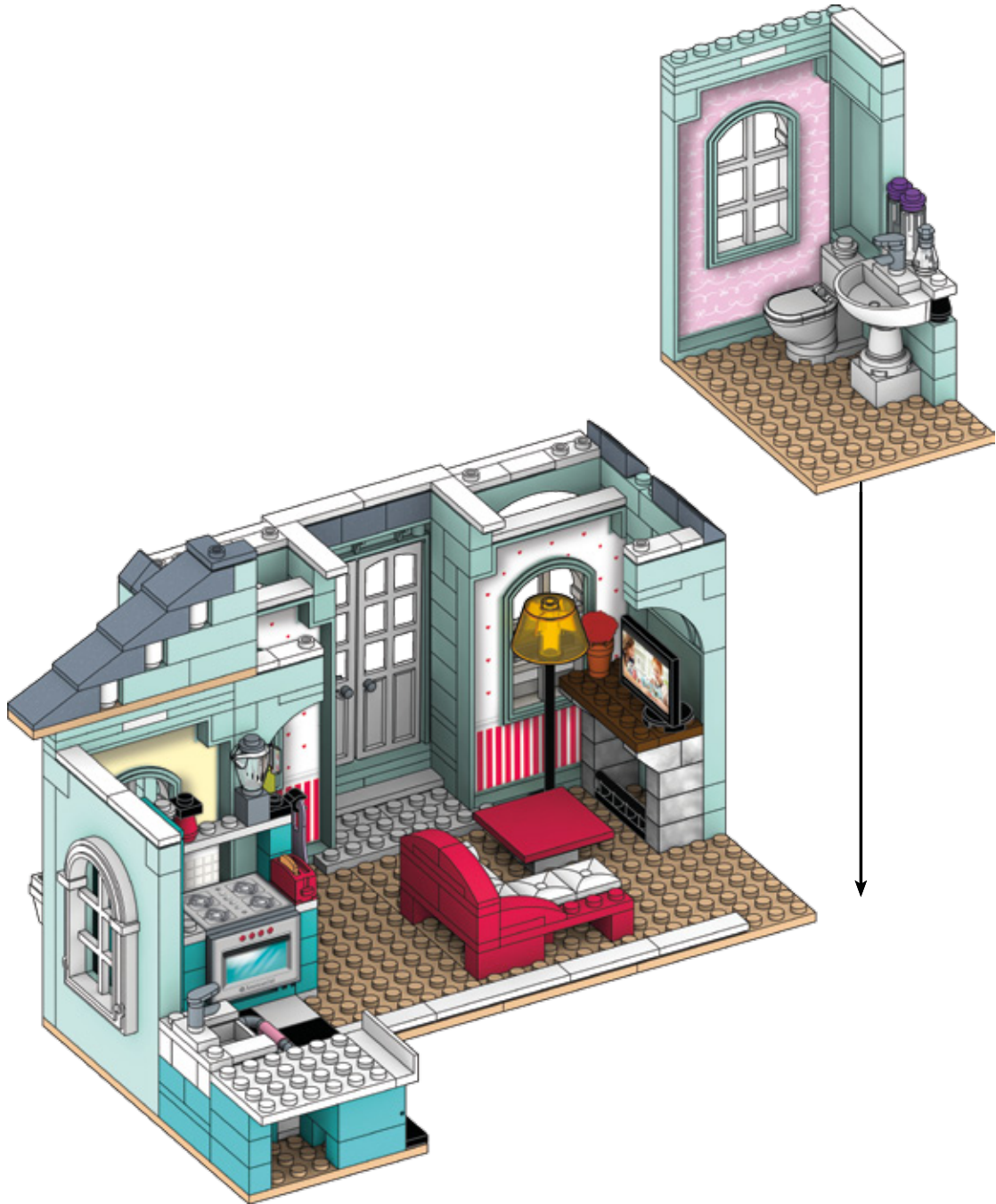



57



3x



1x



1x



1x



2x

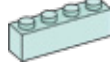

1x



4x

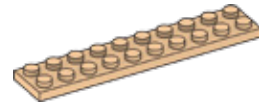

1x

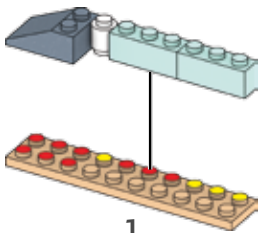

1

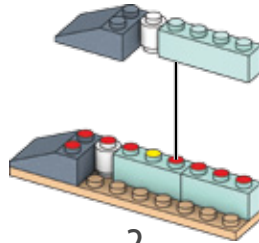

2

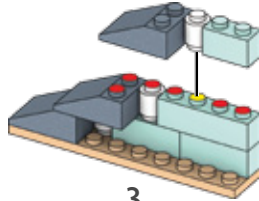

3

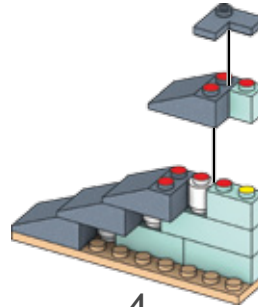

4

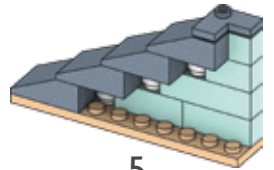

5

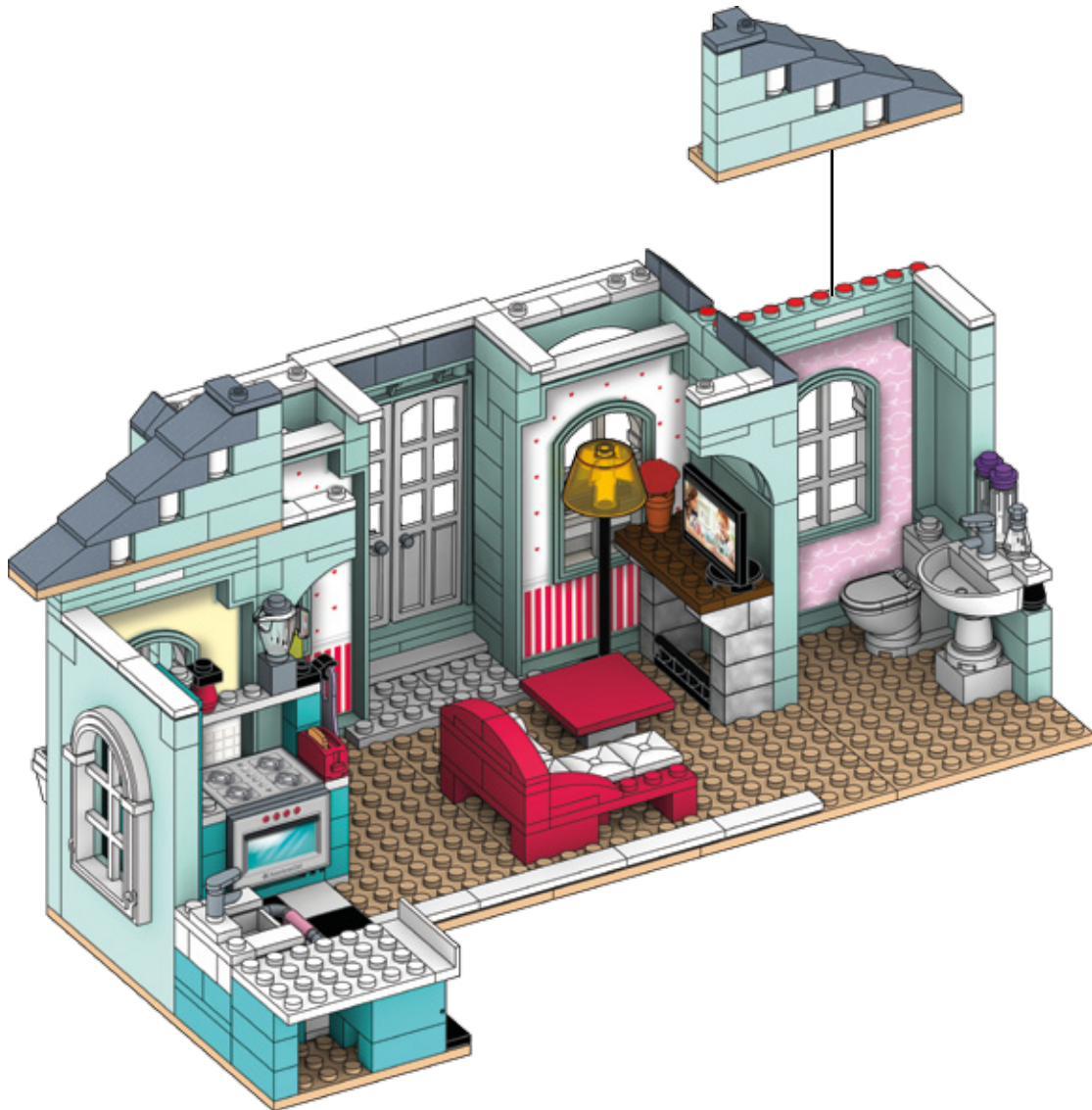



58



1x

Furniture
Guide
page 2
B





59

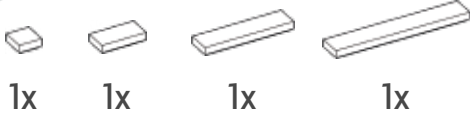



60



Everyone's Talent Shines

The girls decide to test their business idea by baking delicious treats right in Grace's kitchen. Maddie loves art and wants to design a website to take orders online. Ella, the math whiz, will handle numbers and money. Then Grace has another big idea: maybe they can donate some of their profits to charity! What happens next?





Let's get comfy and build the bedroom!



61

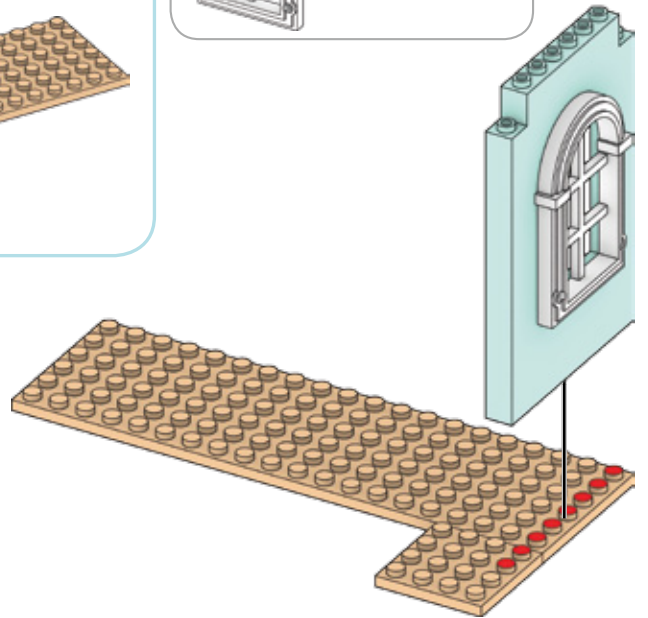
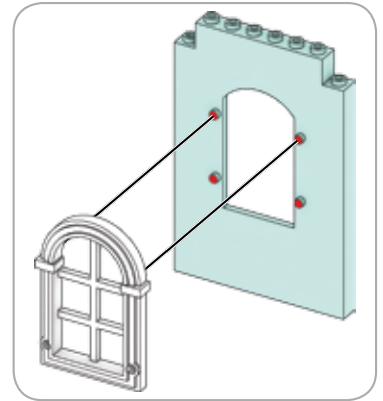
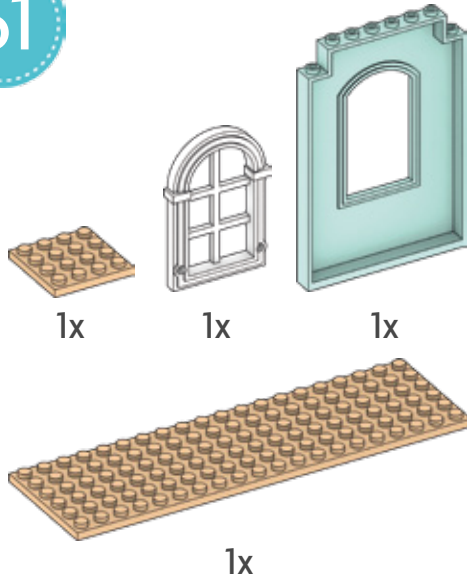

62

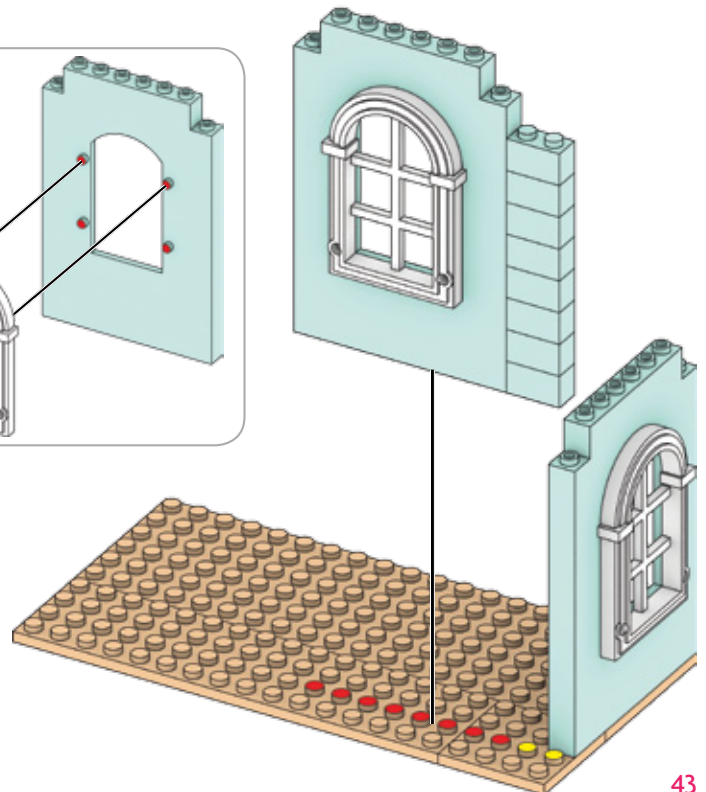
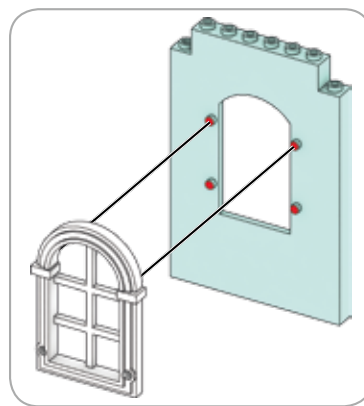
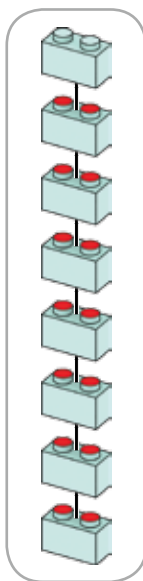
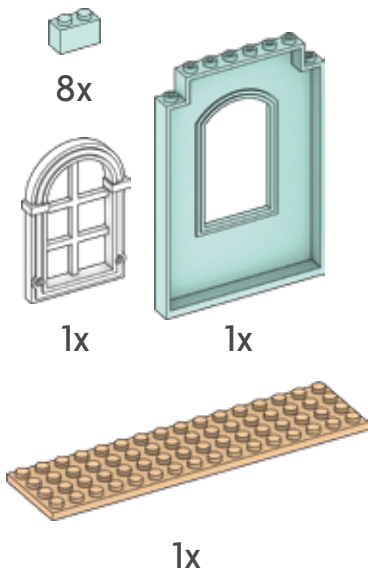



63



14x

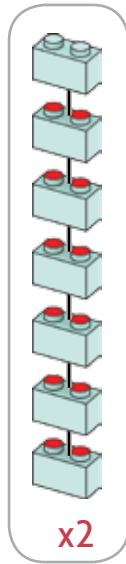

x2

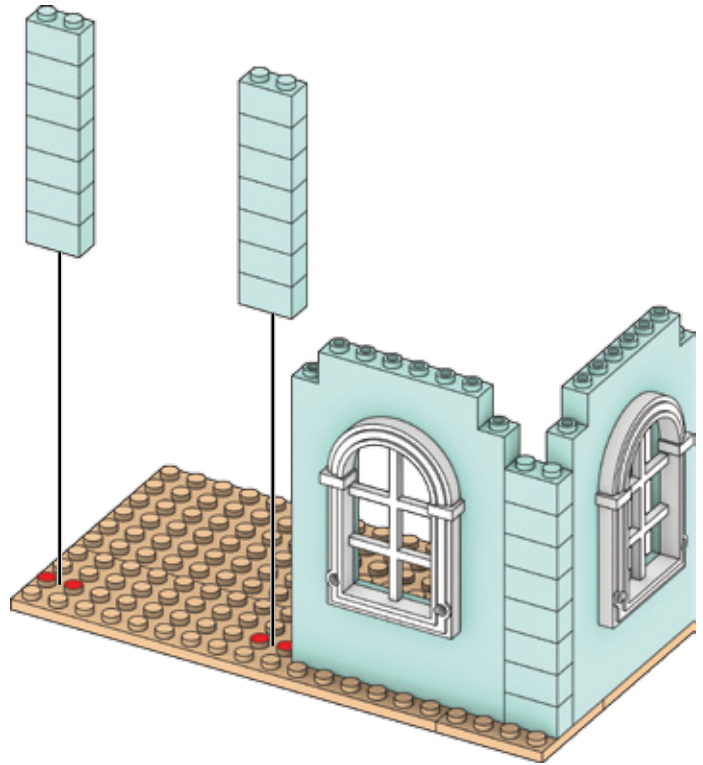

64



2x

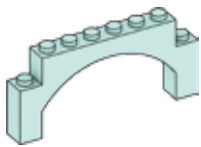

1x

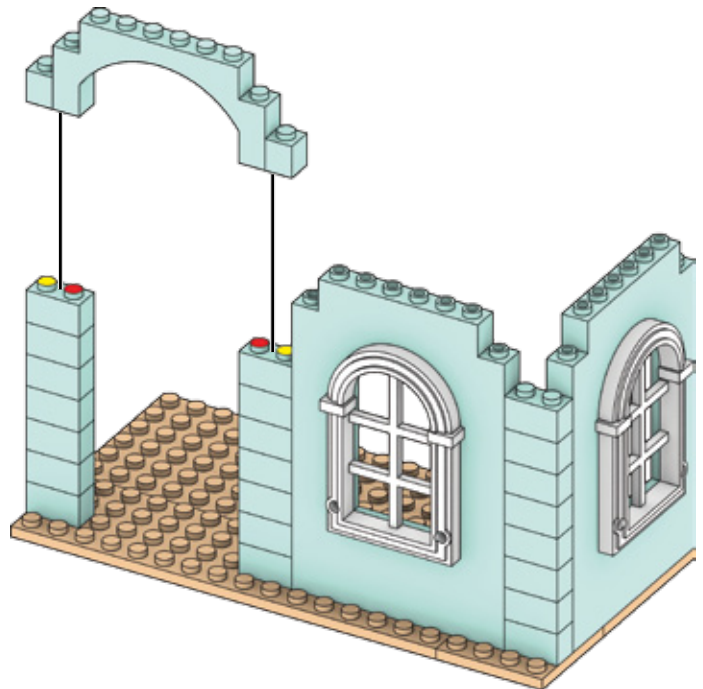



65



2x



2x

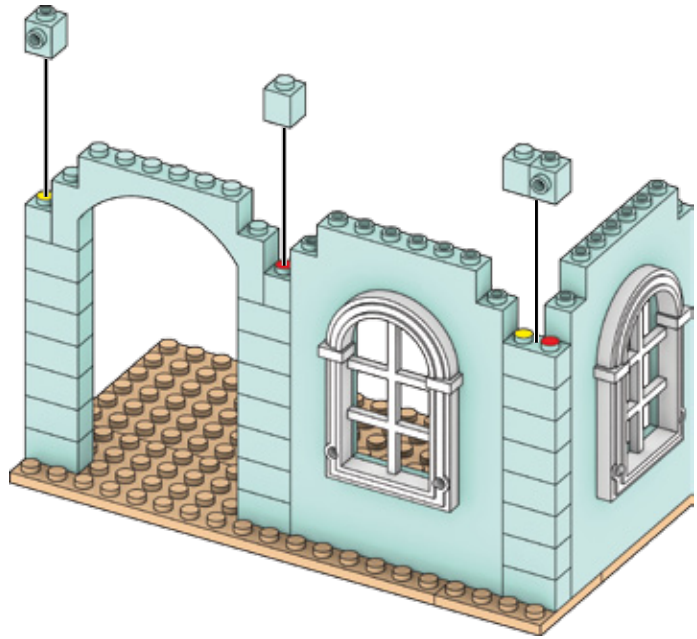

66



2x



2x

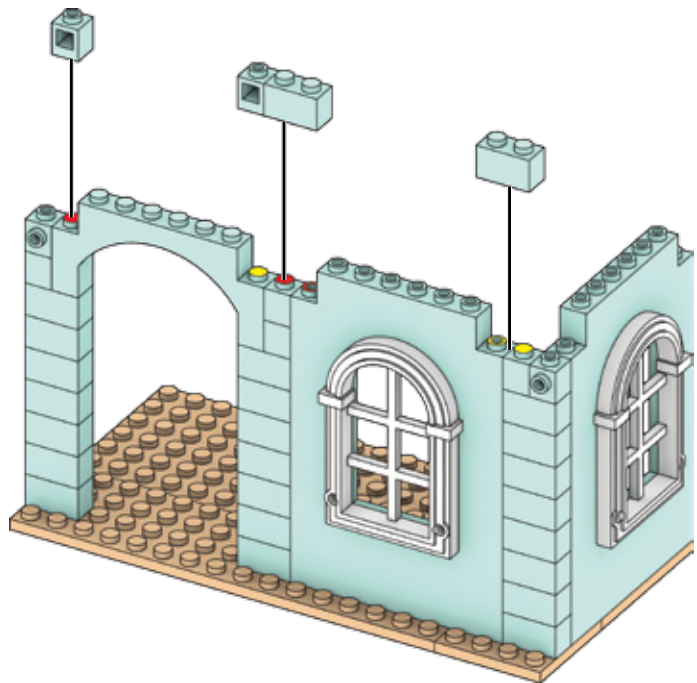



67



1x

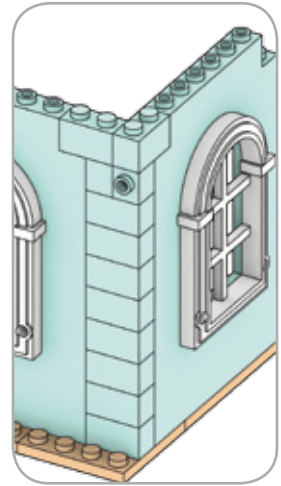
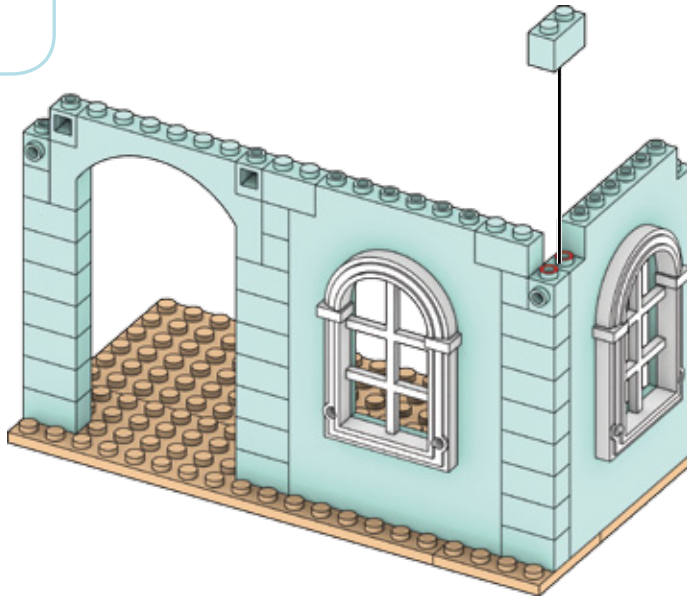

68



2x

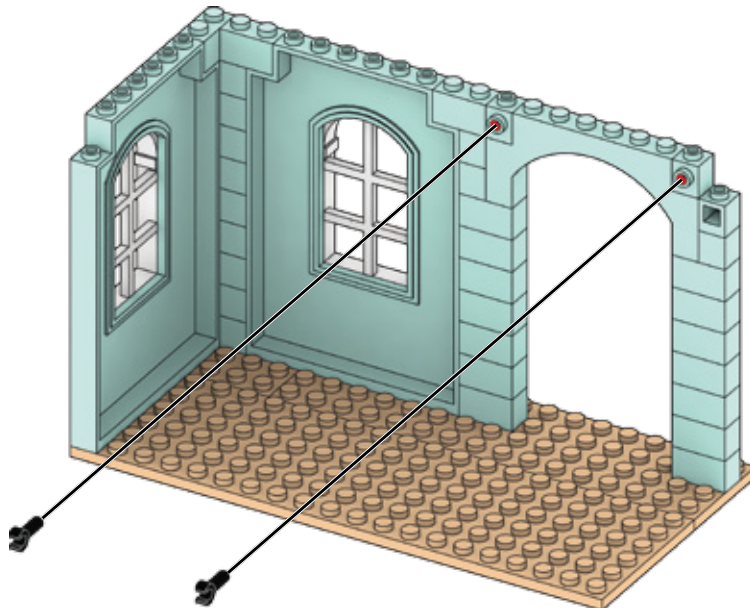



69

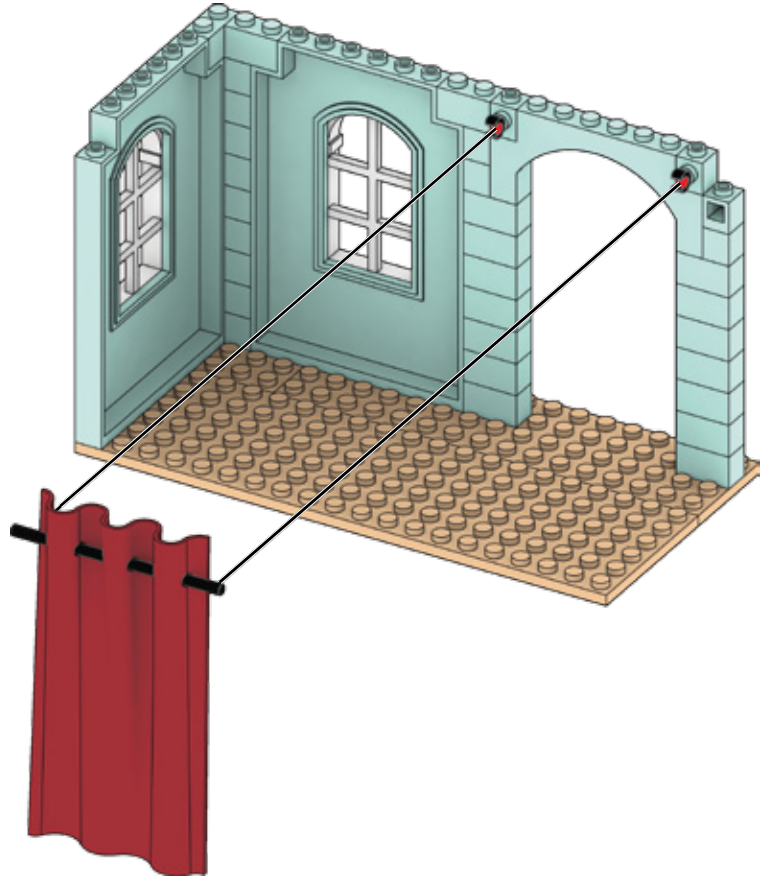
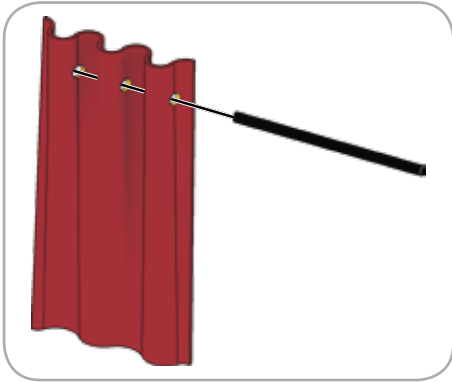
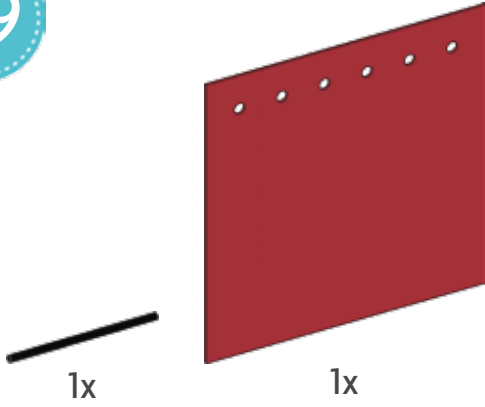

70

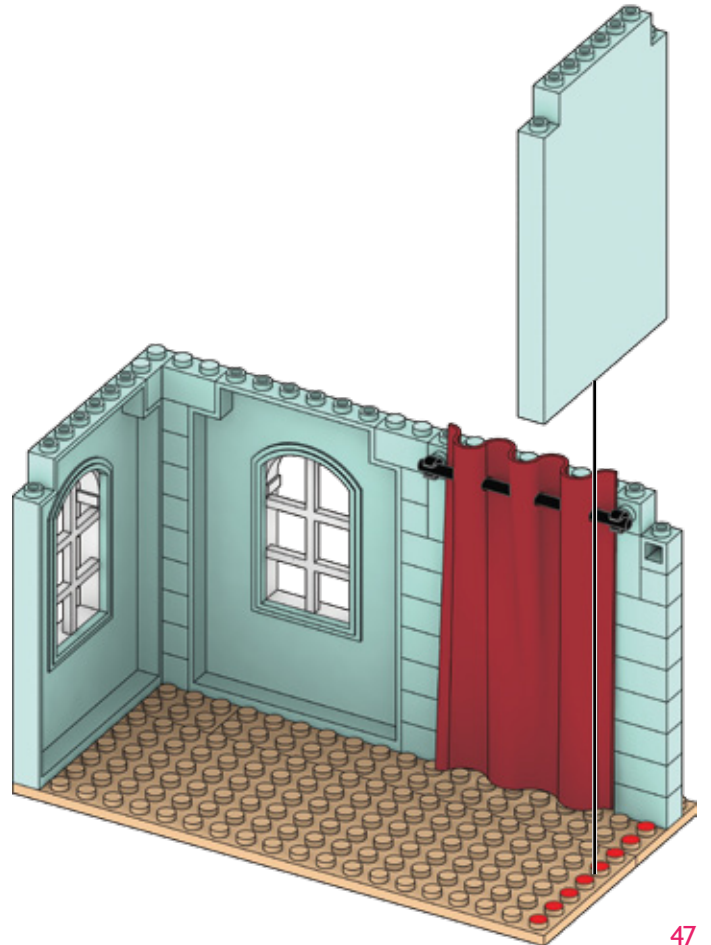



71



1x

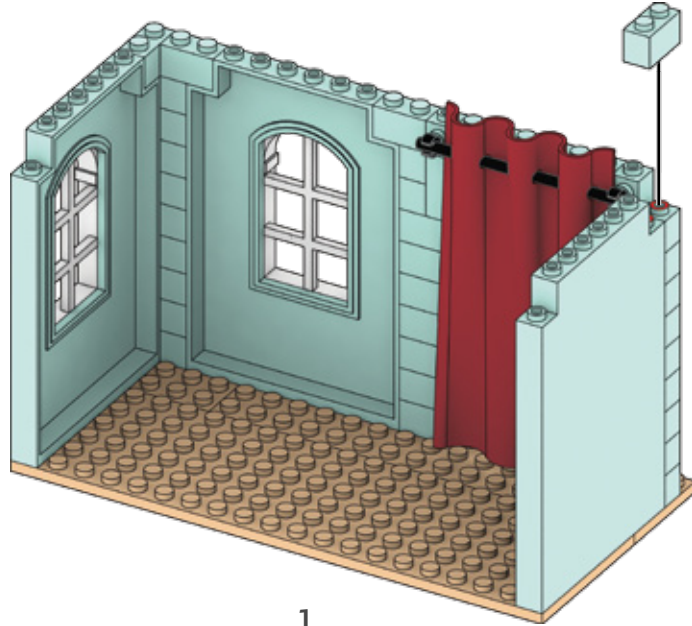

1

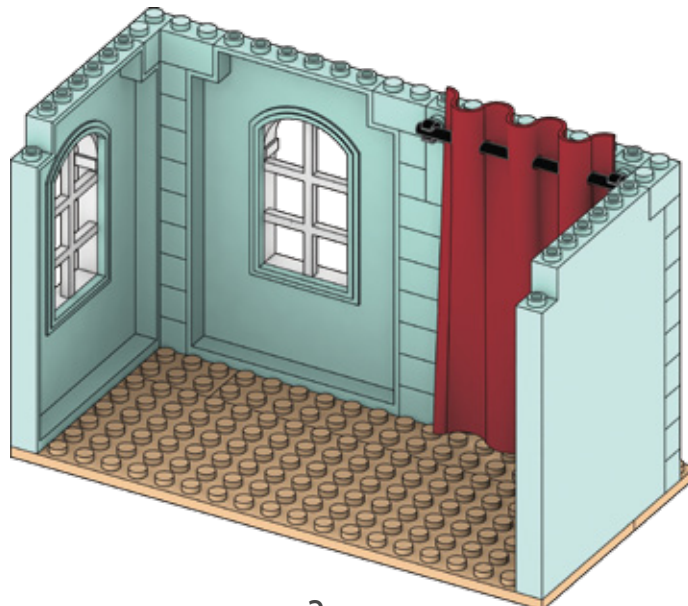

2



72



2x



2x

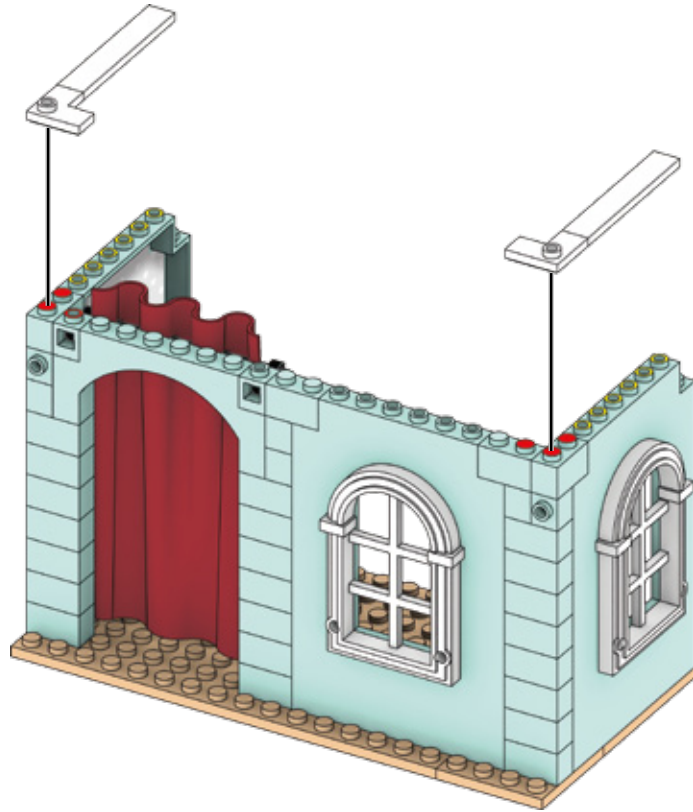

73



1x



2x



1x

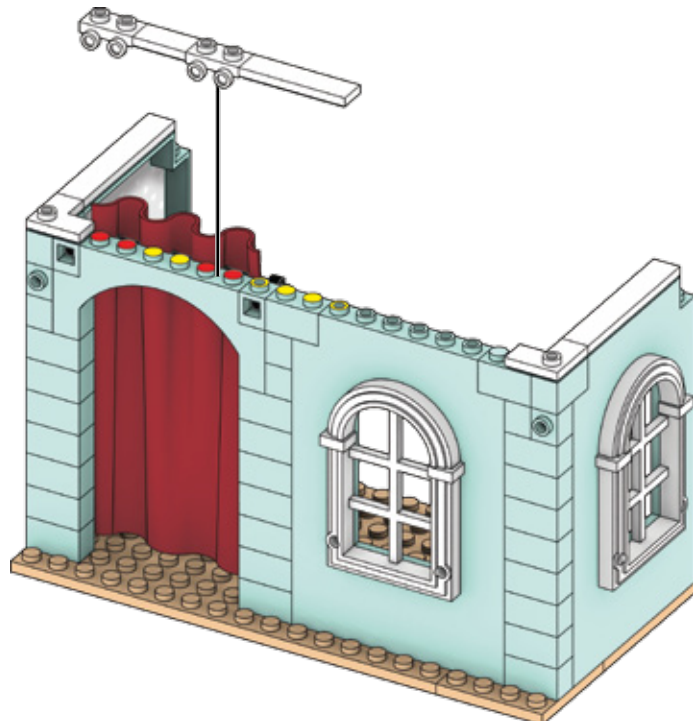



74



3x

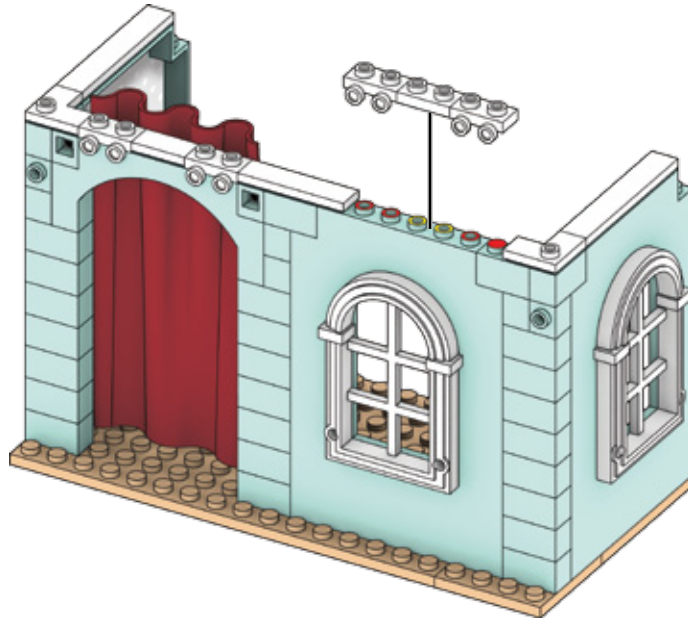

75



1x



1x

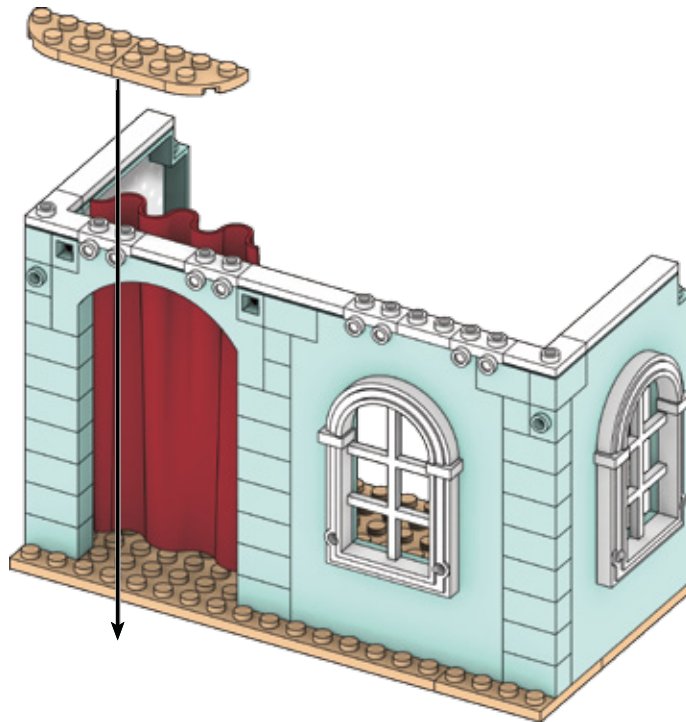



76



1x

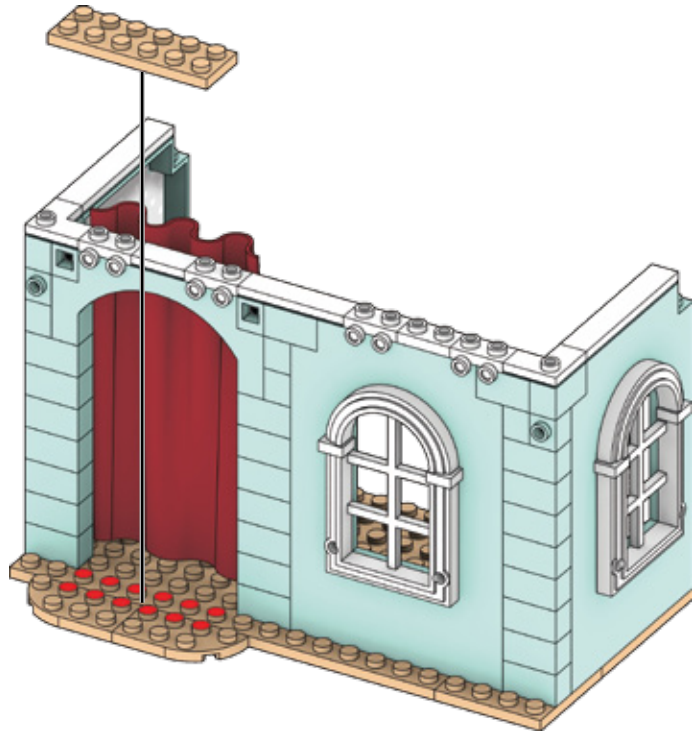

77



2x



6x



x2

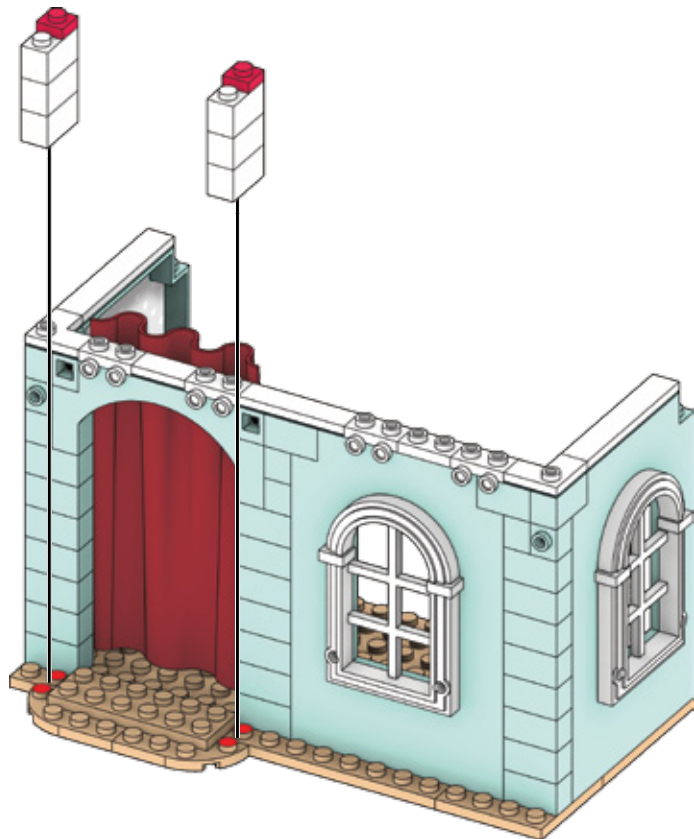



78



4x

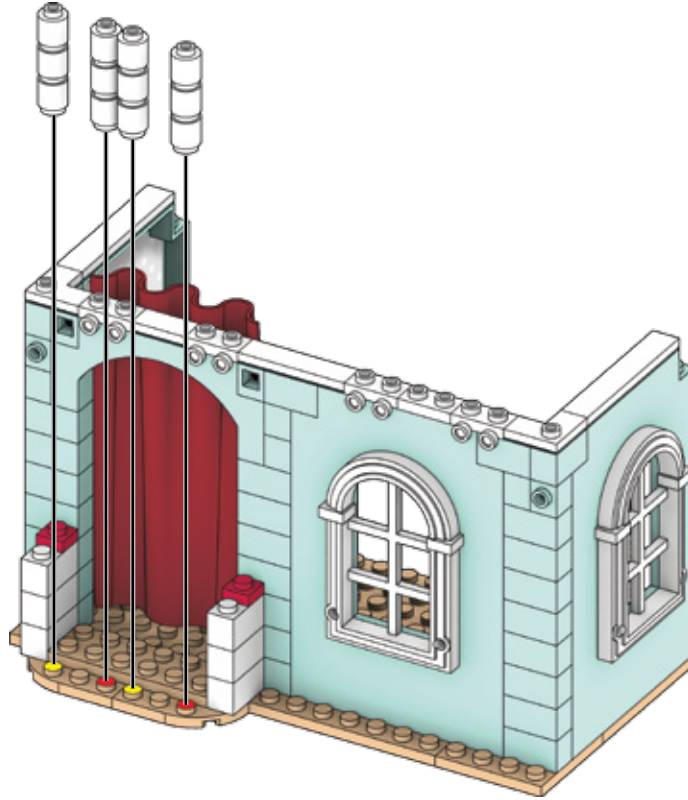

79



2x

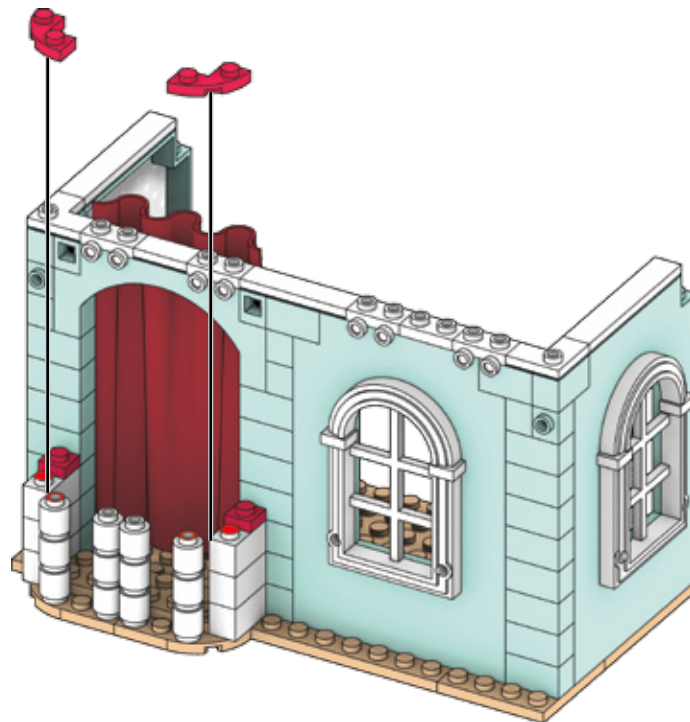



80



1x

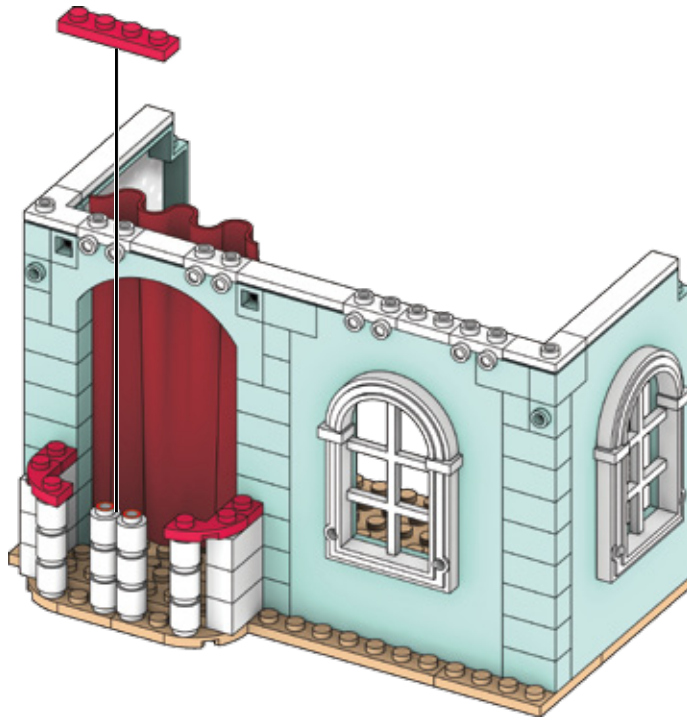

81



2x



2x

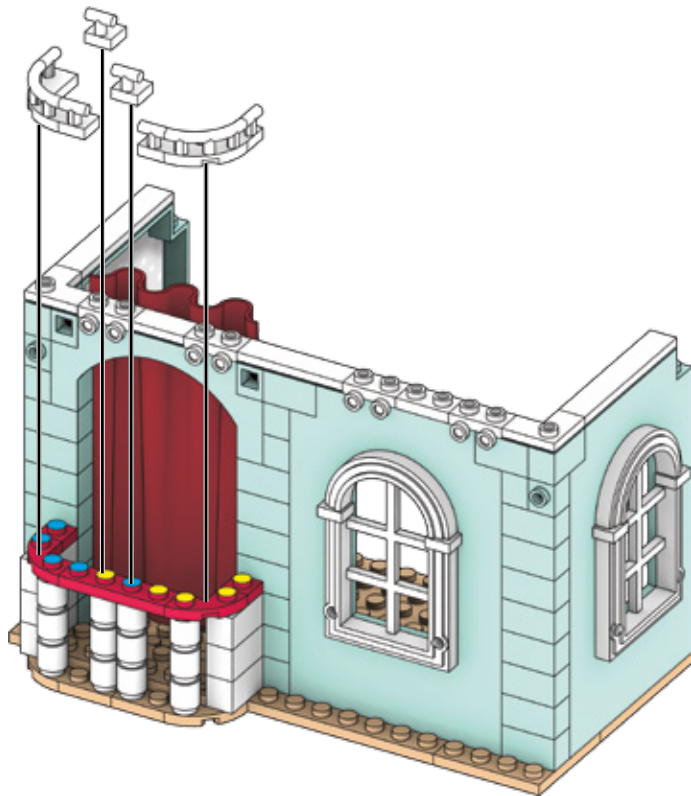



82



3x

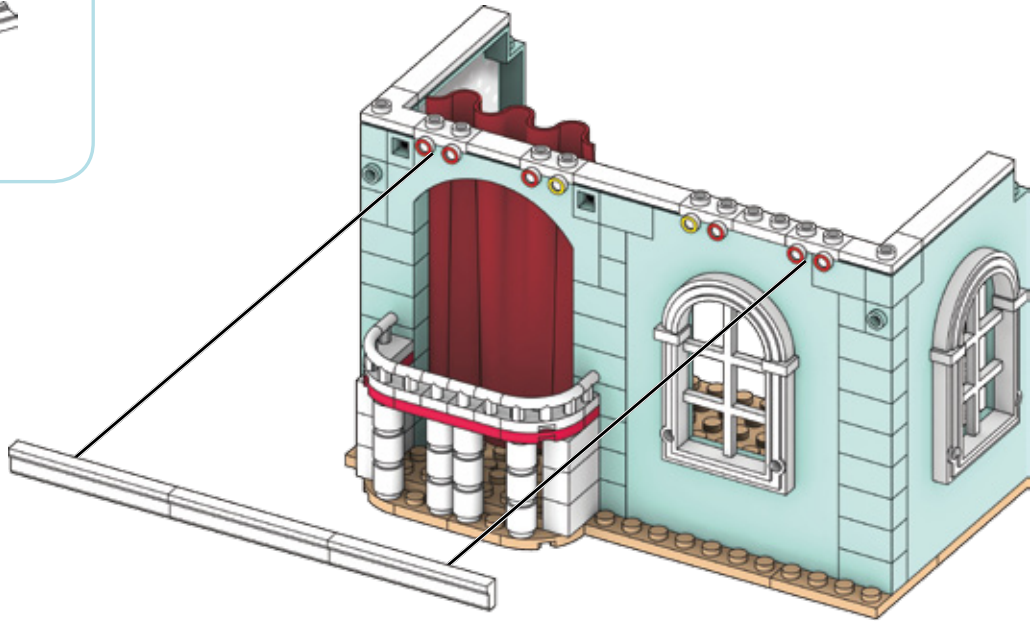

83



1x

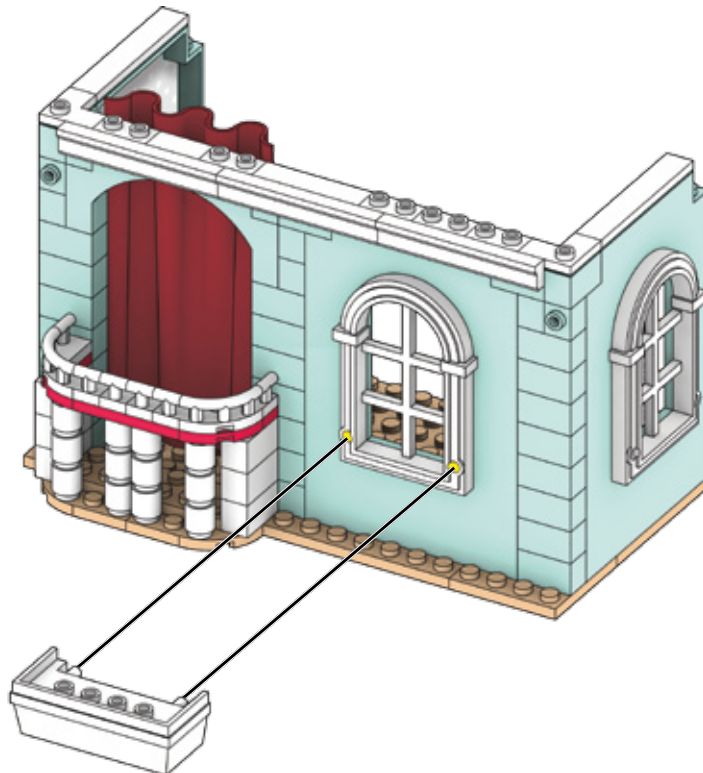



84



2x



2x



2x



x2

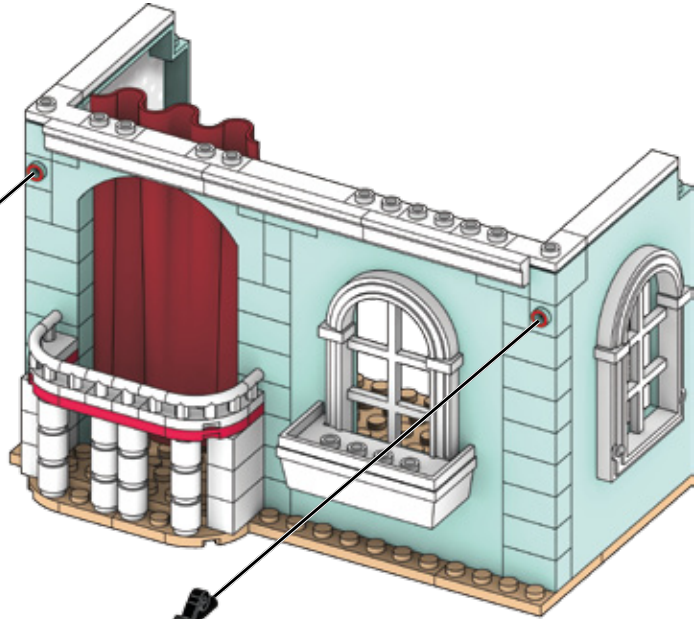

1

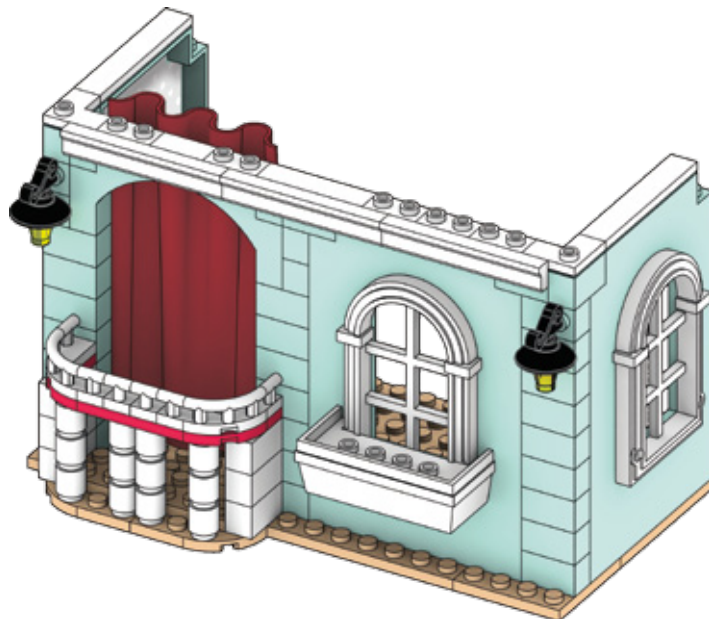

2



85



1x



1x



1x



1x



1x



1x



1x



1x



1



2



1



2



3



4

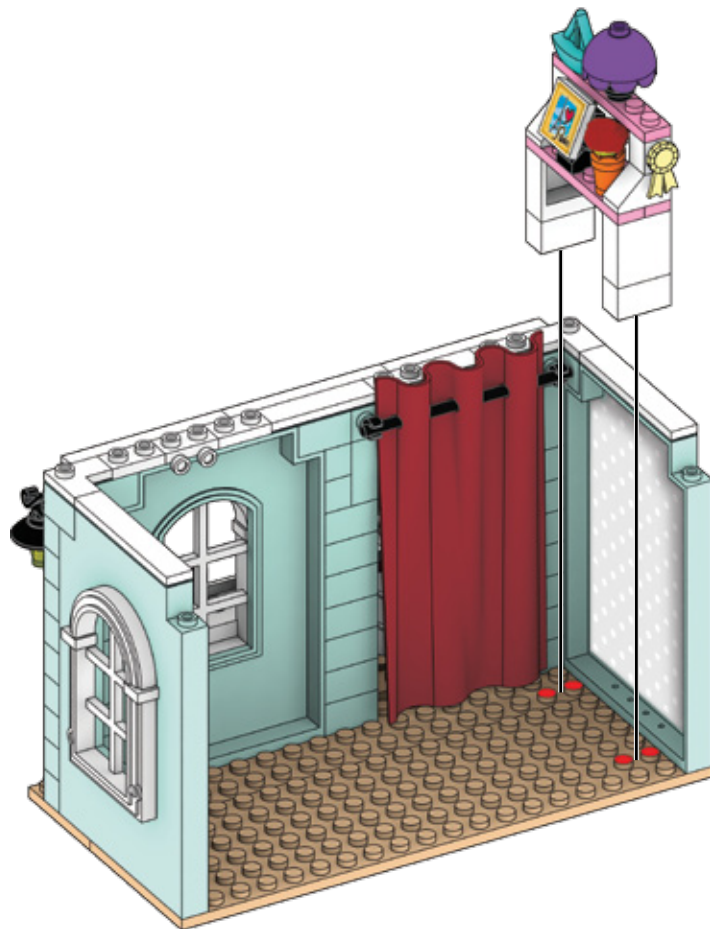



86

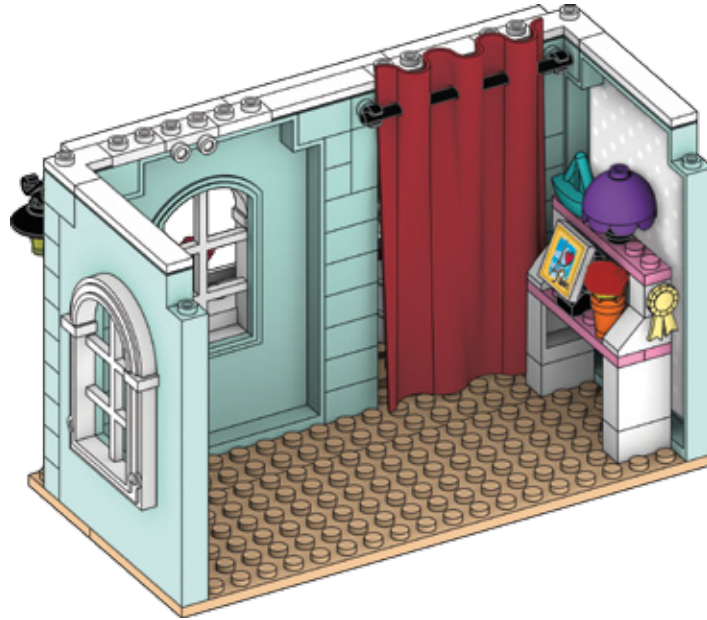

87



2x 2x

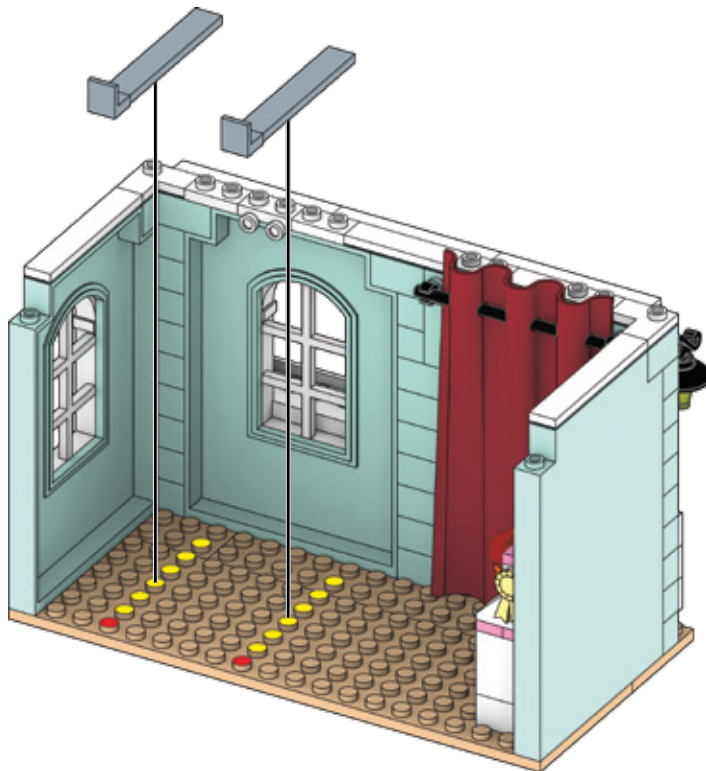



88



2x

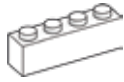

3x

Furniture
Guide
page 27
P

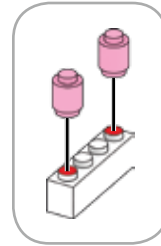
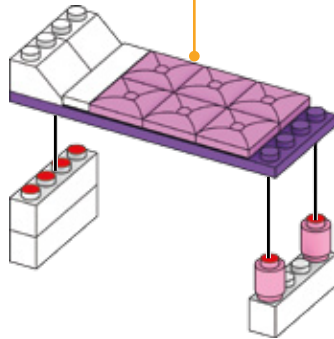
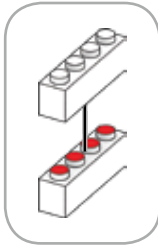

89



1x

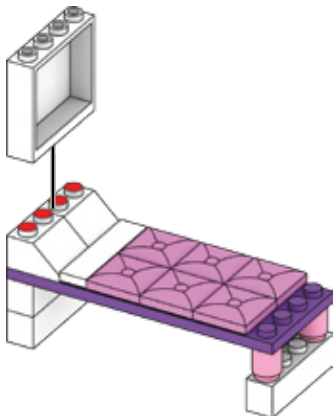

90



6x



3x

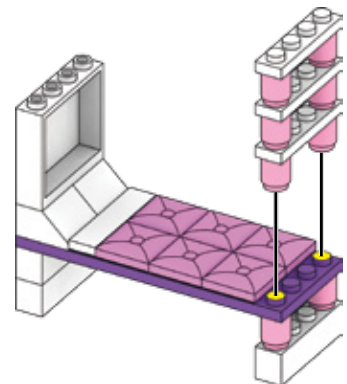
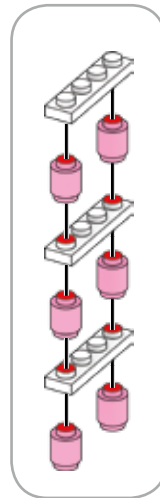



91

Furniture
Guide
page 27
P

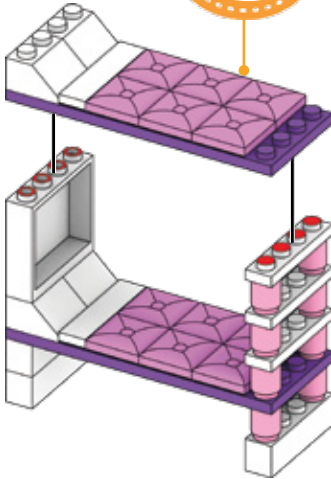

92



2x

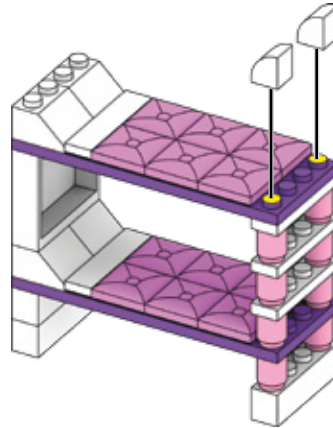

93

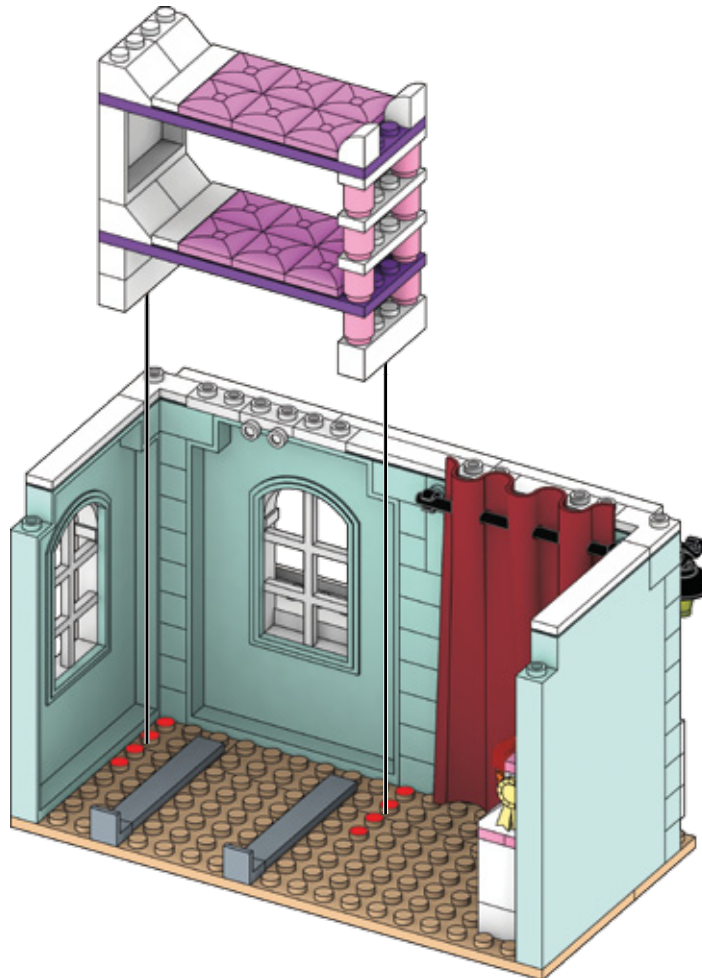



94

Furniture Guide
page 26
o

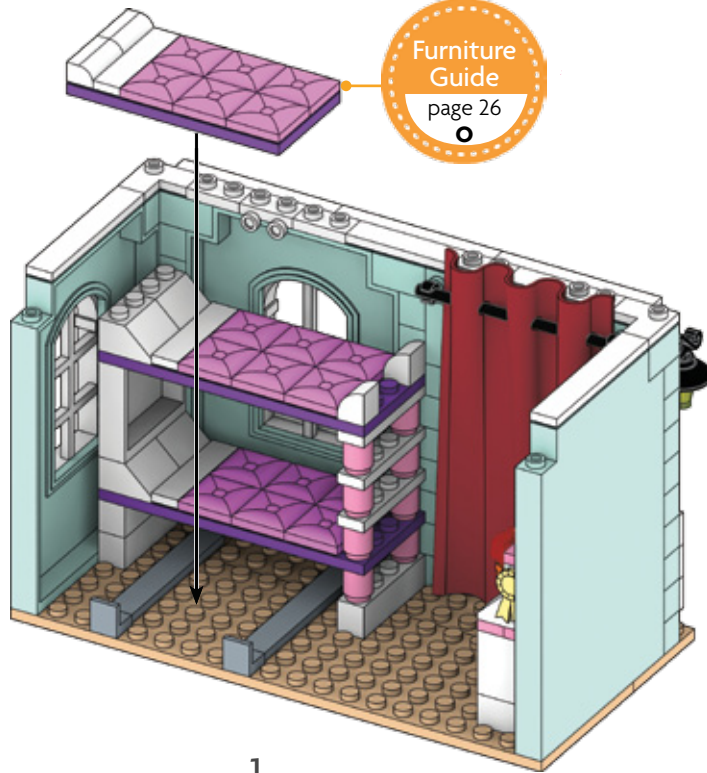

1

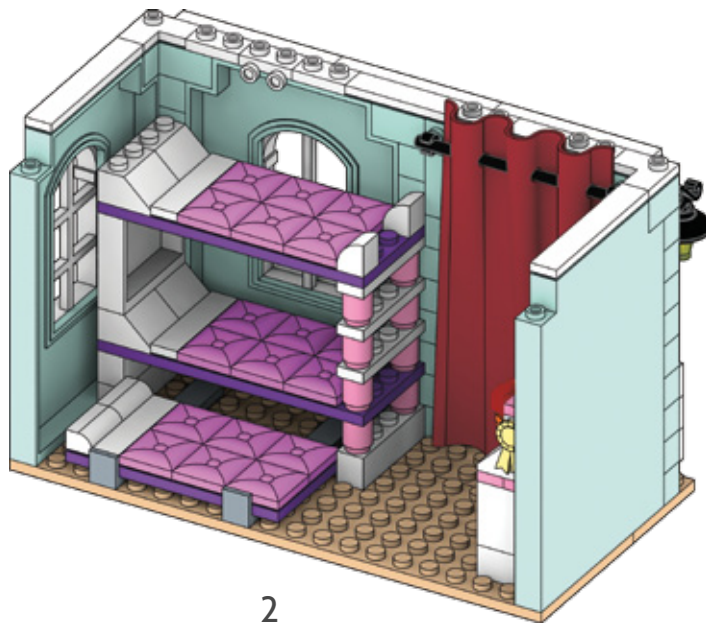

2



95

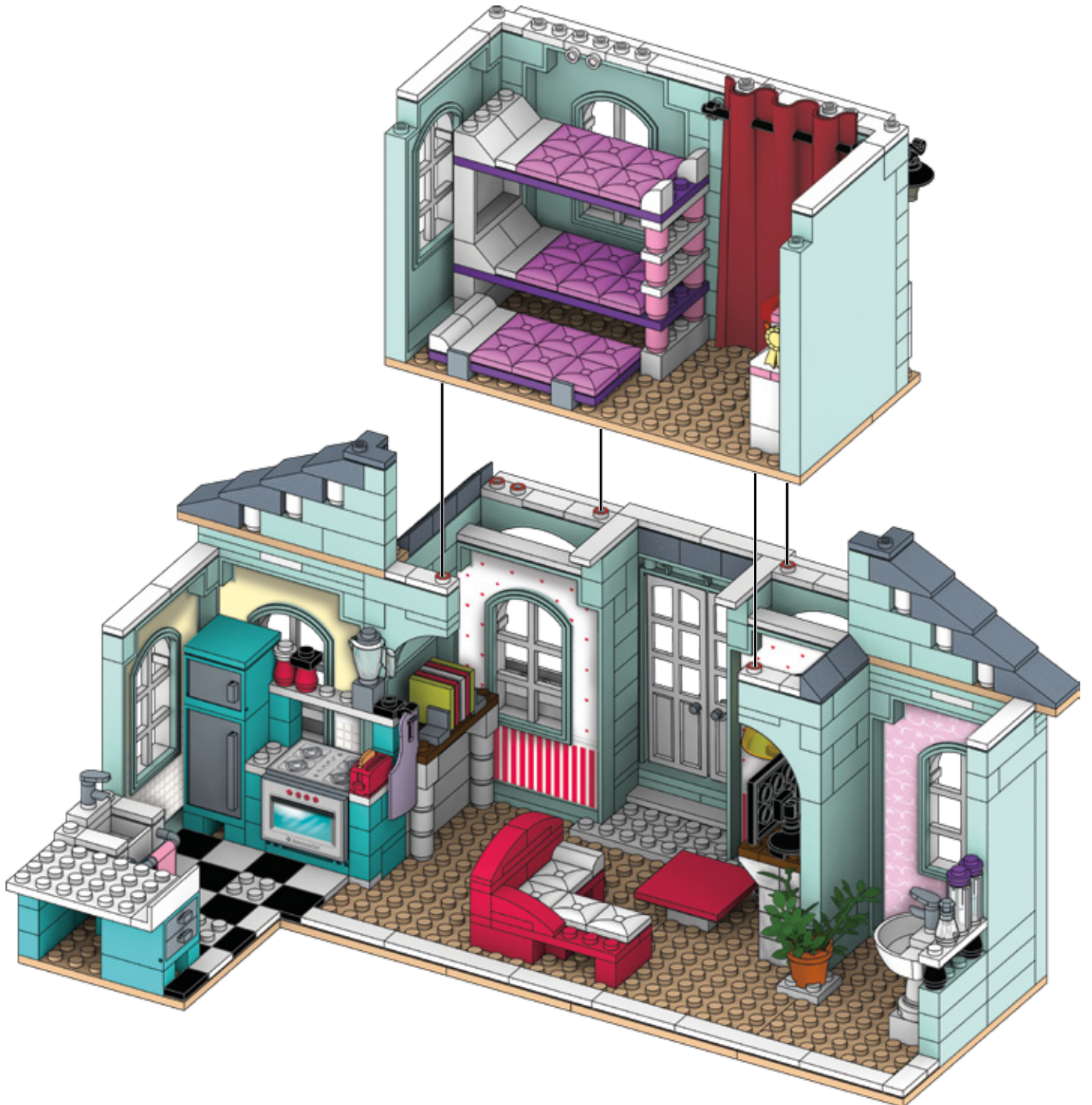



Next let's attach the roof to keep cozy!

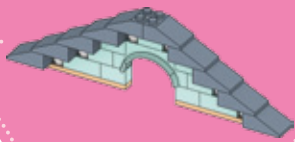

96

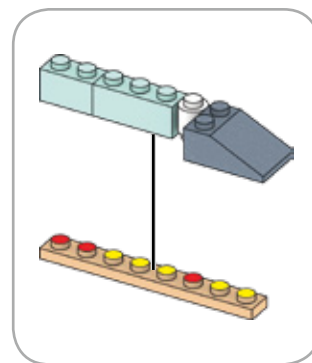
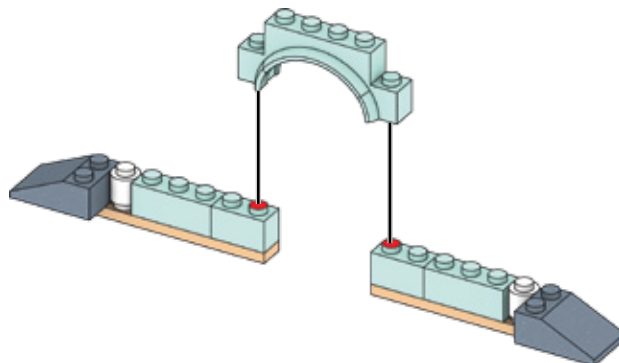
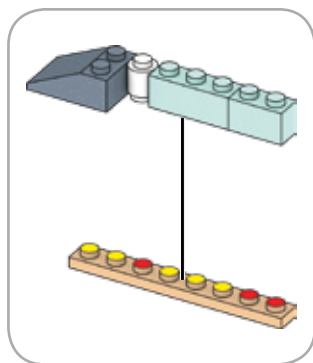
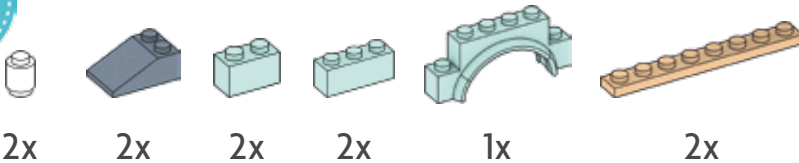

97

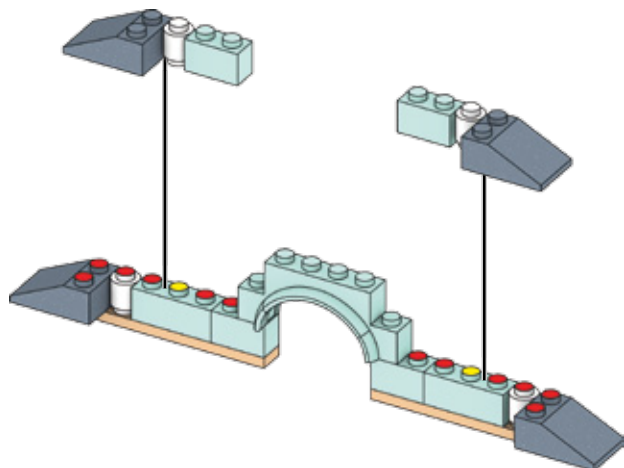
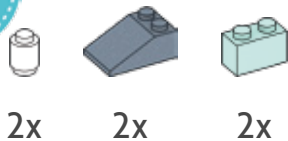

98

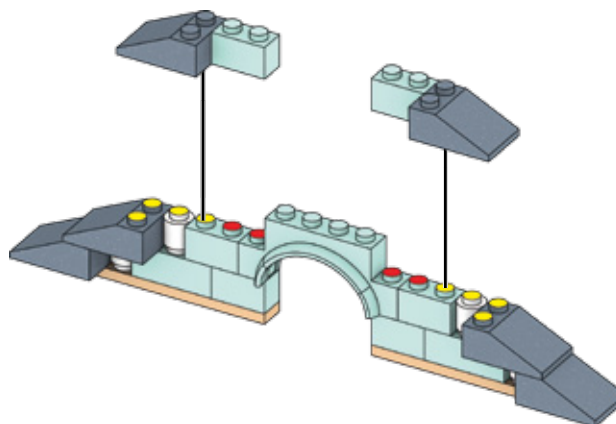
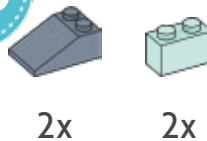



99



2x



2x



1x

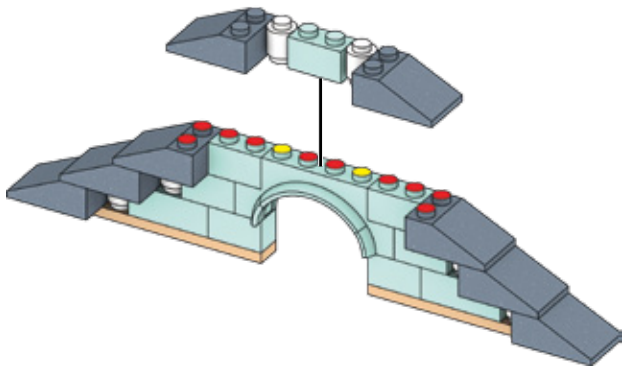

100



2x

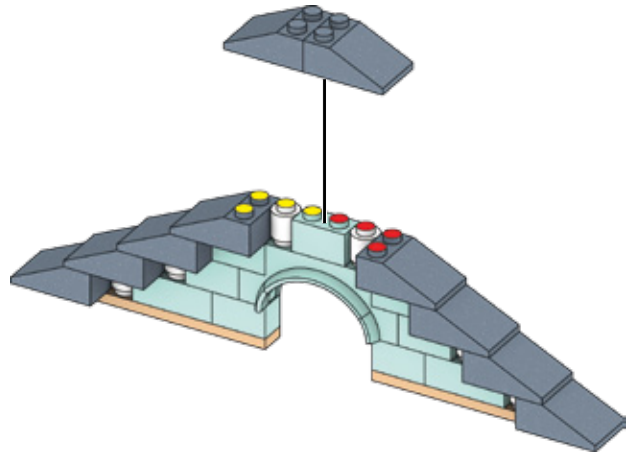

101

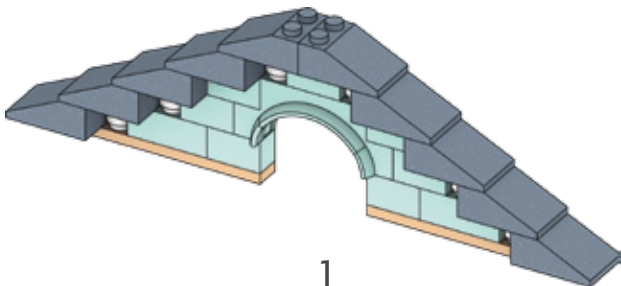

1

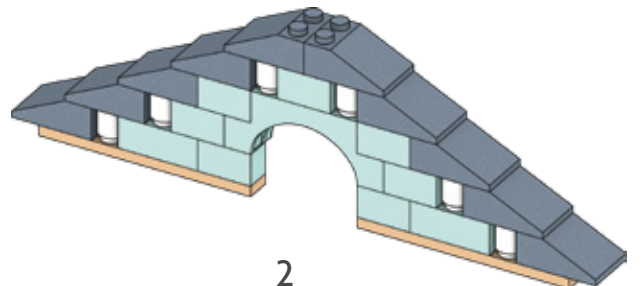

2



102

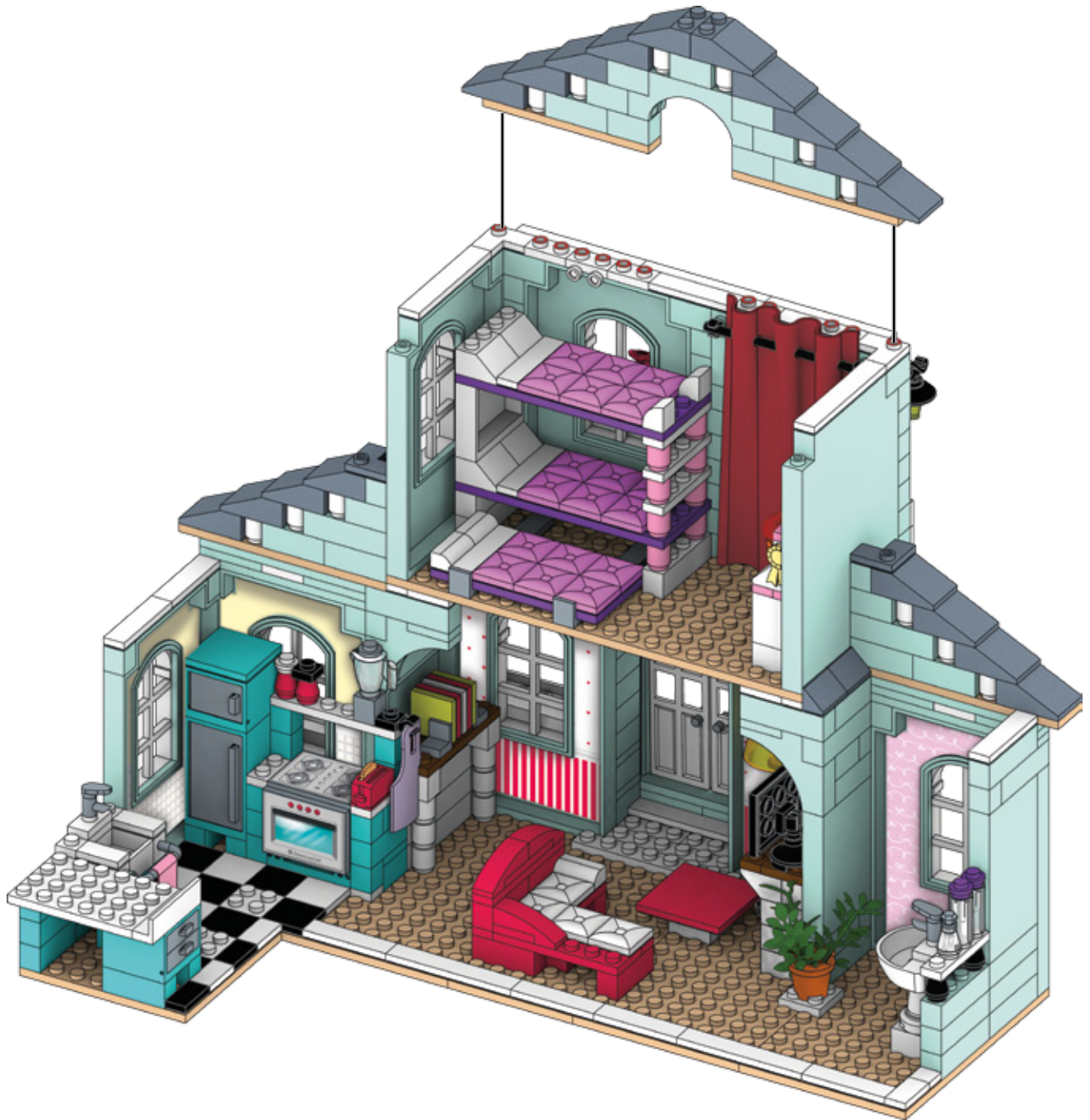



103



1x



1x





Grace Dreams Big

Grace loves to try new things, whether it's a new food, a new project, or moving to a new country. From her bedroom she can daydream about what she learned in Paris. Standing on her balcony she wonders, *Would a pretty view make her customers want to linger? Would customers here like an outdoor café? Hmmm...*





Let's step outside by building the patio!



105

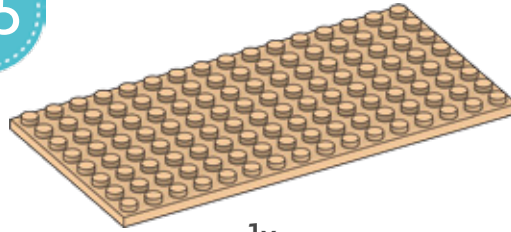

1x

Furniture Guide
page 30
S

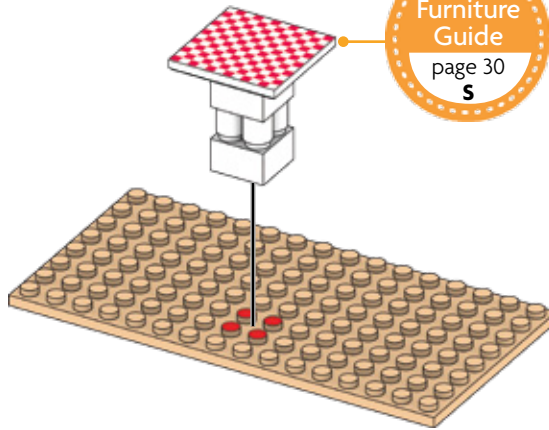

106



1x



2x

Furniture Guide
page 29
R

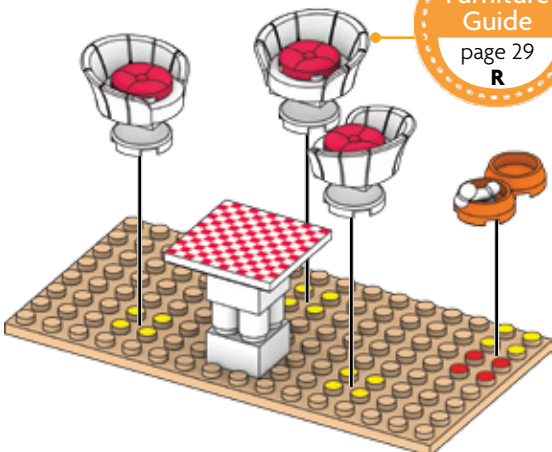

1

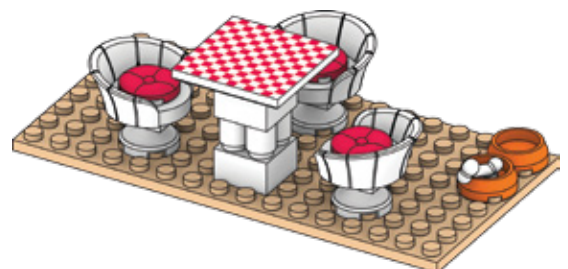

2



Add the finishing touches by building the accessories!



107

4x 4x 2x 2x



1x



1x



1x



3x

x4



x2





108



1x



1x



1x



1x



1x



1x



1x



1x



1x



1x



1x

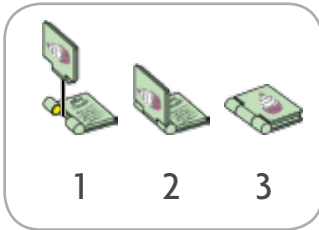
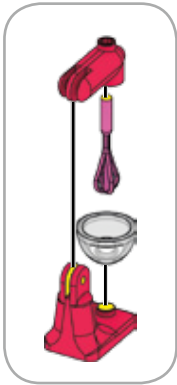

1

2

3





109



1x



1x



1x



1x



1x



1x



1



2



3



1



2



3





110



Bonbon the Puppy

Grace is thrilled when she gets to adopt a French bulldog puppy. She names her Bonbon, because the puppy looks tough on the outside, but inside she's all sweetness. Raising a puppy isn't easy, though. What mischief might Bonbon get into at Grace's house?





111

12x 4x

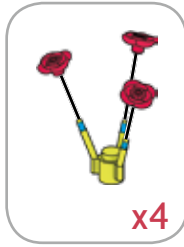

Furniture Guide
page 2
B







Congratulations!

You're all done building...
but the story is just beginning!

Now that you've built
Grace's Home, you can tell her
story your own way.
Recreate your favorite moments,
or build the next chapter in
Grace's tale!

Here are some ideas to get you started:

Grace loves the smell of cupcakes fresh from the oven—and so does her puppy! What happens when Bonbon sneaks into the kitchen and finds Grace's treats?

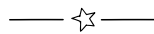

Grace wants to have the best sleepover ever for Ella's birthday. What do she and Maddie plan? Is it a surprise, and can they keep it a secret?

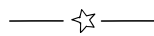

Could this be a vacation house where Grace's parents have taken Ella, Maddie, and Grace for the weekend? Where are they? What amazing views are outside their windows? Does Grace get any great ideas for how they should spend their time?



Be a story builder! Anything can happen when you're in charge. What other tales can you come up with?



ONE GIRL'S STORY.
MADE BY MANY.

You can create even more American Girl stories online.
Build the next chapter of your favorite story, or invent your own tales—
then share them! You can even discover what other girls have created.
Because together, we can build an even bigger story.



americangirl.megabloks.com

You can collect them all!

McKenna



DPK82

Grace



DPK83

Nicki



DPK85

Saige



DPK84

Isabelle



DPK86

Grace



DPK87

Each sold separately and subject to availability.

Please read these instructions carefully before first use and keep them for future reference.



WARNING:
CHOKING HAZARD. Small parts.
Not for children under 3 years.



Patent pending.
Brevet en instance. © D714, 887

© 2015, MEGA Brands Inc. &™ MEGA Brands Inc.; All American Girl marks are owned by and used under license from American Girl. All rights reserved.

© 2015, MEGA Brands Inc. ® &™ MEGA Brands Inc.
Printed in Canada D-DPK87-DOM03