

MEGA[™]
CONSTRUX

POKÉMON[™]



Build it!
Construis-Le!
¡constrúyelo!

LUXIO



WONDER
BUILDERS[™]

GMD36





Fuel their imagination with building toys that support creative thinking and problem solving.

Stimulez leur imagination avec des jouets de construction qui encouragent l'esprit créatif et la résolution de problèmes.

Alimenta su imaginación con juguetes de construcción que ayudan a desarrollar el pensamiento creativo y la resolución de problemas. Abasteça a imaginação dele com brinquedos de montar que suportam o pensamento criativo e a resolução de problemas.

Dieses Bauspielzeug beflügelt nicht nur die Phantasie, sondern unterstützt auch kreatives und lösungsorientiertes Denken.

Разжигайте воображение детей с помощью конструктора, развивающего творческие способности и логическое мышление.



Authentic details Détails authentiques

Detalles auténticos
Detalhes autênticos
Authentische Details
Реалистичные детали



Special pieces Pièces spéciales

Piezas especiales
Peças especiais
Spezielle Teile
Специальные детали

**Learn more
Pour en savoir plus**

Más información • Sabe mais
Weitere Infos gibt es auf • Узнать больше

play.megaconstrux.com



**MEGA
CONSTRUX**



Scan here for
instructions

Scanner ici
pour obtenir les
instructions

Escanee aquí para
obtener instrucciones

Digitalize aqui
para instruções

Hier scannen und
Anleitung aufrufen

Просканируйте здесь
для получения
инструкций



1



2

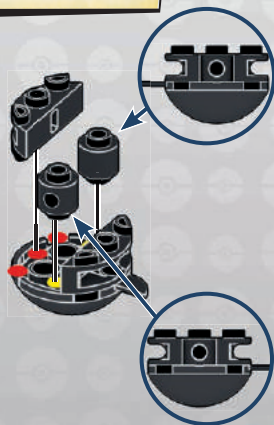

3



1x



1x

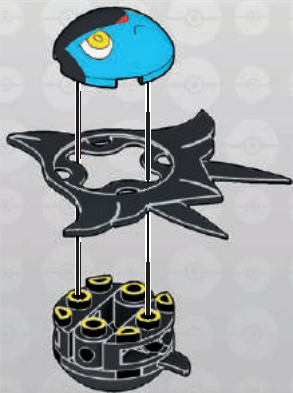

1



2

4



1x



1x

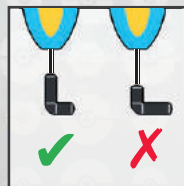

1



2

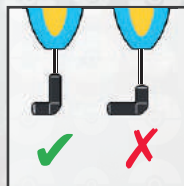
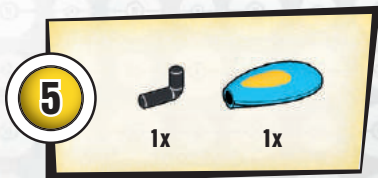

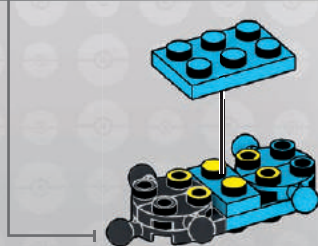
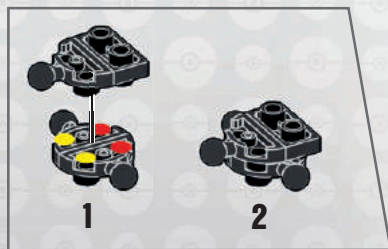
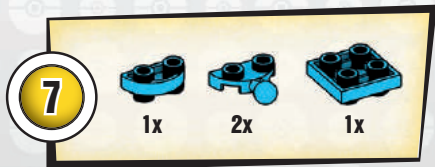

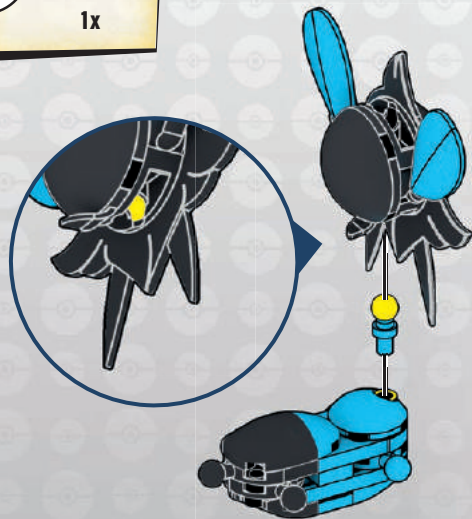
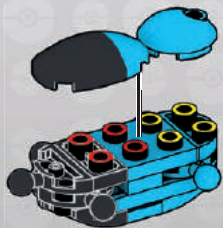

14



2x

2x

2x

2x

2x

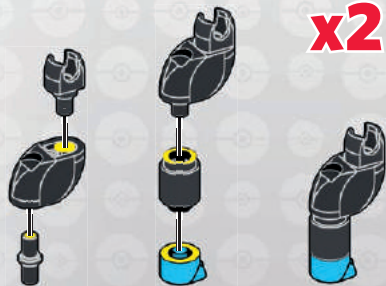

1

2

3

x2

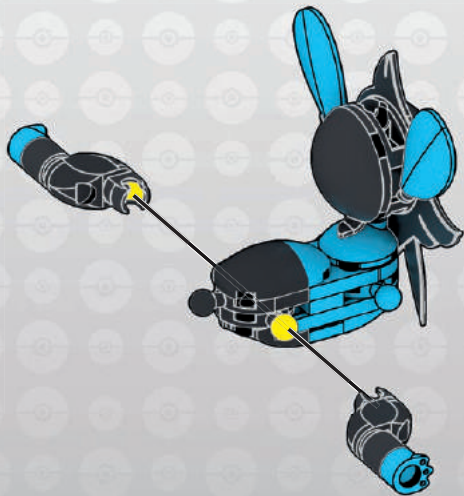

15



2x



2x



2x



1

x2



2

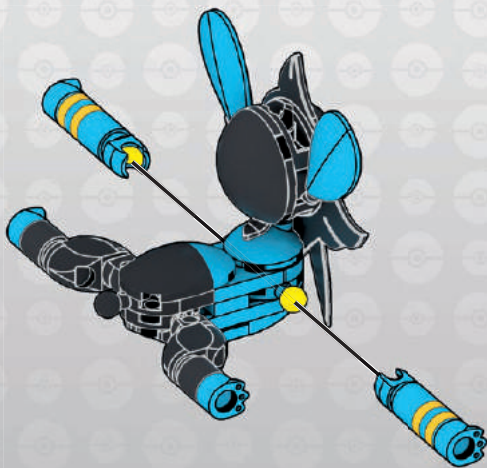

1

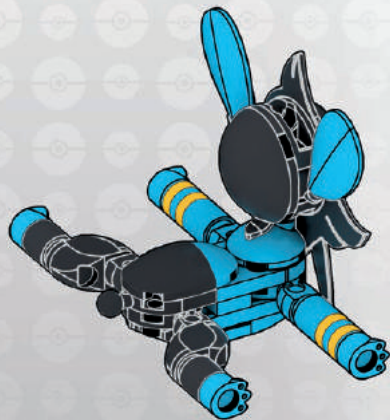

2



17



1x



1x



1x

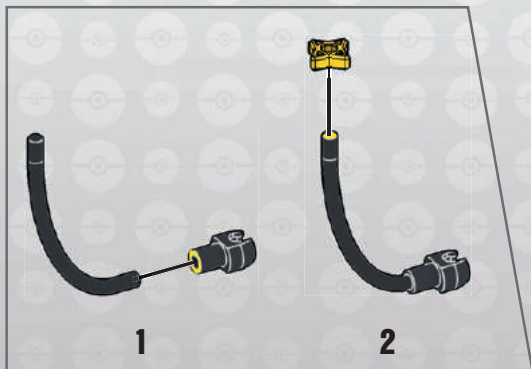



2



3

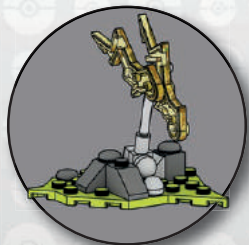

18

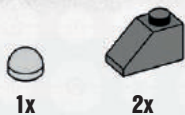

1x

2x

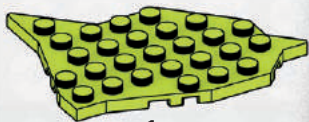

1x

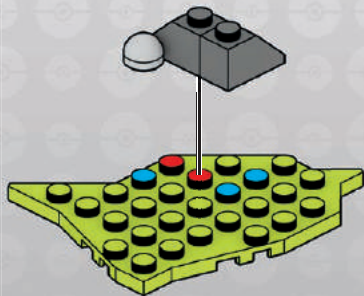

19

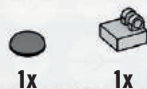

1x

1x

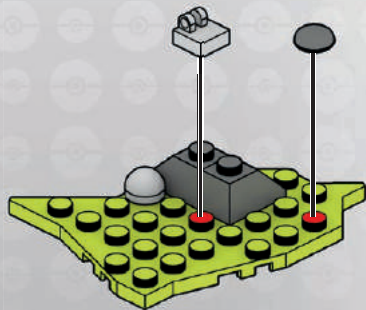

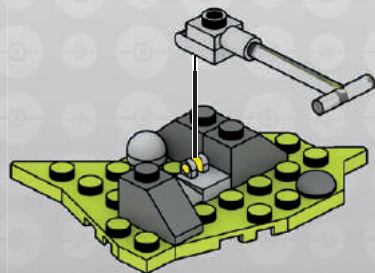
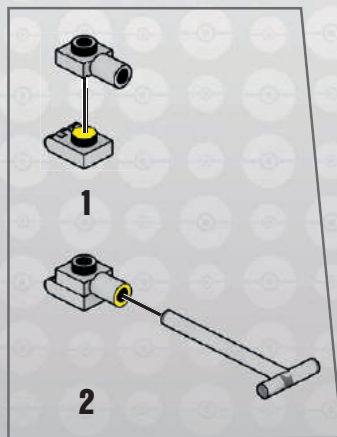
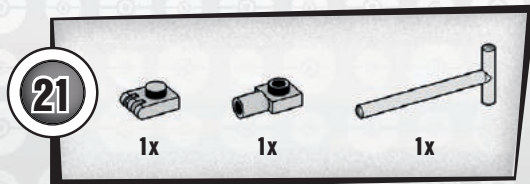
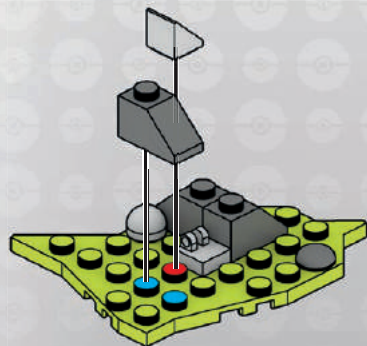
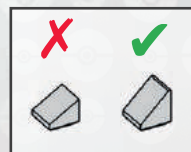
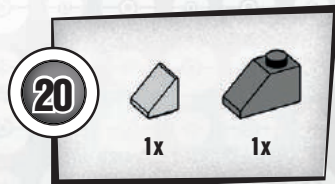

22

2x

1x

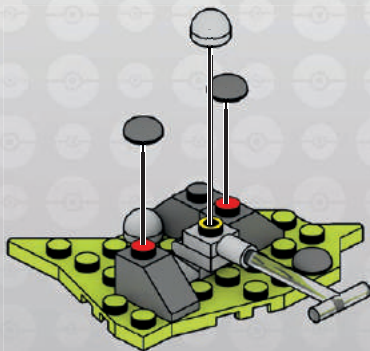

1

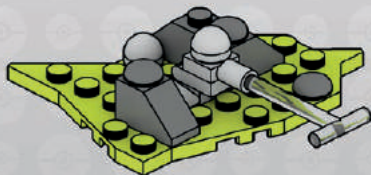

2

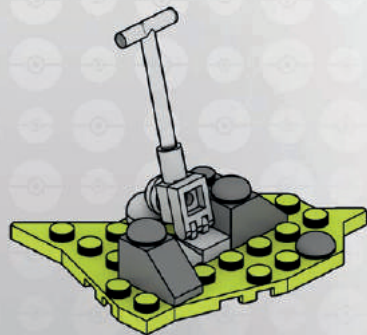

3

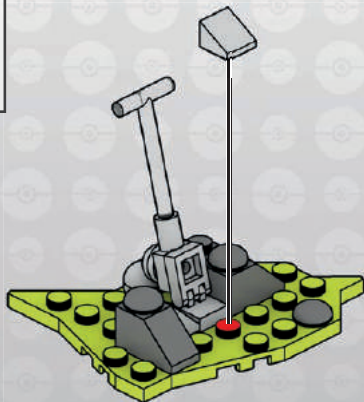
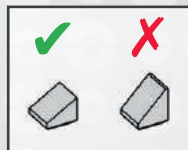
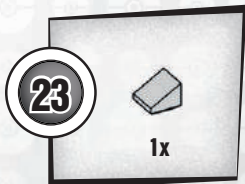

1

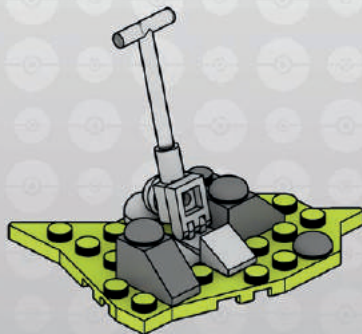

2

24



2x

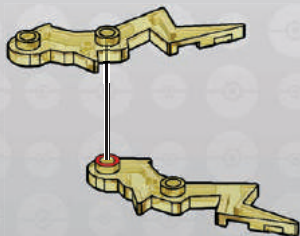

1



2

25

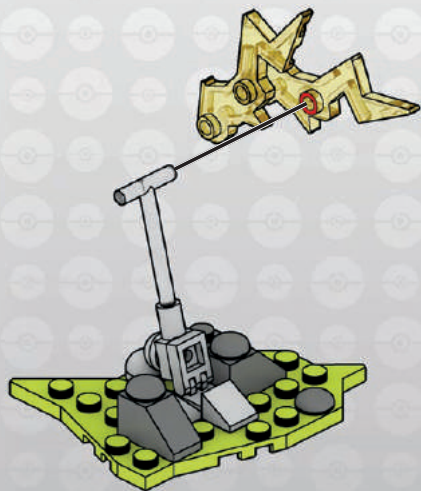

1

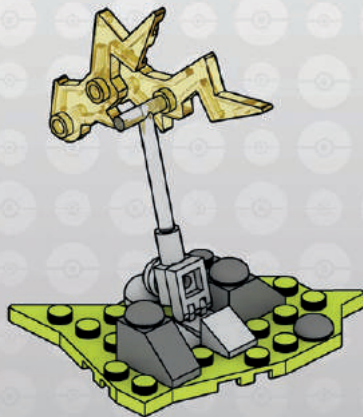

2



LUXIO





3x
AM75332BDG



1x
AM78632BYE



2x
AM78219BLG



1x
AM09104BLG



1x
MA17127BLG



2x
MA17003AYB



1x
AM80155AYB



4x
AM79988GD



2x
AM79487AYB



2x
AM80144AYB



2x
AS-GMD36-03



2x
MA19392AYB



1x
MA15258BLG



1x
AM78291GD



1x
AM09105BLG



1x
MA76058BLG



2x
AM78296AYB



2x
AM80485GD



1x
AM80485AYB



1x
MA022501GD



1x
MA09393GD



1x
MA16680AYB



1x
AM78391GD



2x
AM80145AYB



2x
AM80011GD



3x
AM80011AYB



1x
MA74427GD



1x
MA74427AYB



1x
MA74426GD



1x
MA74426AYB



1x
AM80754AYB



1x
AM79982GD



3x
MA1322BDG



1x
MA1146GD



1x
MA03772GD



2x
AM78282AYB



2x
AS-GMD36-02



1x
AS-GMD36-04



1x
AS-GMD36-01



1x
AM78287AYB



1x
AM72089W



2x
AM78389ZD



1x
AM79604AYB



1x
AM80753AYB



1x
MA73222BBG



Mattel Europa B.V., Gondel 1, 1186 MJ Amstelveen, Nederland. Mattel U.K. Limited, The Porter Building, 1 Brunel Way, Slough SL1 1FQ, UK. Mattel France, Parc de la Cerisaie, 1/3/5 allée des Fleurs, 94260 Fresnes Cedex. N° Cristal 0969 36 99 99 (Numéro non surtaxé) ou www.lesjouetsmattel.fr Mattel Belgium, Trade Mart, Atomiumsquare, Bogota 202 – B 275, 1020 Brussels. Gratis nummer België: 0800 – 16 936 - Gratis nummer Luxemburg: 800 – 22 784 - Gratis nummer Nederland: 0800 - 262 88 35. Deutschland : Mattel GmbH, Solmsstraße 4, D-60486 Frankfurt am Main. Schweiz: Mattel AG, Kirchstrasse 24, CH-3097 Liebfeld. Österreich: Mattel Ges.m.b.H., Campus 21, Liebermannstraße A01 404, A- 2345 Brunn/Gebrige. Mattel Italy Srl, Via Bracco, 6-MAC 6, 20159 Milano, Italy. Servizio assistenza clienti: Customerserv.italia@mattel.com - Numero verde 800 11 37 11. Mattel España, S.A., Aribau 200. 08036 Barcelona. cservice.spain@mattel.com Tel: 902203010 http://www.service.mattel.com/es. Mattel East Asia Ltd., Room 503-09, North Tower, World Finance Centre, Harbour City, Tsimshatsui, HK, China. Tel: (852) 3185-6500. Diimport & Diedarkan Oleh: Mattel Continental Asia Sdn Bhd. Level 19, Tower 3, Avenue 7, No. 8 Jalan Kerinci, Bangsar South, 59200 Kuala Lumpur, Malaysia. Mattel South Africa (PTY) LTD, Office 102 13, 30 Melrose Boulevard, Johannesburg 2196. Dystrybutor: Mattel Poland Sp. z o.o., Warsaw Trade Tower 34 p., ul. Chlodna 51, 00-867 Warszawa. Mattel Australia Pty. Ltd., 658 Church St., Richmond, Victoria, 3121. Consumer Advisory Service - 1300 135 312. Mattel AEBE, Εβνδούρου Μακρορίου 1, Κτήριο Κ-2, ΤΚ 17561, Παλαιό Φάληρο. Mattel Oyuncakçılık Tic. Ltd. Şti. İcerenköy Mah., Erkut Sok. A Blok No:12 Üner Plaza Kat:9-10 34752 Ataşehir İstanbul. Tel: 0216 570 75 00. Импортёр/Уполномоченная организация: ООО "МАТТЕЛ" Российская Федерация, 105120 Москва, 2-й Сыромятинский переулок, 1; +7 495 287 79 39. Forg.: Mattel Toys Hungary Kft 1139 Budapest Váci út 91. +36 1 270 0223. Mattel Czech Republic s.r.o., The Forum, Vláclavské nám. 19, 11000 Praha 1. Mattel, Inc. 636 Girard Avenue, East Aurora, NY 14052, U.S.A. Mattel Canada Inc., Mississauga, Ontario L5R 3W2. Consumer Services: You may call us free at/Composez sans frais le 1-800-524-8697. Importado y distribuido por Mattel de México, S.A. de C.V., Miguel de Cervantes Saavedra No. 193, Pisos 10 y 11, Col. Granada, Alcaaldia Miguel Hidalgo, C.P. 11520, México, Ciudad de México. R.F.C. MME-920701-NB3. Tels.: 59-05-51-00 Ext. 5206 ó 01-800-463-59-89. Mattel Chile, S.A., Avenida Américo Vespucio 501-B, Quilicura, Santiago. Tel.: 1230-020-6213. Servicio al consumidor Venezuela: 01-800-100-9123. Mattel Argentina, S.A., Av. Libertador 1000, Piso 11 – Oficinas 109 y 111, Vicente López – Prov. Buenos Aires. Tel.: 0800-666-3373. Mattel Colombia, S.A., Calle 123#7-07 P5, Bogotá. Tel.: 01800-710-2069. Mattel Perú, S.A., Av. Juan de Arona # 151, Centro Empresarial Juan de Arona, Torre C, Piso 7, Oficina 704, San Isidro, Lima 27, Perú. RUC: 20425853865. Reg. Importador: 02350-12 JUE-DIGESA. Tel.: 0800-54744. E-mail Latinoamérica: servicio.clientes@mattel.com. Mattel do Brasil Ltda.- CNPJ: 54.558.002/0001-20 - Rua Verbo Divino, 1488 - 2º. Andar - 04719-904 - Chácara Santo Antônio - São Paulo - SP - Brasil. Serviço de Atendimento ao Consumidor: fone 0800-550780. E-mail: sac.matteldobrazil@mattel.com

P D799,608, D834,105

⚠ WARNING:
CHOKING HAZARD. - Small parts.
Not for children under 3 years.

⚠ ATTENTION:
DANGER D'ÉTOUFFEMENT. - Présence de petits éléments.
Ne convient pas aux enfants de moins de 3 ans.

⚠ 警告:
のどにつまる危険 小さな部品が含まれています
3歳以下の子供には与えないで下さい。

تذير:
غير مناسبة للأطفال دون 36 شهراً - قطع صغيرة.

⚠ 警告!
不适合3岁以下儿童使用。
内含小零件。

ADVERTENCIA: PELIGRO DE ATRAGANTAMIENTO. Juguete no recomendado para menores de 3 años, porque contiene piezas pequeñas que podrían provocar asfixia en caso de ser ingeridas o inhaladas por el/la niño/a.

ATENÇÃO! NÃO INDICADO / NÃO RECOMENDÁVEL PARA CRIANÇAS MENORES DE 3 (TRÊS) ANOS POR CONTER PARTE(S) PEQUENA(S) QUE PODE(M) SER ENGOLIDA(S) OU ASPIRADA(S) PODENDO PROVOCAR ASFIXIA.

AVVERTENZA: Contiene pezzi di piccole dimensioni.

ACHTUNG: Kleine Teile.

OSTRZEŻENIE: Małe części. Niebezpieczeństwo zadławienia.

WAARSCHUWING: Kleine onderdelen

ПРЕДУПРЕЖДЕНИЕ: Мелкие детали.

ADVARSSEL: Indeholder små dele.

WARNING: Smådelar

ADVARSSEL: Små deler

VAROITUS: Pieniä osia

ΠΡΟΣΟΧΗ: Περιλαμβάνονται μικρά κομμάτια.

UYARI: Küçük parçalar.

UPOZORNENÍ: Malé díly

UPOZORNENIE: Malé časti

FIGYELMEZTETÉS: Kis alkatrészek.



©2020 The Pokémon Company International. ©1995–2020 Nintendo / Creatures Inc. / GAME FREAK inc. TM, ®, and character names are trademarks of Nintendo.

© 2020 The Pokémon Company International.
© 1995–2020 Nintendo/Creatures Inc./GAME FREAK inc. TM, ®
et les noms des personnages sont des marques de Nintendo.



MEGA
CONSTRUX

POKÉMON

MORE TO BUILD!
ENCORE PLUS À CONSTRUIRE !
¡MÁS PARA CONSTRUIR!
MAIS PARA CONSTRUIR!
MEHR ZUM BAUEN!
СОБЕРИ ИХ ВСЕХ!



GKY86



GMD31



GKY87

Each sold separately and subject to availability. / Produits vendus séparément, selon la disponibilité. / Se venden por separado y están sujetos a disponibilidad. / Vendidos em separado e sujeitos à disponibilidade. / Ognuno in vendita separatamente secondo disponibilità. / Alle Artikel separat erhältlich. Einige Artikel werden nicht in allen Ländern vertrieben. / Sprzedawane oddzielnie w zależności od dostępności. / Per stuk verkrijgbaar en niet overal leverbaar. / Каждый продукт продается отдельно, в зависимости от наличия. / Sælges separat og så længe lager haves. / Alla delar säljs separat så långt lagret räcker. / Hver leke selges separat så langt lagret rekker. / Jokainen myydään erikseen, saatavuus voi vaihdella. / Το καθένα πωλείται ξεχωριστά και ανάλογα με τη διαθεσιμότητα. / Her biri ayrı ayrı ve stoklara bağlı olarak satılır. / Každá hračka se prodává samostatně dle aktuální nabídky. / Každé sa predáva samostatne a podľa dostupnosti. / Mindegyik külön kapható, elérhetőségük változhat. / それぞれ在庫状況に従って個別に販売されます。 / تباع كل منها على حدة وتخضع لتوفره.

每件单独出售，并且视库存情况而定。

1186 MJ, 1, NL

©2020, MEGA Brands Inc. &™ MEGA Brands Inc.
CONSTRUX™ is owned by Mattel and used under license.
CONSTRUX™ appartient à Mattel et est utilisé sous
licence. Printed in Canada / Imprimé au Canada
D-GMD36-01

MEGA Brands Inc. Montreal QC H4T 1K4 Canada

MADE IN CANADA WITH DOMESTIC AND IMPORTED COMPONENTS. FABRIQUÉ AU CANADA AVEC
DES COMPOSANTS DOMESTIQUES ET IMPORTÉS. FABRICADO NO CANADÁ COM
COMPONENTES CANADIANOS E IMPORTADOS. FABRICADO EN CANADÁ CON PIEZAS
FABRICADAS EN CANADÁ Y PIEZAS IMPORTADAS. ИЗГОТОВЛЕНО В КАНАДЕ С
ОТЕЧЕСТВЕННЫМИ И ИМПОРТНЫМИ КОМПОНЕНТАМИ. YERLİ VE İTHAL PARÇALARLA
KANADA'DA ÜRETİLMİŞTİR. صنع في كندا من مواد محلية ومستوردة.

Are you ready for the
next challenge?

Prêt pour le
prochain défi ?

¿Estás listo para el
siguiente desafío?

Você está pronto para o
próximo desafio?

Bist du bereit für die
nächste Herausforderung?

Вы готовы к
следующему испытанию?

10+
PRO
BUILDERS



MIX
Paper from responsible sources
Papier Issu de sources responsables
FSC® C011825