

MEGA
CONSTRUX

HALO

HALO
INFINITE

GYG59



2 in 1*
EM / B



**PRO
BUILDERS™**

*Instructions included for main model only. Other build(s) can be found at megaconstrux.com / Instructions incluses pour le modèle principal uniquement.
Les instructions pour l'(les) autre(s) modèle(s) de construction se trouvent sur le site megaconstrux.com



Scan here for
instructions

Scanner ici pour
obtenir les instructions

Escanee aquí para obtener instrucciones
Digitalize aquí para instruções
Hier scannen und Anleitung aufrufen
Просканируйте здесь для получения инструкций

megaconstrux.com

Choose your Build
Choisissez votre construction

Elije tu armado • Escolha sua montagem
Wähle dein Modell • Выбери свою конструкцию



Most models can be built one at a time. / La plupart des modèles peuvent être construits un à la fois. / La mayoría de modelos se pueden construir de uno en uno. / A maioria dos modelos pode ser construída separadamente. / La maggior parte dei modelli possono essere realizzati uno per volta. / Die meisten Modelle können eines nach dem anderen gebaut werden. / Większości modeli nie da się budować jednocześnie z innymi. / De meeste modellen kunnen één voor één gebouwd worden. / Большинство моделей могут быть собраны по одной за раз. / De fleste modeller kan bygges enkeltvis. / De flesta modeller kan byggas en i taget. / De fleste modellene kan bygges en om gangen. / Useimmat mallit voidaan rakentaa yksi kerrallaan. / Τα περισσότερα μοντέλα μπορούν να κατασκευασθούν ένα ένα. / Modellerin çoğu ayrı ayrı inşa edilmeyi gerektirebilir. / Většinou lze najednou sestavit pouze jeden model. / Väčšina modelov môže byť zostavená iba raz. / A modellek többségéből egyszerre csak egy építhető. / ほとんどのモデルは、一度に一つを組み立てることができます。 / يمكن تركيب التصميم الواحد تلو الآخر.

大多數型號可一次性建構

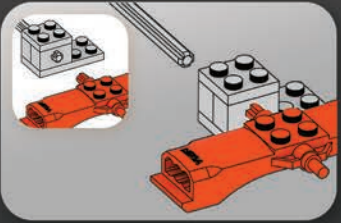
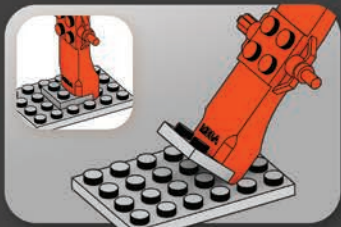

Building Tool Outil de construction

Herramienta de construcción
Bauwerkzeug
Ferramenta de montagem
Инструмент для конструирования

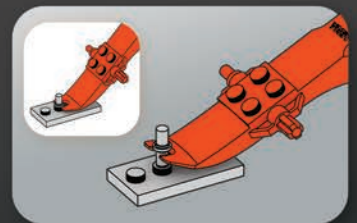
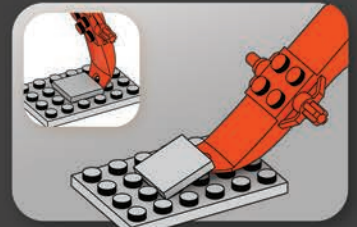

1

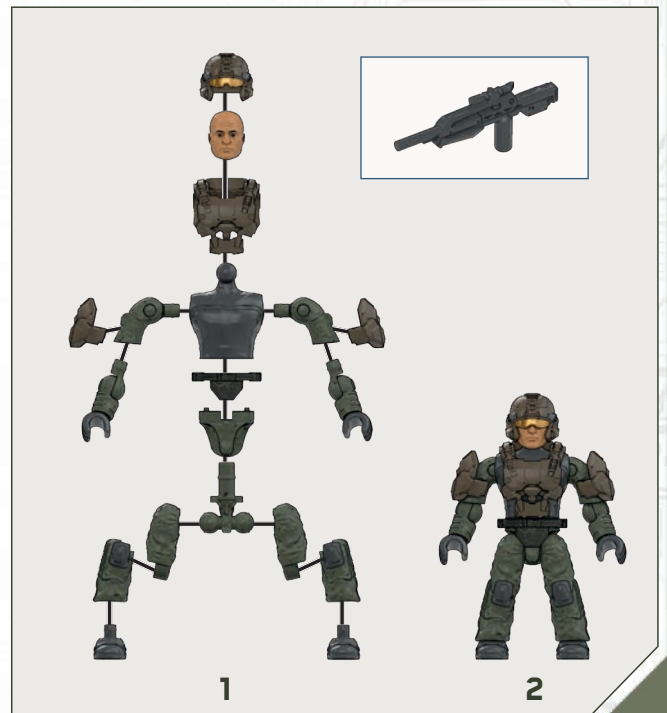
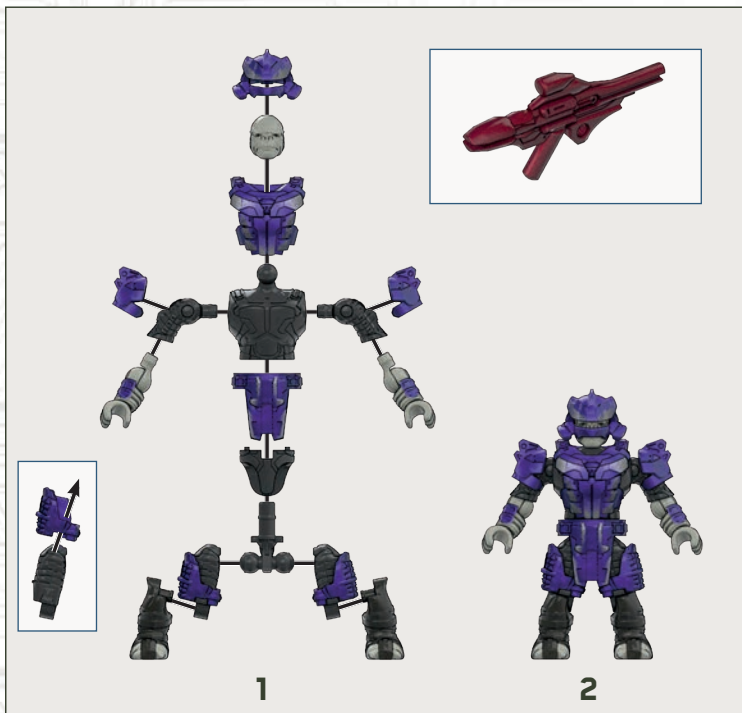



1



2



1



2

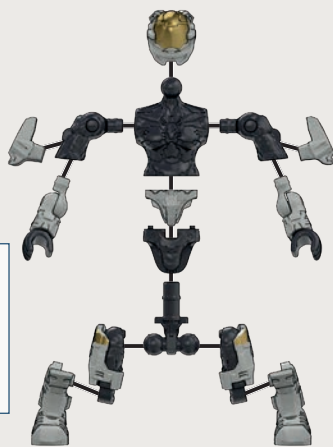
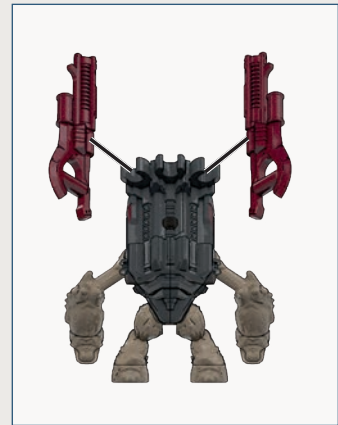

1

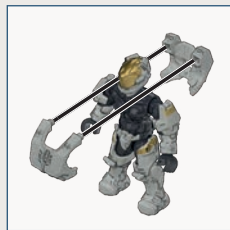

2



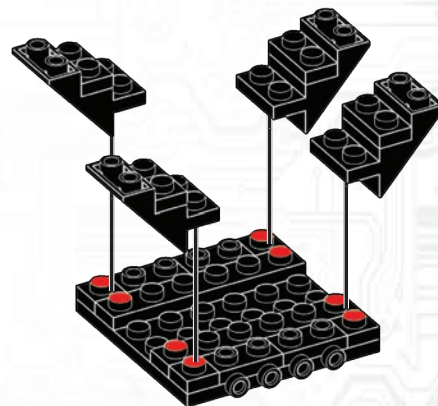
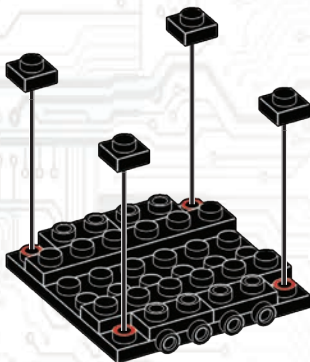
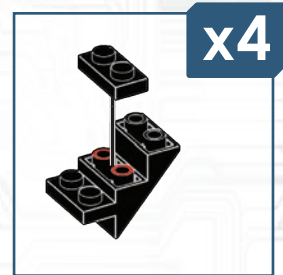
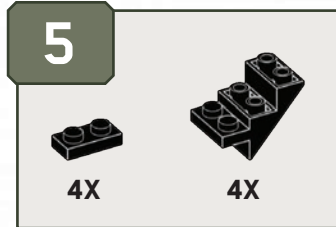
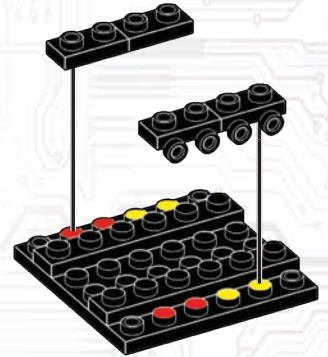
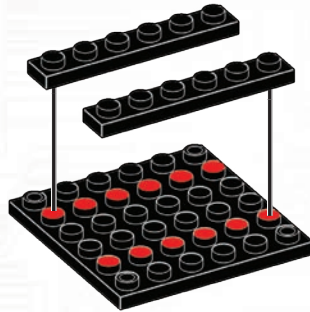
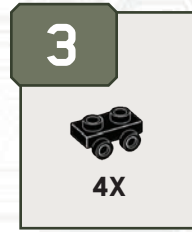
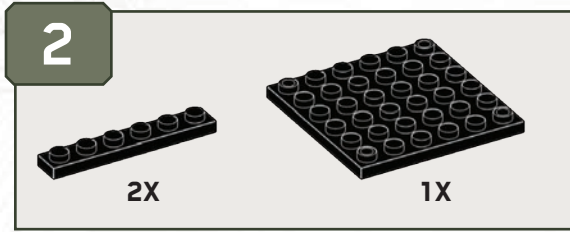

6



2X

7

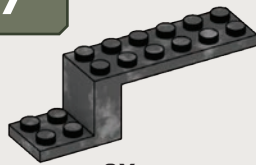

2X

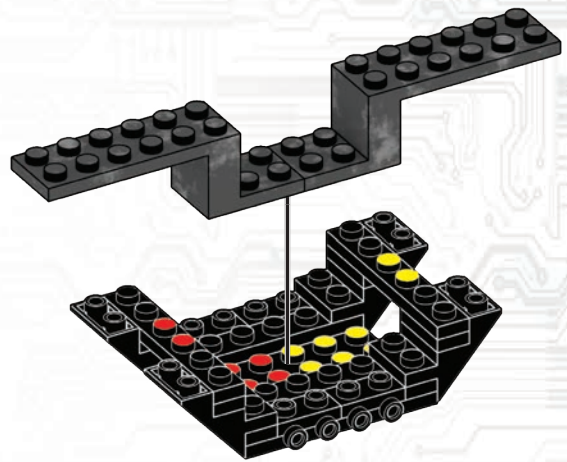
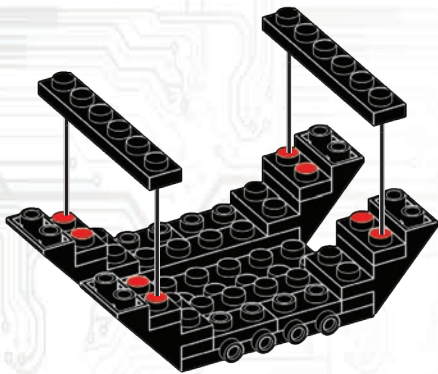

8



1X



1X

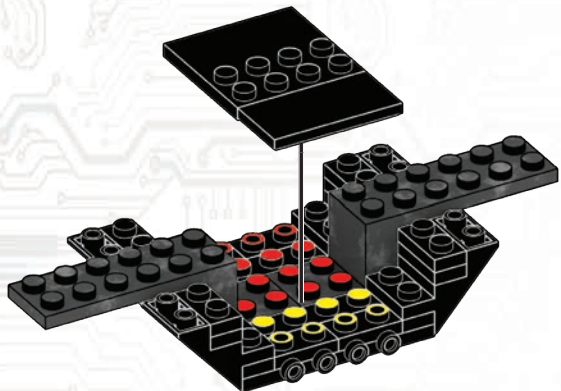

1

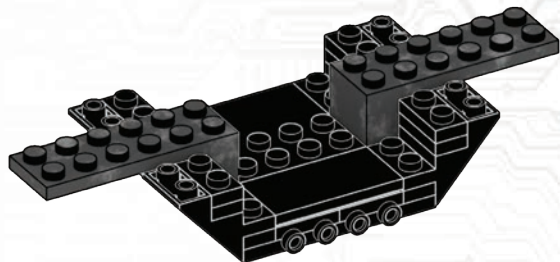

2

9

1X 1X

1X



10

1X 1X 1X 1X

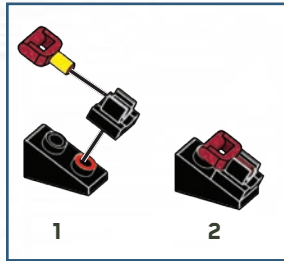

11

1X



12

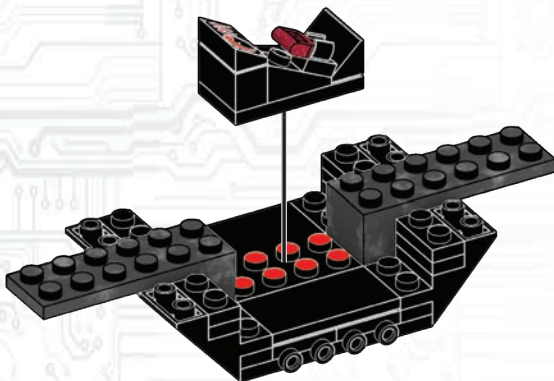

13

2X

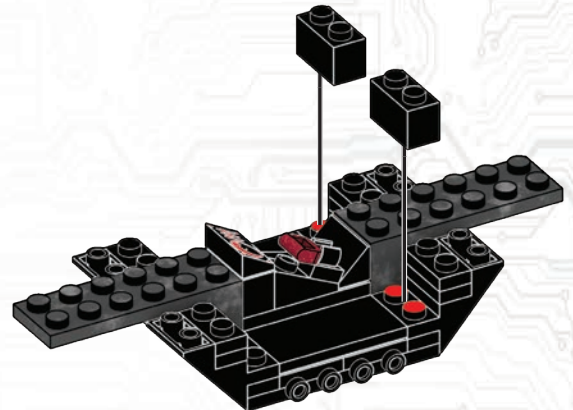

14



1X



2X



1X



Place temporary pieces. / Placer les pièces temporaire.s
 / Colocar las piezas provisionales. / Colocar as peças
 temporárias. / Posizionare i pezzi provvisori. / Die
 vorübergehend benötigten Teile platzieren. / Umieść
 tymczasowe elementy. / Plaats tijdelijke delen. /
 Поместите временные детали. / Placér midlertidige
 stykker. / Placera temporära delar. / Plasser midlertidige
 deler. / Aseta väliaikaiset osat. / Τοποθετήστε το
 προσωρινό κομμάτι. / Geçici parçaları yerleştirin. /
 Umistěte dočasné díly. / Vložte dočasné kusy. / Helyezze
 el az ideiglenes darabokat. / 暫定ピースを配置してくださ
 い / وضع القطع المؤقت

放置临时件



1

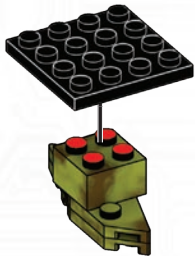

2

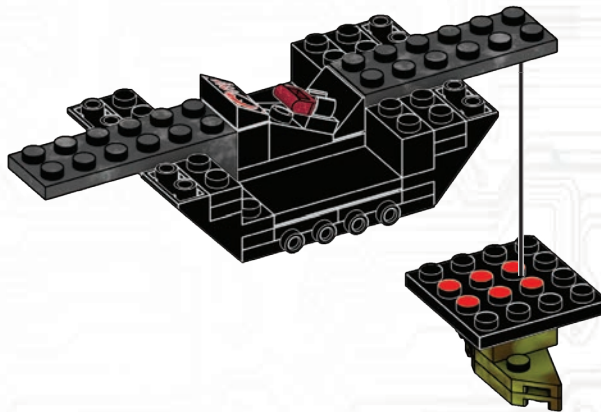

15



2X

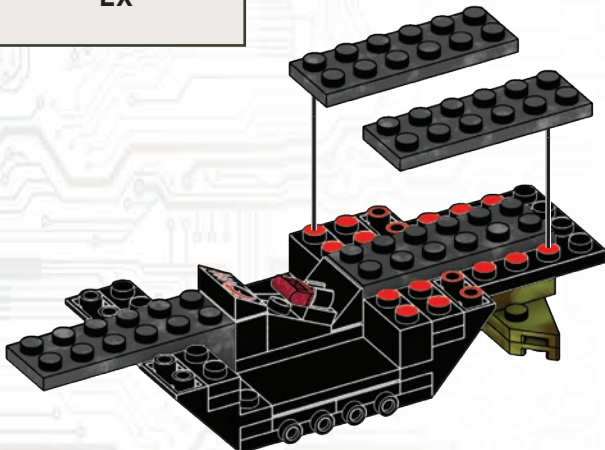

1

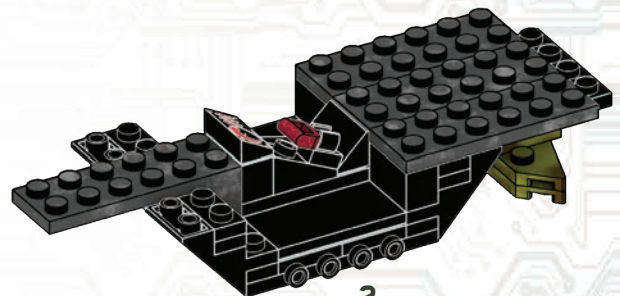

2

16

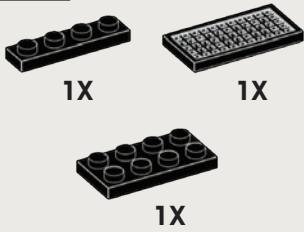

17

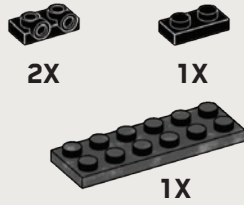

18



19

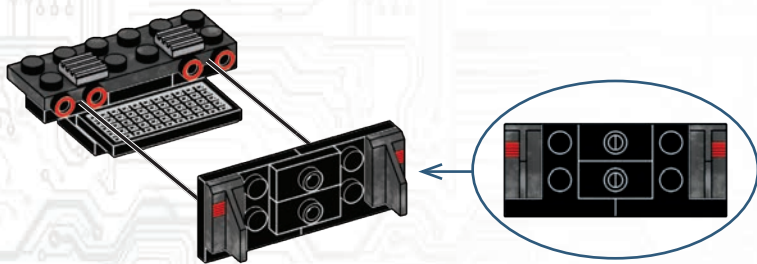
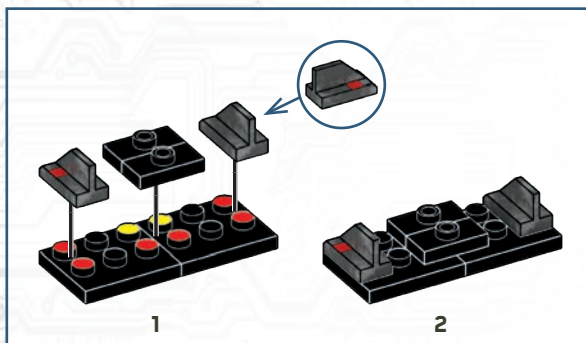

20

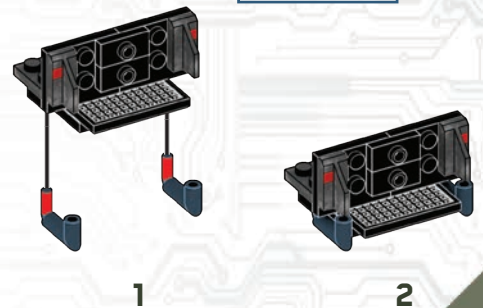
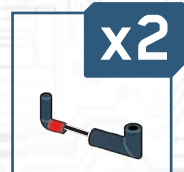
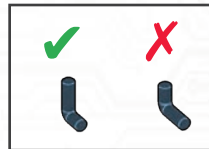
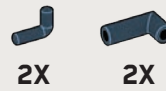

21

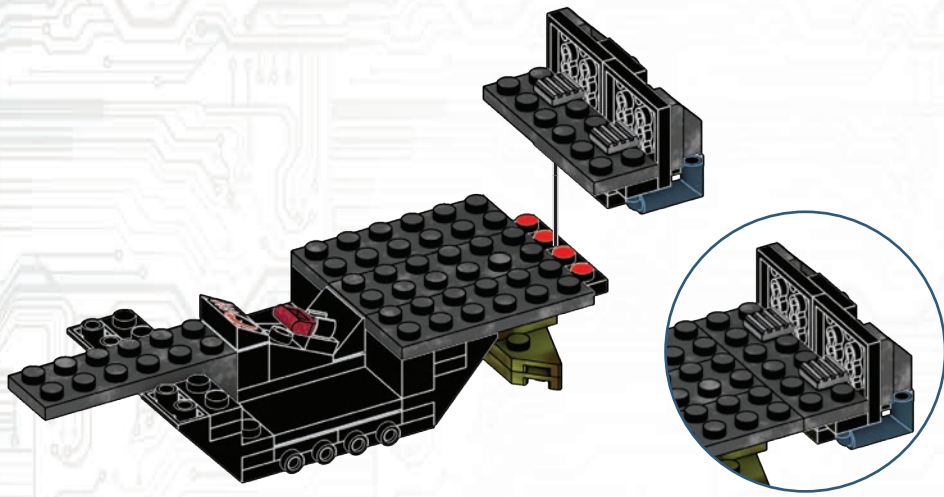

22

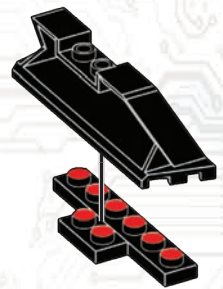
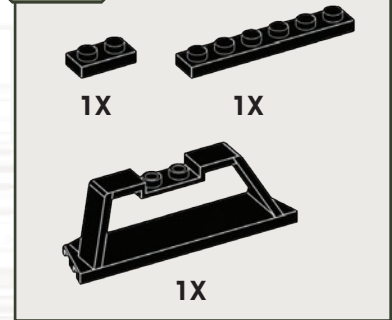

23

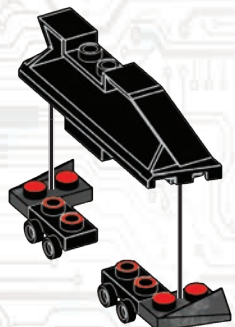
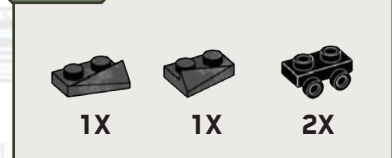

24

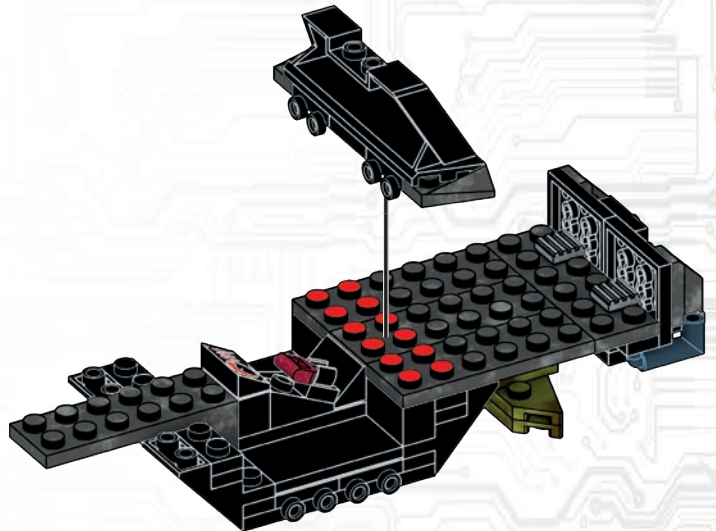

25

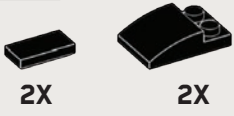

x2

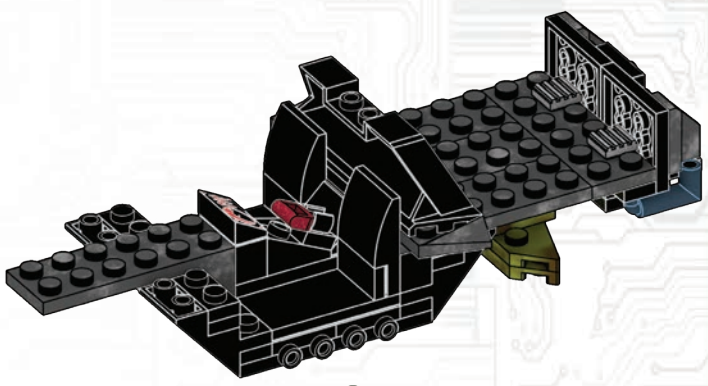
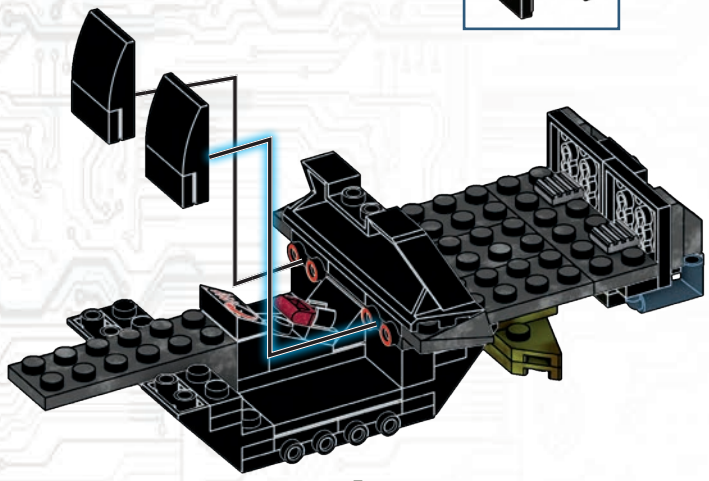
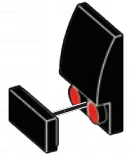

26

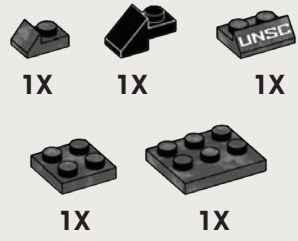

27

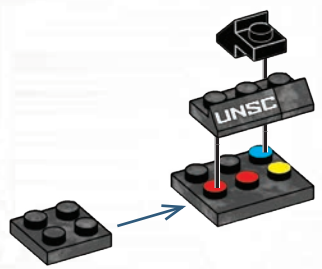

28



1X

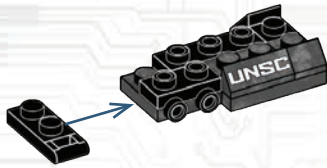

29



1X



1X



30



1X



1X



31



1X



1X



1



2

32

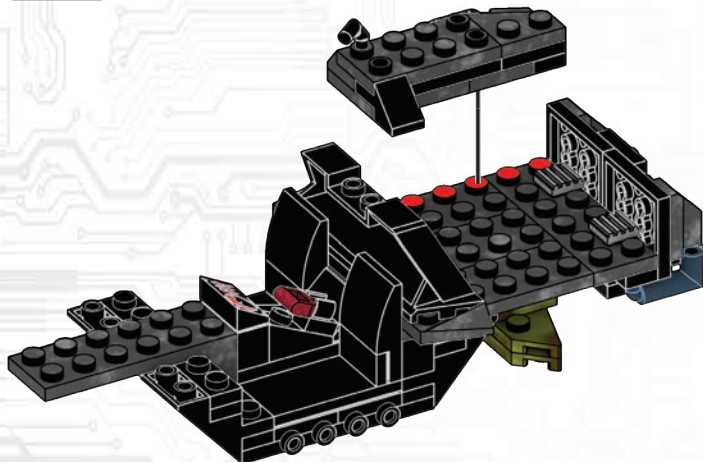

1

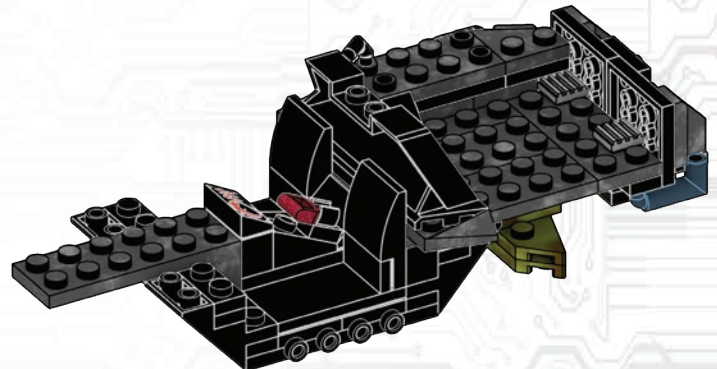

2

33



34



35



36



37

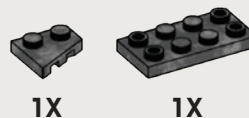

38



1



2

39

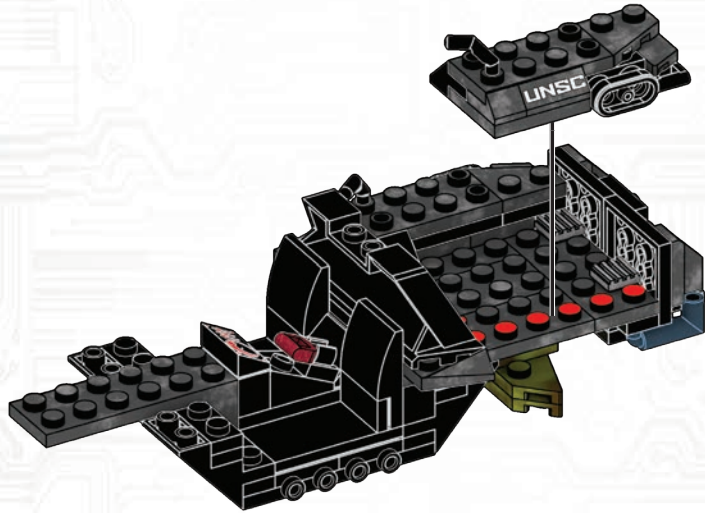

40

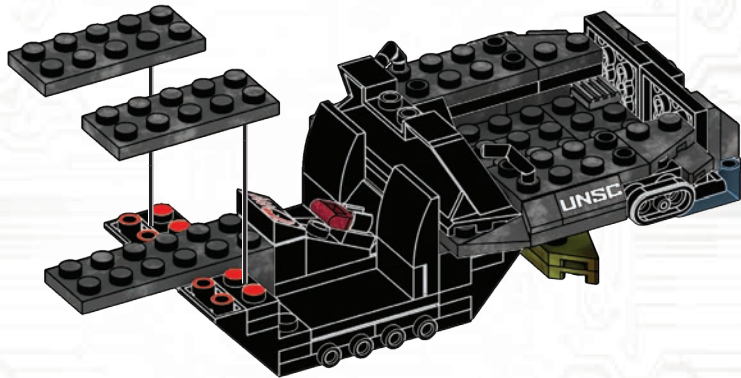

2X

This inset box shows the part required for step 40: a black 1x6 Technic brick. Below the image, the text '2X' indicates that two of these bricks are needed for the step.

41

- 1X [1x 1-hole black Technic brick]
- 2X [2x 2-hole black Technic brick]
- 1X [1x 3-hole black Technic brick]

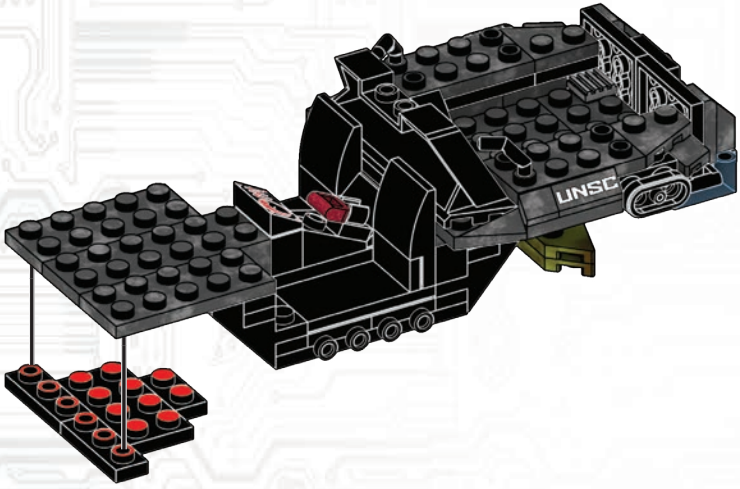
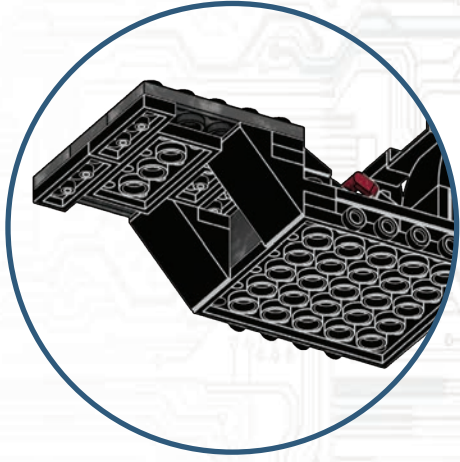

42

- 2X [2x black Technic axle]
- 2X [2x blue Technic axle connector]

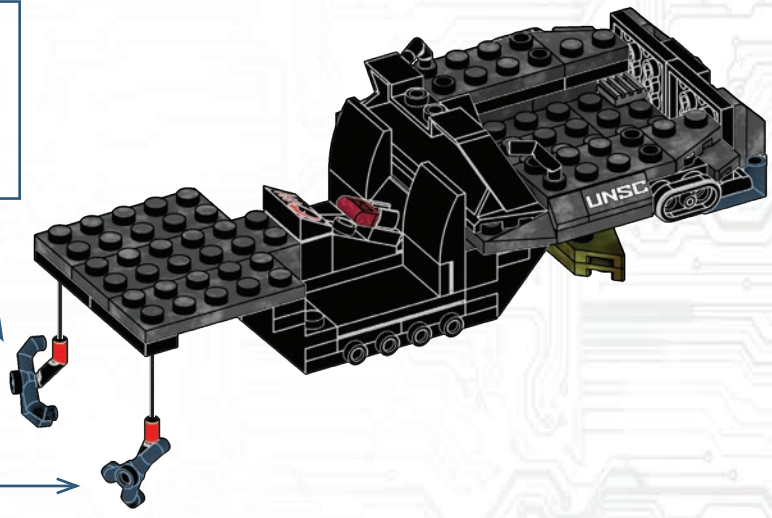
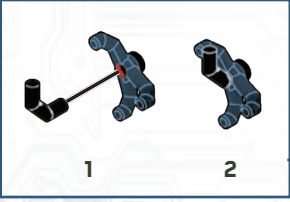
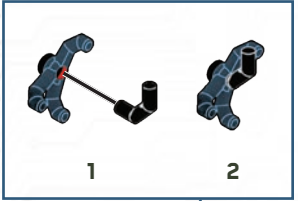

43



1X



2X



1



2

Place temporary pieces.
 Placer les pièces temporaires.
 Colocar las piezas provisionales.
 Colocar as peças temporárias.
 Posizionare i pezzi provvisori.
 Die vorübergehend benötigten Teile platzieren.
 Umieść tymczasowe elementy.
 Plaats tijdelijke delen.
 Поместите временные детали.
 Placer midlertidige stykker.
 Placera temporära delar.
 Plasser midlertidige deler.
 Aseta väliaikaiset osat.
 Τοποθετήστε το προσωρινό κομμάτι.
 Geçici parçaları yerleştirin.
 Umístete dočasné diely.
 Vložte dočasné kusy.
 Helyezze el az ideiglenes darabokat.
 暫定ピースを配置してください
 ضع القطع المؤقت

放置临时件

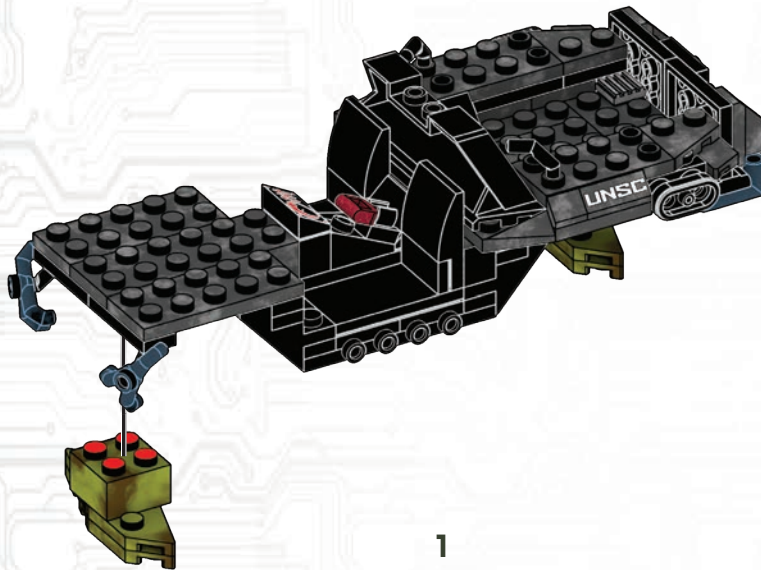

1

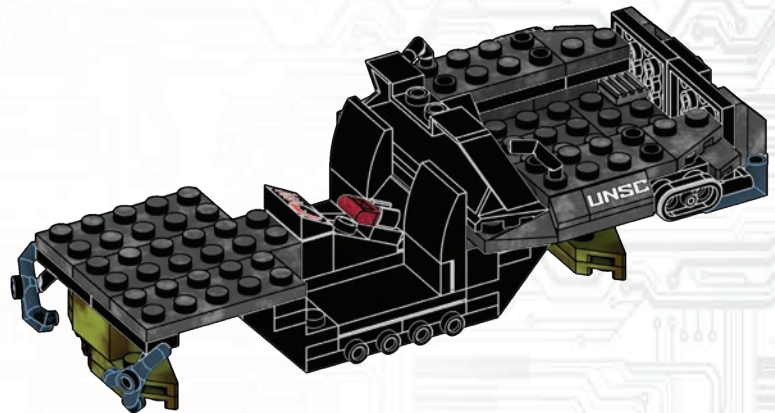

2

44



1X



2X

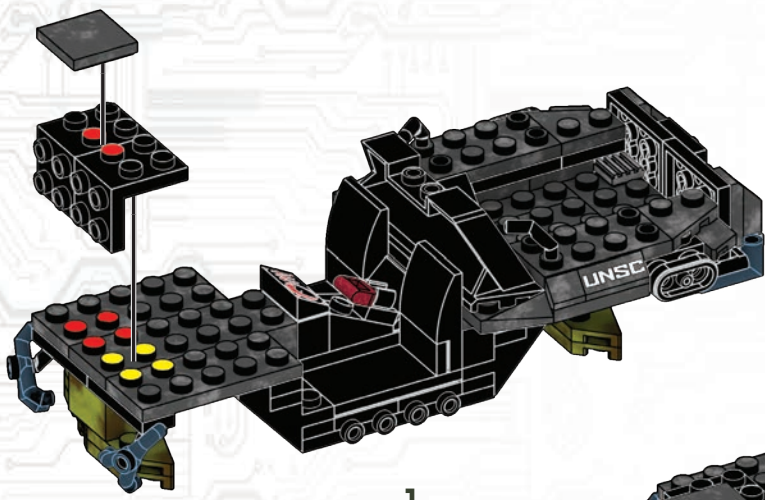

1

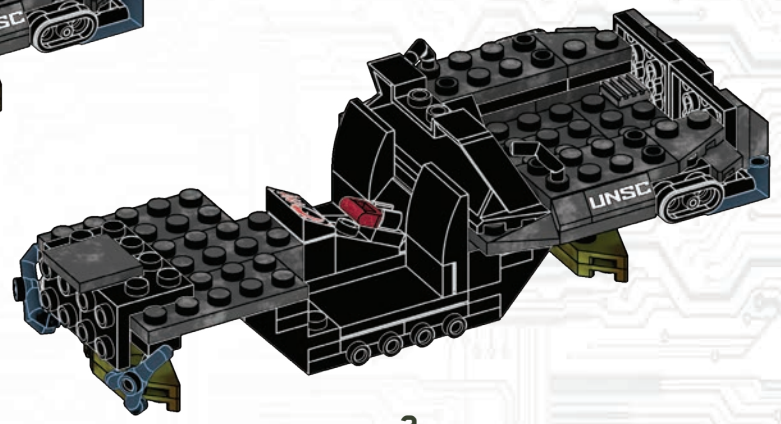

2

45



1X



1X



1X

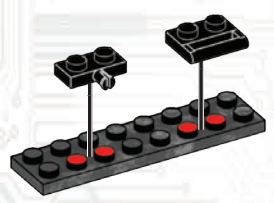

46



2X



1X

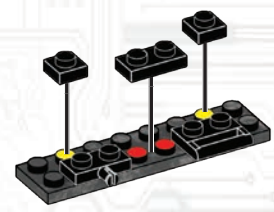

47



1X



2X

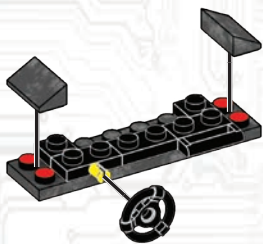

1

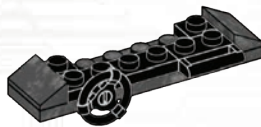

2

48

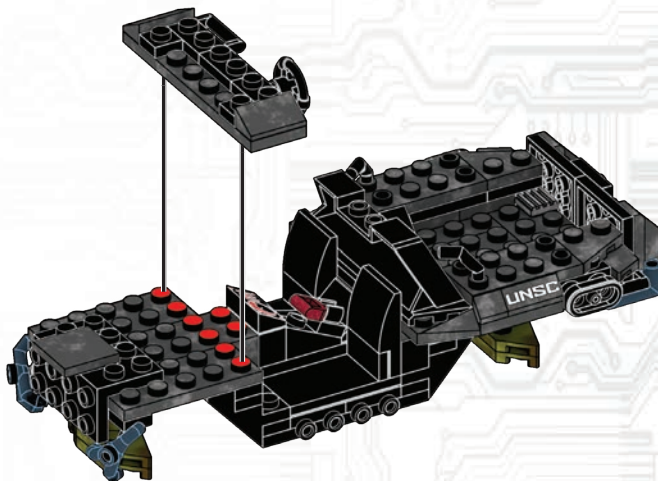

49



1X



1X

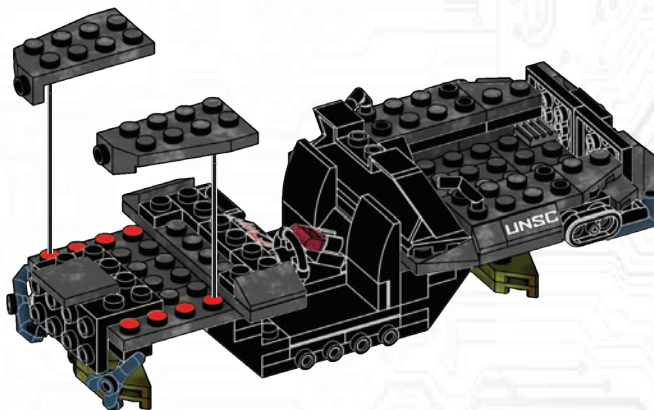

50



1X

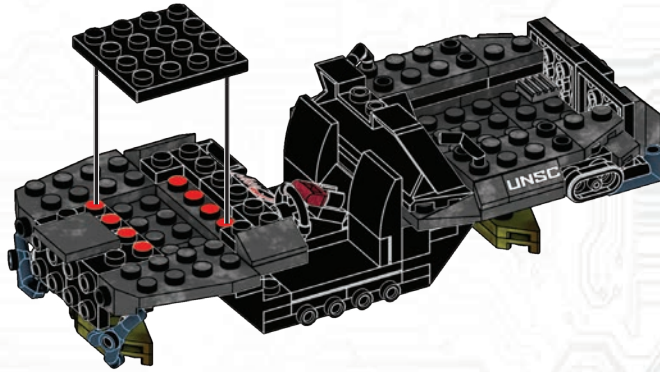

51



1X



1X

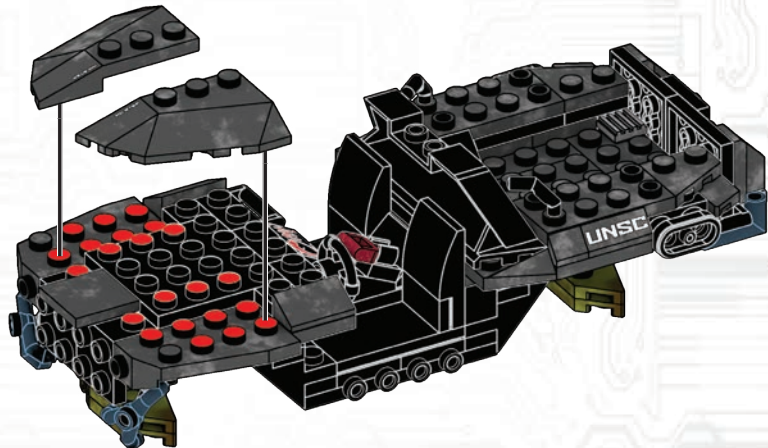

52



1X



1X

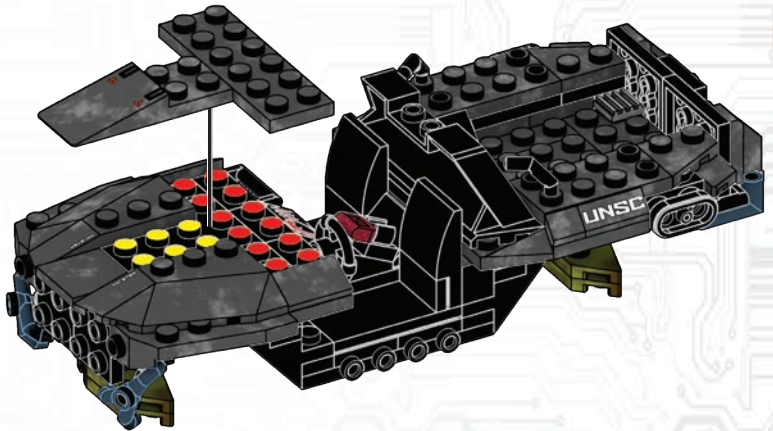

53



2X



1X

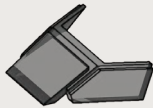

1X



1X

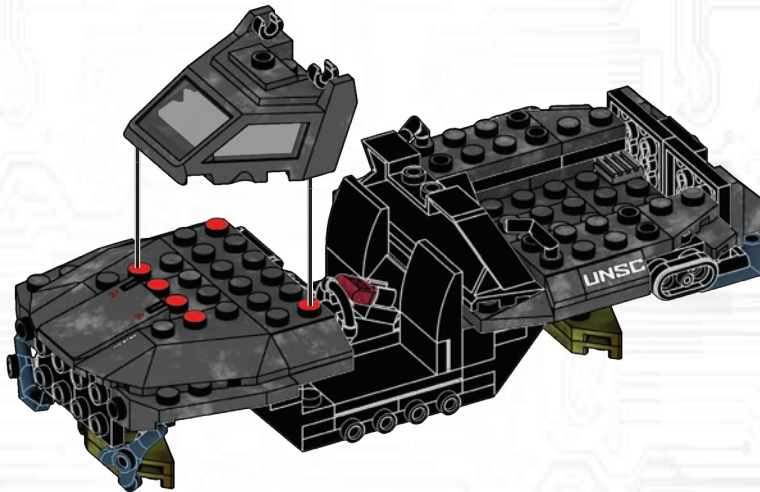
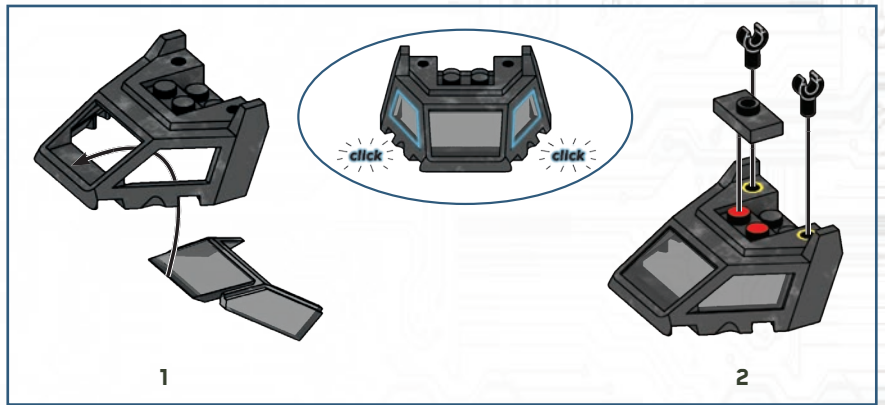



54



1X



1X



1X

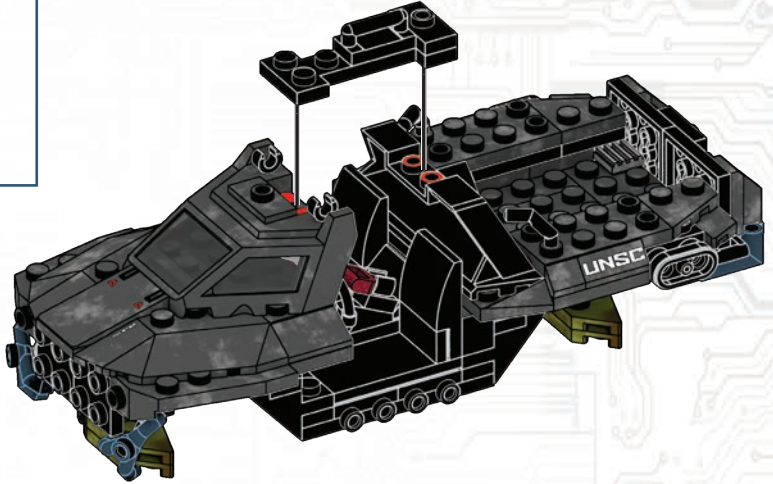
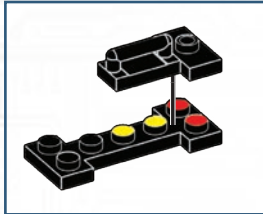

55



1X



1X

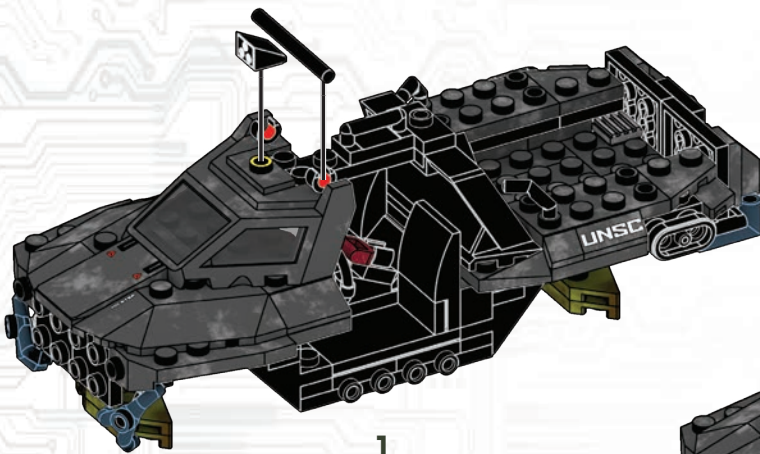

1

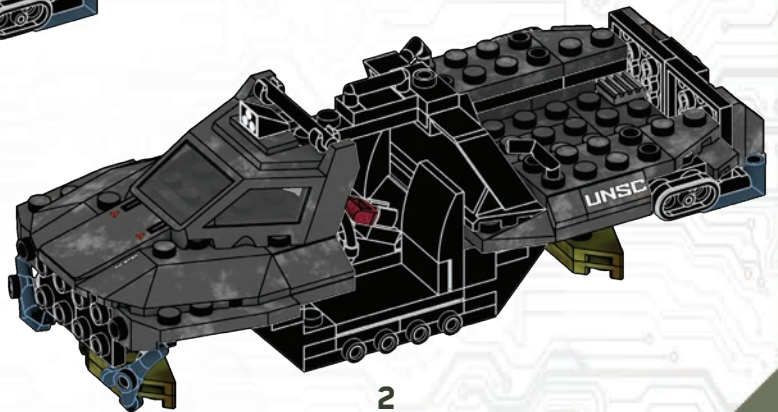

2

56



2X



1X



1X



1



2

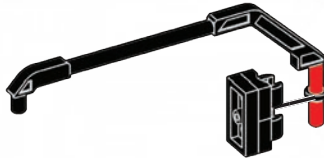

3



4

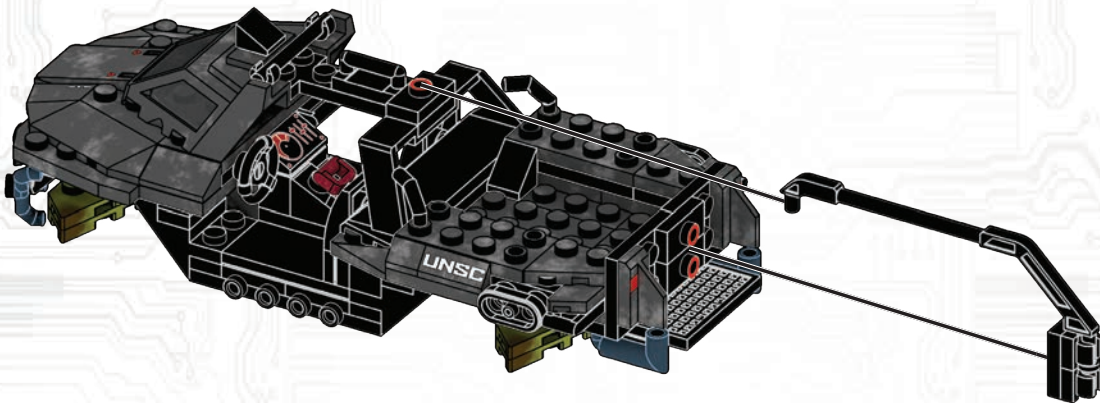

1

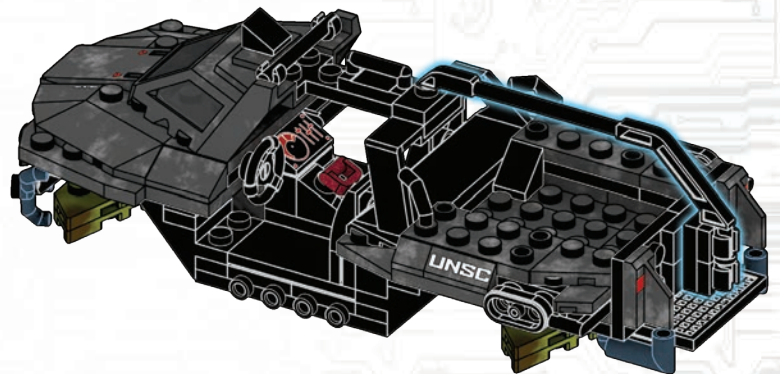

2

57

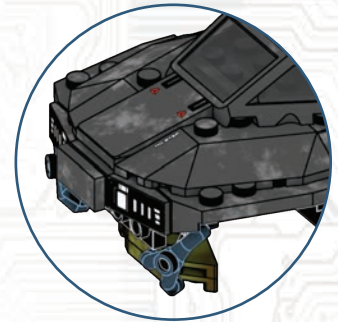
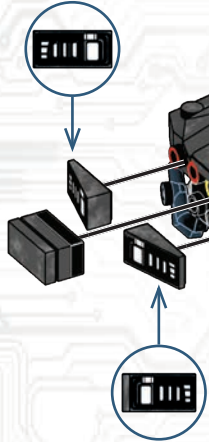

x2

58

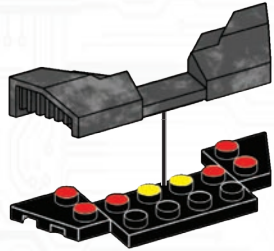
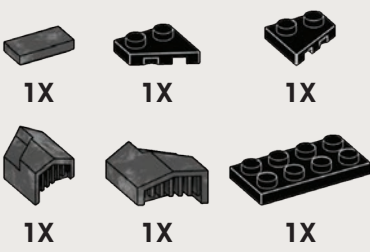

59

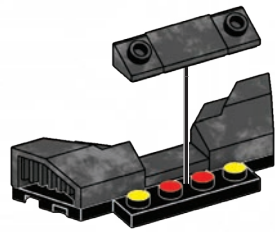

60

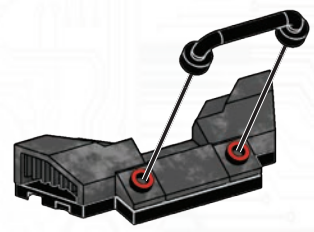

61

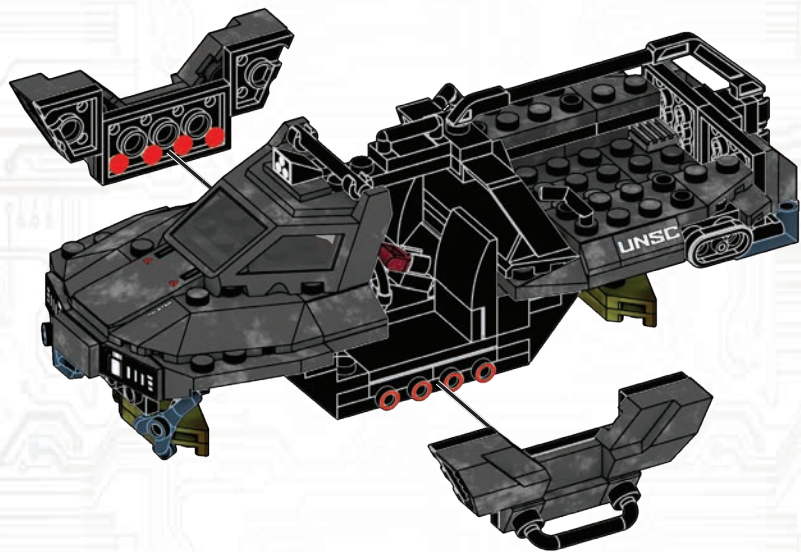

62



Remove temporary pieces.
 Retirer les pièces temporaires.
 Retirar las piezas provisionales.
 Remover as peças temporárias.
 Rimuovere i pezzi provvisori.
 Die vorübergehend benötigten Teile entfernen.
 Usunąć elementy tymczasowe.
 Verwijder tijdelijke delen.
 Удалите временные детали.
 Fjern midlertidige stykker.
 Ta bort temporära delar.
 Fjern midlertidige deler.
 Poista väliaikaiset osat.
 Αφαιρέστε τα προσωρινά κομμάτια.
 Geçici parçaları çıkarın.
 Odstraňte dočasné diely.
 Wybierz dočasné kusy.
 Távolítsa el az ideiglenes darabokat.
 暫定ピースを外してください

انزع القطع المؤقتة
 移除临时件

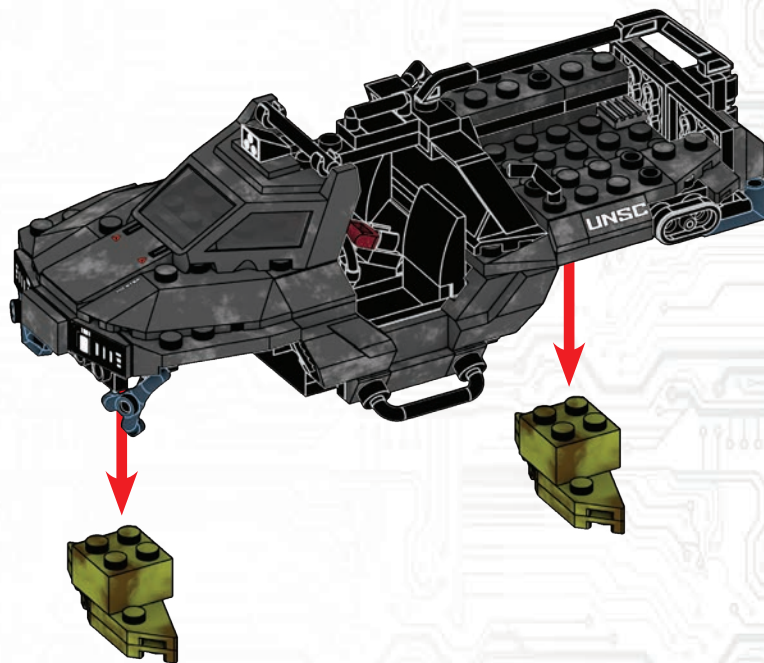

63

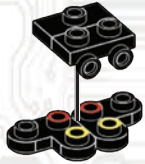

64

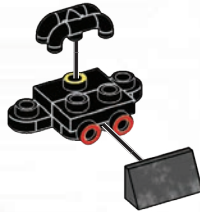

65

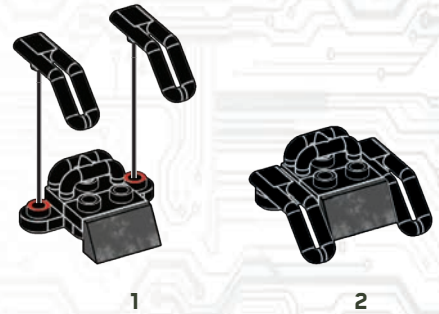

66

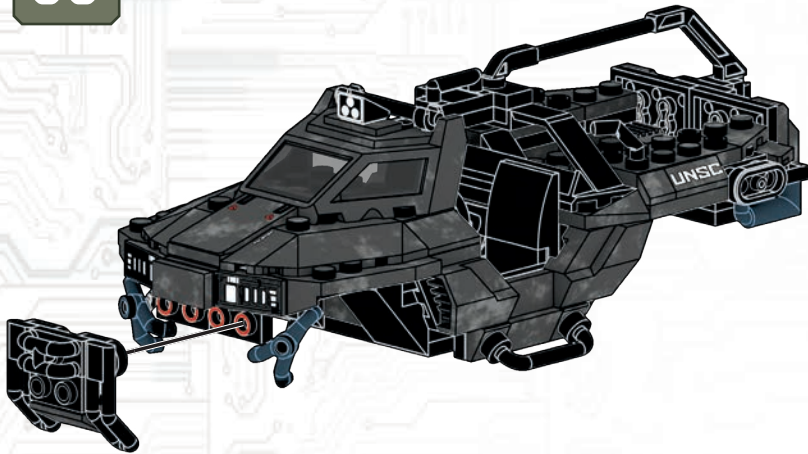

x2

67



4X

1X

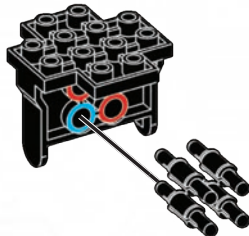

68



4X

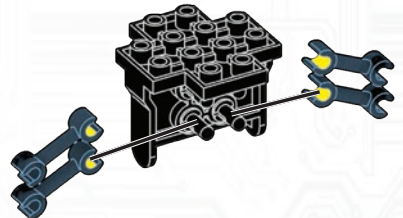

69



4X



2X

x2

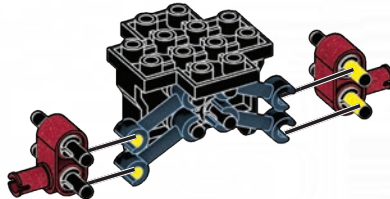
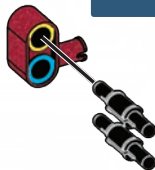

1

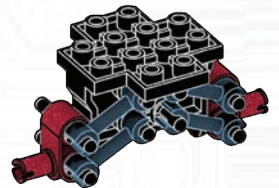

2

70



1X

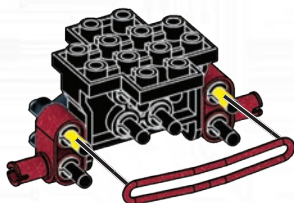

1

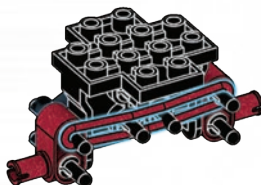

2

71



4X

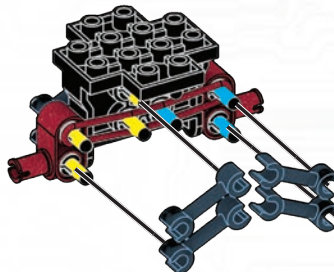

1

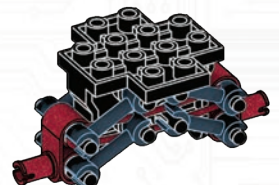

2

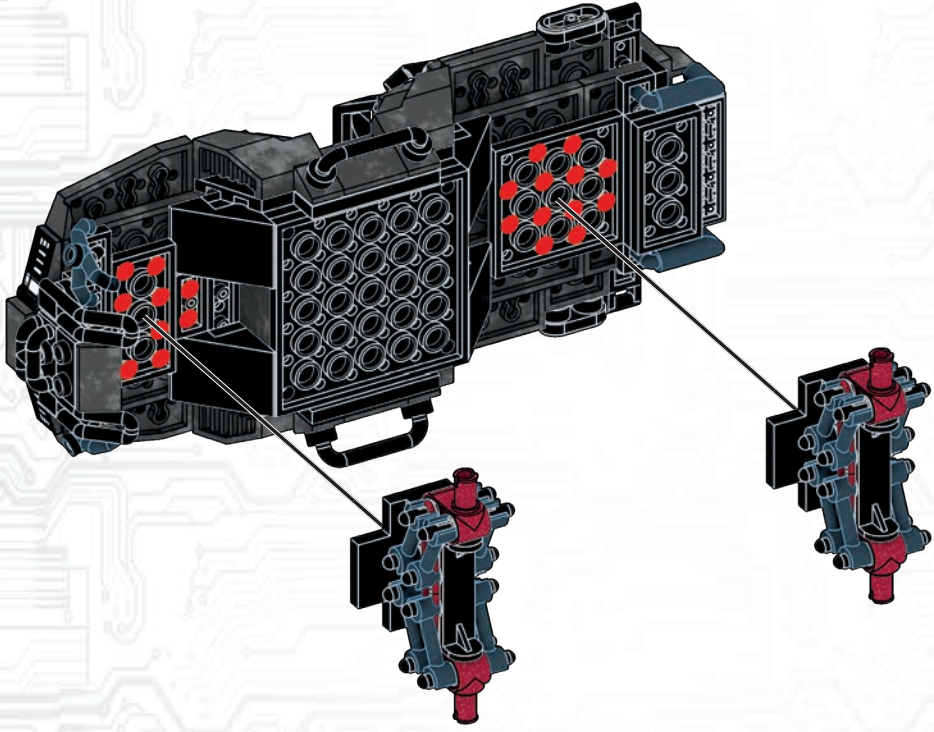

1

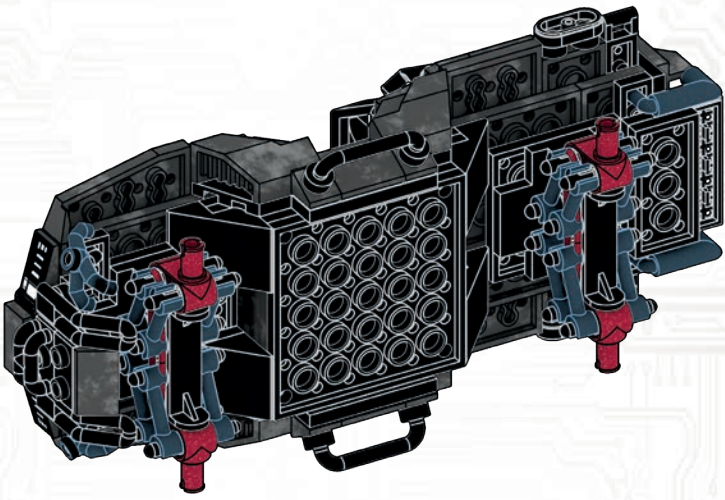

2

73



2X



2X

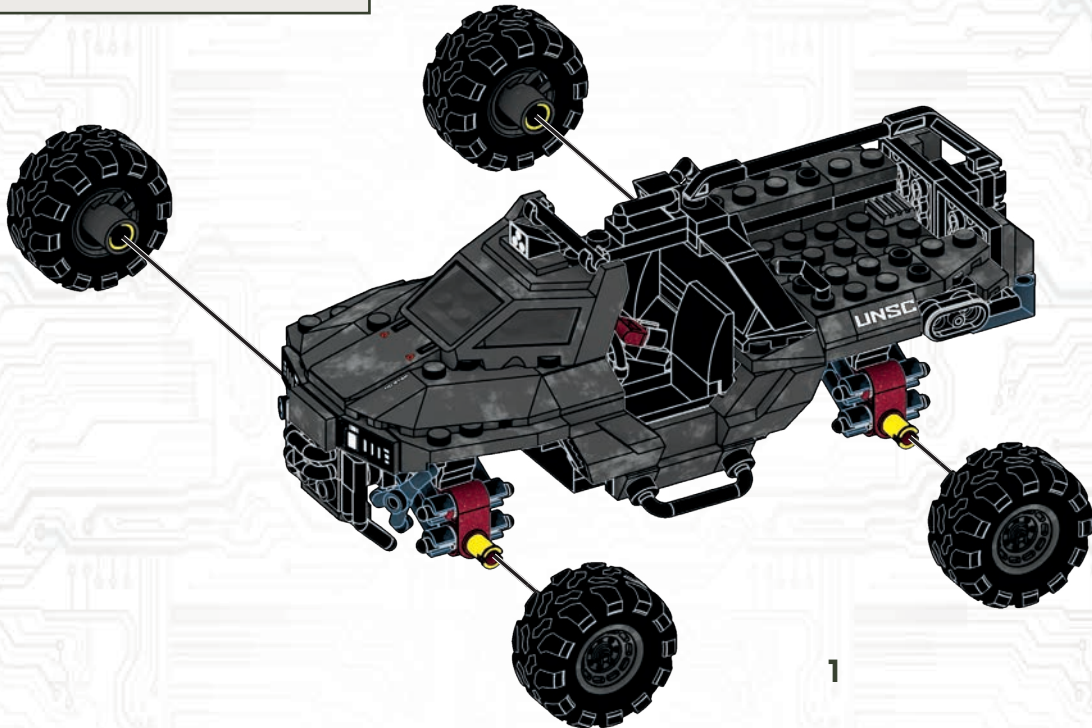

1

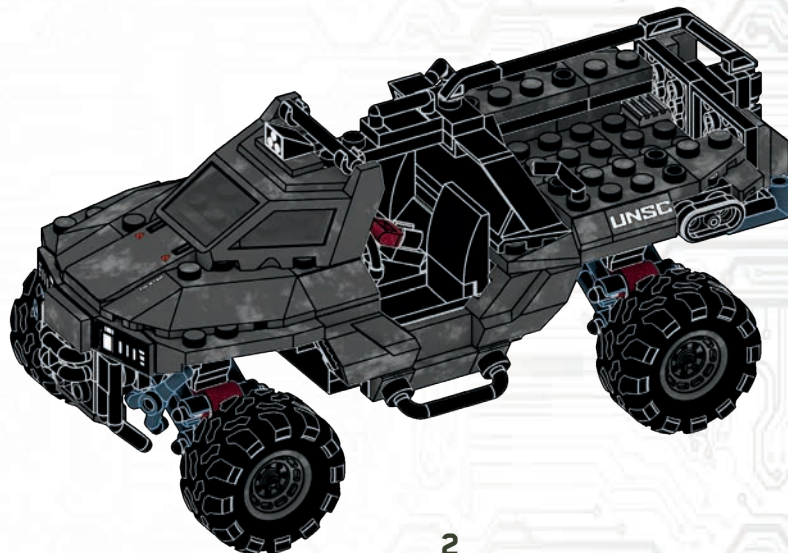

2



BRUTE WARRIOR



GRUNT MULE

SPARTAN KELLY-087



UNSC MARINE



ACTIVE SUSPENSION
SUSPENSION ACTIVE

SUSPENSIÓN ACTIVA - SUSPENSÃO ATIVA
BEWEGLICHE FEDERUNG - АКТИВНАЯ ПОДВЕСКА

UNSC RAZORBACK BLITZ • ATTAQUE UNSC RAZORBACK
BOMBARDEO UNSC RAZORBACK • OFENSIVA RAZORBACK UNSC
BLITZ UNSC RAZORBACK | UNSC RAZORBACK BŁYSKAWICZNY ATAK ZESTAW | ТАНКОВАЯ АТАКА | UNSC RAZORBACK ROHAM
NÁJEZD UNSC RAZORBACK | هجوم UNSC RAZORBACK BLITZ

2X  AM17062F

6X  AM03328F

2X  AM79666APG

1X  AS-GYG59-03

2X  AM19392ALH

4X  AM72001AJL

3X  AM19999F

4X  AM76052F

1X  AM76060AKM

1X  AM74299AJL

1X  AM74300AJL

2X  AM19530AJL

2X  AM74645ALH

3X  AM022501AJL

2X  AM022501F

1X  AM07590AJL

4X  AM07590F

1X  AM18221F

12X  AM09393F

1X  AM09393AJL

2X  AM79070F

9X  AM76467F

2X  AM16649F

1X  AM77573F

1X  AM15480AJL

1X  AM15481AJL

1X  AS-GYG59-01

1X  AS-GYG59-02

1X  AM17128F

2X  AM18740F

1X  AM18559F

1X  AM18665AJL

2X  AM18665F

1X  AM18666AJL

2X  AM18666F

1X  AS-GYG59-10

1X  AS-GYG59-09

1X  AS-GYG59-04

5X  AM18549AJL

1X  AM03019F

1X  AM04429F

3X  AM09013F

2X  AM16972F

2X  AM16954F

2X  AS-GYG59-05

1X  AM72000F

1X  AM0948AJL

2X  AM03773AJL

2X  AM09023AJM

16X  AM77492F

2X  AM79721AKM

16X  AM76653ALH

2X  AM79424ALH

1X  AM18220F

4X  AM80745AKM

4X  AM72600F

2X  AM09931F

2X  AM77747F

1X  AM76521F

2X  AM19012F

2X  AM74139AJL

2X  AM74139F

1X  AM09593F

2X  AM01141F

2X  AM73900AJL

2X  AM73901AJL

4X  AM18230F

1X  AM18276F

2X  AM79019AJL

5X  AM09493F

1X  AS-GYG59-06

1X  AM17148F

1X  AM77463F

4X  AM76357AJM

1X  AM81228AJL

1X  AM81227AJL

2X  AM80965AJL

4X  AM01480AJL

1X  AS-GYG59-08

1X  AS-GYG59-07

1X  AM18617F

2X  AM17054F

1X  AM81225AGY

1X  AM81226AJL

1X  AM18218F

5X  AM09292F

1X  AM08483AJL

2X  AM80747AJL

1X  AM80855MCX



2X
AM80746F



2X
AS-GYG59-11



2X
AS-GYG59-12

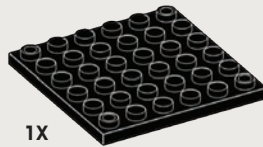

1X
AM74681F



1X
AM81229F



1X
FIG-GYG59-A



1X
FIG-GYG59-B



1X
FIG-GYG59-C



1X
FIG-GYG59-D



1X
AM17622AYB



1X
AM74941MM



1X
AM75907AKM



1X
AM18167AKM



1X
AM19981AKM



2X
AM80852AKM

Missing pieces?
Pièces manquantes?
¿Partes faltantes? · Perdeu peças?
Fehlen Teile? · Не хватает деталей?

support.megabrands.com

Instructions included for main model only. Other build(s) can be found at megaconstrux.com / Instructions incluses pour le modèle principal uniquement. Les instructions pour l'(les) autre(s) modèle(s) de construction se trouvent sur le site megaconstrux.com / Nur für das Hauptmodell ist eine Anleitung enthalten. Unter megaconstrux.com finden Sie weitere Bauanleitungen. / Istruzioni incluse solo per il modello principale. È possibile trovare le altre costruzioni su megaconstrux.com / Instructies alleen bij het hoofdmodel. Andere bouw mogelijkheden kunt u vinden op megaconstrux.com / Se incluyen las instrucciones para el modelo principal solamente. Se pueden encontrar otras construcciones en megaconstrux.com / Instruções incluídas somente para o modelo principal. Outras montagens podem ser encontradas em megaconstrux.com / Instruktioner medföljer endast för huvudmodellen. Andra byggen finns på megaconstrux.com / Ohjeet ovat sisällytetyinä vain päämalliin. Muut kokoonpanot ovat löydettävissä osoitteessa megaconstrux.com / Vejlendingen følger kun med hovedmodellen. Andre byggemodeller kan findes på megaconstrux.com / Instruksjoner kun inkludert for hovedmodell. Annen/andre versjon/-er finner du på megaconstrux.com / Załączono instrukcje tylko do głównego modelu. Inne wersje są dostępne na megaconstrux.com / Příbalené pokyny jsou pouze pro hlavní model. Ostatní stavby lze najít na megaconstrux.com / Příbalené pokyny sú iba hlavný model. Ostatné stavby možno nájsť na megaconstrux.com / A mellékelt utasítások csak a fő modellre vonatkoznak. Egyéb építőelem(ek) a megaconstrux.com weboldalon található(k) / Инструкция относится только к основной модели. Другие конструкции можно найти на сайте megaconstrux.com / Οι οδηγίες που περιλαμβάνονται είναι μόνο για το κύριο μοντέλο. Μπορείτε να βρείτε άλλες κατασκευές στο megaconstrux.com / Yönergeler sadece ana modeller için dahil edilmştir. Diğer yapı parçaları megaconstrux.com adresinde bulunabilir /

メインのモデルのみの取扱説明書が含まれています。他のmegaconstrux.comにあります。

megaconstrux.com موقع أخرى على بناء (أينية) فقط. يمكن العثور على بناء (أينية) فقط. / 拼搭指南仅包含主体部分的拼搭指导。其他部分拼搭指导可以上 megaconstrux.com 查找

Mattel Europa B.V., Gonderl 1, 1186 MJ Amstelveen, Nederland. Mattel U.K. Limited, The Porter Building, 1 Brunel Way, Slough SL1 1FQ, UK. Mattel France, Parc de la Cerisaie, 1/3/5 allée des Fleurs, 94260 Fresnes Cedex. N° Cristal 0969 36 99 99 (Numéro non surtaxé) ou www.lesjouetsmattel.fr Mattel Belgium, Trade Mart, Atomiumsquare, Bogota 202 - B 275, 1020 Brussels. Gratis nummer België: 0800 - 16 936 - Gratis nummer Luxemburg: 800 - 22 784 - Gratis nummer Nederland: 0800 - 262 88 35. Deutschland: Mattel GmbH, Solmsstraße 4, D-60486 Frankfurt am Main, Schweiz: Mattel AG, Kirchstrasse 24, CH-3097 Liebfeld. Österreich: Mattel Ges.m.b.H., Campus 21, Liebermanstraße A01 404, A- 2345 Brunn/Gebirge. Mattel Italy Srl, Via Bracco, 6-MAC 6, 20159 Milano, Italy. Servizio assistenza clienti: Customersrv.italia@mattel.com - Numero verde 800 11 37 11. Mattel España, S.A., Aribau 200, 08036 Barcelona, cservice.spain@mattel.com Tel: 902203010 http://www.service.mattel.com/es. Mattel East Asia Ltd., Room 503-09, North Tower, World Finance Centre, Harbour City, Tsimshatsui, HK, China. Tel: (852) 3185-6500. Diimport & Diedarkan Oleh: Mattel Continental Asia Sdn Bhd Lt. Level 19, Tower 3, Avenue 7, No. 8 Jalan Kerinchi, Bangsar South, 59200 Kuala Lumpur, Malaysia. Mattel South Africa (PTY) LTD, Office 10213, 30 Melrose Boulevard, Johannesburg 2196. Dystrybutor: Mattel Poland Sp. z o.o., Warsaw Trade Tower 34 p., ul. Chłodna 51, 00-867 Warszawa. Mattel Australia Pty. Ltd, 658 Church St., Richmond, Victoria, 3121. Consumer Advisory Service - 1300 135 312. Mattel AEBE, Εβγούγου Μακροπίου 1, Κτήριο Κ-2, ΤΚ 17561, Παλαιό Φάληρο, Mattel Oyuncakçılık Tic. Ltd. Şti. İçerenköy Mah., Erkut Sok. A Blok No:12 Üner Plaza Kat:9-10 34752 Ataşehir İstanbul. Tel: 0216 570 75 00. Импортёр/Уполномоченная организация: ООО "МАТТЕЛ" Российская Федерация, 105120 Москва, 2-й Сыромятинский переулок, 1; +7 495 287 79 39. Forg: Mattel Toys Hungary Kft 1139 Budapest Váci út 91. +36 1 270 0223. Mattel Czech Republic s.r.o., The Forum, Václavské nám. 19, 11000 Praha 1. Mattel, 333 Continental Boulevard, El Segundo, CA 90245, USA. Consumer Services: 1-800-465-MEGA (6342). Importado y distribuido por Mattel de México, S.A. de C.V., Miguel de Cervantes Saavedra No. 193, Pisos 10 y 11, Col. Granada, Alcaldía Miguel Hidalgo, C.P. 11520, México, Ciudad de México. R.F.C. MME-920701-NB3. Tels: 59-05-51-00 Ext. 5206 ó 01-800-463-59-89. Mattel Chile, S.A., Avenida América Vespuccio 501-B, Quilicura, Santiago. Tel: 1230-020-6213. Servicio al consumidor Venezuela: Tel: 0-800-100-9123. Mattel Argentina, S.A., Av. Libertador 1000, Piso 11 - Oficinas 109 y 111, Vicente López - Prov. Buenos Aires. Tel: 0800-666-3373. Mattel Colombia, S.A., Calle 123#7-07 P.5, Bogotá. Tel: 01800-710-2069. Mattel Perú, S.A., Av. Juan de Arona # 151, Centro Empresarial Juan de Arona, Torre C, Piso 7, Oficina 704, San Isidro, Lima 27, Perú. RUC: 20425853865. Reg. Importador: 02350-12-JUE-DIGESA. Tel: 0800-54744. E-mail Latinoamérica: servicio.clientes@mattel.com. Mattel do Brasil Ltda.- CNPJ: 54.558.002/0001-20 - Rua Verbo Divino, 1488 - 2º Andar - 04719-904 - Chácara Santo Antônio - São Paulo - SP - Brasil. Serviço de Atendimento ao Consumidor: fone 0800 575 0780. E-mail: sac.matteldobrazil@mattel.com



© 2020 Microsoft Corporation. All Rights Reserved. Microsoft, Halo, the Halo logo, Xbox, the Xbox logo, and 343 Industries are trademarks of the Microsoft group of companies.



HALO

**MORE TO COLLECT!
ENCORE PLUS
À COLLECTIONNER!
MÁS PARA
COLECCIONAR!**

**MAIS PARA
COLECCIONAR!
MEHR ZUM
SAMMELN!
СОБЕРИ БОЛЬШЕ!**



GYG58



GYG60



Set(s) sold separately and subject to availability. / Ensemble(s) vendu(s) séparément. Certains produits peuvent ne pas être commercialisés. / Se vende(n) por separado y está(n) sujeto(s) a disponibilidad. / Conjunto(s) vendido(s) em separado e sujeito(s) à disponibilidade. / Set in vendita separatamente, secondo disponibilità. / Das/Die Set(s) sind separat erhältlich. / Zestaw(y) sprzedawany(e) oddzielnie w zależności od dostępności. / Set(s) apart verkrijgbaar en afhankelijk van beschikbaarheid. / Набор(-ы) продаются отдельно, при наличии. / Set sælges separat og så længe lager haves. / Seten säljs separat så länge lagret räcker. / Settet/settene selges separat så langt lageret rekker. / Pakkaus/pakkaukset myydään erikseen, saatavuus voi vaihdella. / Το(α) σετ πωλούνται ξεχωριστά και ανάλογα με τη διαθεσιμότητα. / Setler ayrı olarak satılır ve stoklarla sınırlıdır. / Set (sety) se prodává (prodávají) samostatně dle aktuální nabídky. / Súprava/-y sa predáva(jú) samostatne a podľa dostupnosti. / A készlet(ek) külön kapható(k), az elérhetőség változhat. / セット商品は別売りになります。在庫状況は別途ご確認をお願いします。 / تباع المجموعة أو المجموعات على حدة وتخضع لتوافرها.

每套单独发售，按供货情况决定。



© D714,887, D781,964, D797,203, D841,101

©2020, MEGA Brands Inc. & MEGA Brands Inc. CONSTRUX™ is owned by Mattel and used under license. CONSTRUX™ appartient à Mattel et est utilisée sous licence. Printed in China / Imprimé en Chine AD-GYG59-01

UK
CA

1186 MJ, 1, NL

Mattel Canada Inc. Mississauga, Ontario L5R 3W2.
MADE IN CHINA. FABRIQUÉ EN CHINE. FABRICADO NA / HECHO EN CHINA.
ИЗГОТОВЛЕНО В КИТАЕ. ÇIN'DE ÜRETİLMİŞTİR. صنع في الصين

