

Parts

- A. Roof
- B. 2 Facades
- C. Turntable
- D. Window Wall
- E. Train Wash Bay
- F. Train Wash Arch
- G. Fuel Bay
- H. Ramp Track

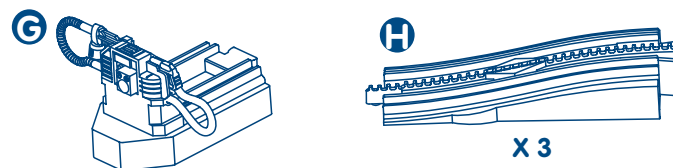
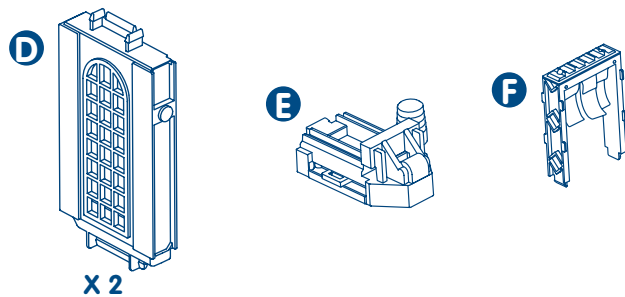
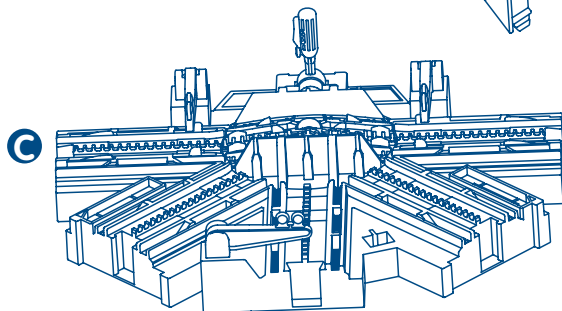
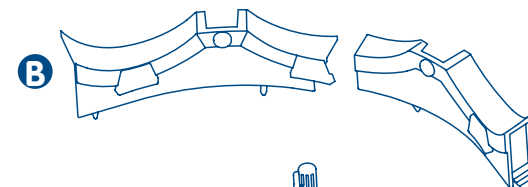
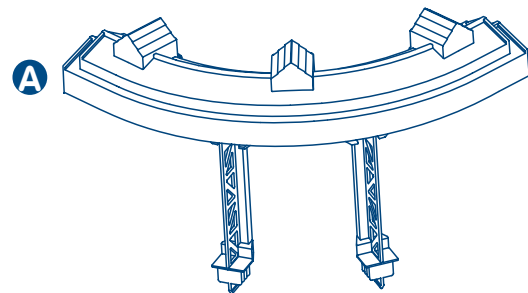

Please keep this instruction sheet for future reference, as it contains important information.

Adult assembly is required.

No tools needed for assembly.

Fisher-Price®

GeoTrax™

Rail & Road System

Visit www.fisher-price.com to see the entire world of GeoTrax™ accessories!

Questions? We'd like to hear from you!

Call Fisher-Price® Consumer Relations, toll-free at **1-800-432-5437**,

8 AM - 6 PM EST Monday through Friday. Hearing-impaired

consumers using TTY/TDD equipment, please call 1-800-382-7470.

Or, visit us on line at www.service.mattel.com.

Write to us at:

Fisher-Price® Consumer Relations

636 Girard Avenue

East Aurora, New York 14052

For countries outside the United States:

CANADA: Questions? 1-800-432-5437. Mattel Canada Inc., 6155 Freemont Blvd., Mississauga, Ontario L5R 3W2; www.service.mattel.com.

GREAT BRITAIN: Mattel UK Ltd, Vanwall Business Park, Maidenhead SL6 4UB. Helpline: 01628 500302.

AUSTRALIA: Mattel Australia Pty. Ltd., 658 Church Street, Locked Bag #870, Richmond, Victoria 3121 Australia. Consumer Advisory Service 1300 135 312.

NEW ZEALAND: 16-18 William Pickering Drive, Albany 1331, Auckland.

ASIA: Mattel East Asia Ltd, Room 1106, South Tower, World Finance Centre, Harbour City, Tsimshatsui, HK, China.

Fisher-Price®



GeoTrax™

Rail & Road System

Workin' Roundhouse™

Assembly

1 **FAÇADE** **ROOF**

- Position the roof so the bottom is facing you.
- **"Snap"** the two facades into the roof, as shown.

2 **WINDOW WALL ★** **WINDOW WALL ▲**

- **"Snap"** the two window walls into the roof, as shown.

3 **TURNTABLE**

- **"Snap"** the roof assembly into the turntable.

4 **TRAIN WASH ARCH** **TRAIN WASH BAY**

- **"Snap"** the train wash arch onto the train wash bay.

5 **RAMP TRACK** **FUEL BAY** **TRAIN WASH BAY** **RAMP TRACK**

- Fit ramp tracks, and the two bays onto the roundhouse turntable, as shown.

Note: The locations of the fuel bay and train wash bay can be interchanged.

So Many Ways to Go!

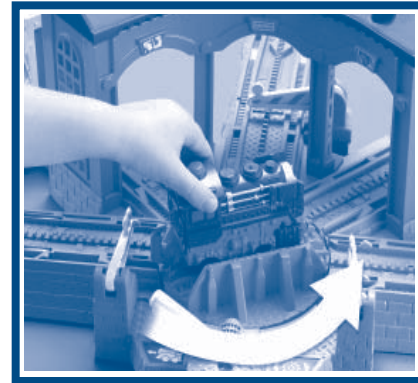

Turn your train and push it into any bay



Slide the arch back and forth to "wash" your train.



Drive through the roundhouse or put your train there to "sleep" for the night.

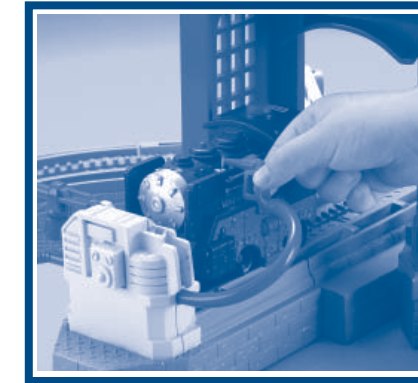

Pull into the fuel bay to fill up or fix up.

Add your RC Train for the Magic of GeoMotion™!



Flip the GeoMotion™ switch.



Use your remote controller to drive your RC engine onto the turntable. The engine will automatically uncouple any cars that are attached.

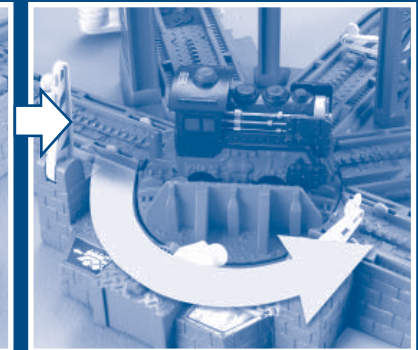

GeoMotion™ rotates the turntable. Flip the GeoMotion™ switch again to travel down any track or into the bays!

The more you collect, the more fun it gets!



Multiple track packs used to create this configuration. Each sold separately and subject to availability.