

NETFLIX
SQUID
GAME



HYL45



HOW FAR ARE YOU WILLING TO GO TO WIN?

YOU WATCHED 456 PLAYERS BATTLE IT OUT FOR A FORTUNE. NOW IT'S YOUR TURN TO PLAY. RECREATE THE ICONIC STAIRCASE FROM THE HIT SERIES SQUID GAME, COMPLETE WITH WORKERS AND THE ENIGMATIC FRONT MAN. CAP OFF YOUR BUILDING BY TURNING THE CRANK, TO SEE THE WORKERS CLIMB THE STEPS.
LET THE GAMES BEGIN.

JUSQU'OUÛ IREZ-VOUS POUR GAGNER ?

VOUS AVEZ REGARDÉ 456 JOUEURS S'AFFRONTER POUR UNE COQUETTE SOMME D'ARGENT. DÉSORMAIS, C'EST À VOUS DE JOUER. RECRÉEZ L'EMBLÉMATIQUE ESCALIER DE SQUID GAME, LA SÉRIE À SUCCÈS, AVEC LES GARDES ET L'ÉNIGMATIQUE AGENT MASQUÉ. UNE FOIS LA CONSTRUCTION TERMINÉE, TOURNEZ LA MANIVELLE POUR VOIR LES GARDES MONTER LES MARCHES.
PLACE AU JEU.

¿HASTA DÓNDE ESTÁS DISPUESTO A LLEGAR PARA GANAR?

HAS VISTO A 456 JUGADORES LUCHAR POR UNA FORTUNA. ¡AHORA TE TOCA JUGAR A TI! RECREA LA ICÓNICA ESCALERA DE LA EXITOSA SERIE "EL JUEGO DEL CALAMAR", CON LOS TRABAJADORES Y EL ENIGMÁTICO LÍDER. SAL DE LA EDIFICACIÓN GIRANDO LA MANIVELA PARA VER A LOS TRABAJADORES SUBIR LOS ESCALONES.
QUE EMPIECE EL JUEGO.

ATÉ ONDE VOCÊ QUER IR PARA VENCER?

VISTE 456 JOGADORES A LUTAR PARA CONSEGUIR UMA FORTUNA. AGORA, É A TUA VEZ DE JOGAR. RECRIA A ICÓNICA ESCADARIA DA SÉRIE DE SUCESSO SQUID GAME, COMPLETA COM TRABALHADORES E O ENIGMÁTICO APRESENTADOR. RETIRA A TAMPA DO EDIFÍCIO AO RODAR A MANIVELA, PARA VERES OS TRABALHADORES A SUBIREM OS DEGRAUS.
QUE OS JOGOS COMECEM.

WIE WEIT BIST DU BEREIT FÜR DEN SIEG ZU GEHEN?

456 SPIELER HABEN UM EIN VERMÖGEN GEKÄMPFT. JETZT BIST DU AN DER REIHE. DIE IKONISCHE TREPPE AUS DER ERFOLGSSERIE SQUID GAME KOMPLETT MIT ARBEITERN UND DEM RÄTSELHAFTEN VORARBEITER NACHBILDEN. UM DAS GEBÄUDE ABZUSCHLIEßEN, DIE KURBEL DREHEN, DAMIT DIE ARBEITER DIE TREPPE HINAUFSTEIGEN KÖNNEN.
LASST DIE SPIELE BEGINNEN.

Как далеко вы готовы зайти ради победы?

Вы видели, как 456 игроков сражались за состояние. Пришла ваша очередь играть. Воссоздайте легендарную лестницу из популярного сериала "Игра в кальмара", дополнив ее рабочими и загадочным Фронтменом.
Завершите свое здание, повернув рукоятку, чтобы увидеть, как рабочие поднимаются по ступеням.
Да начнется игра.

QUID
FAME

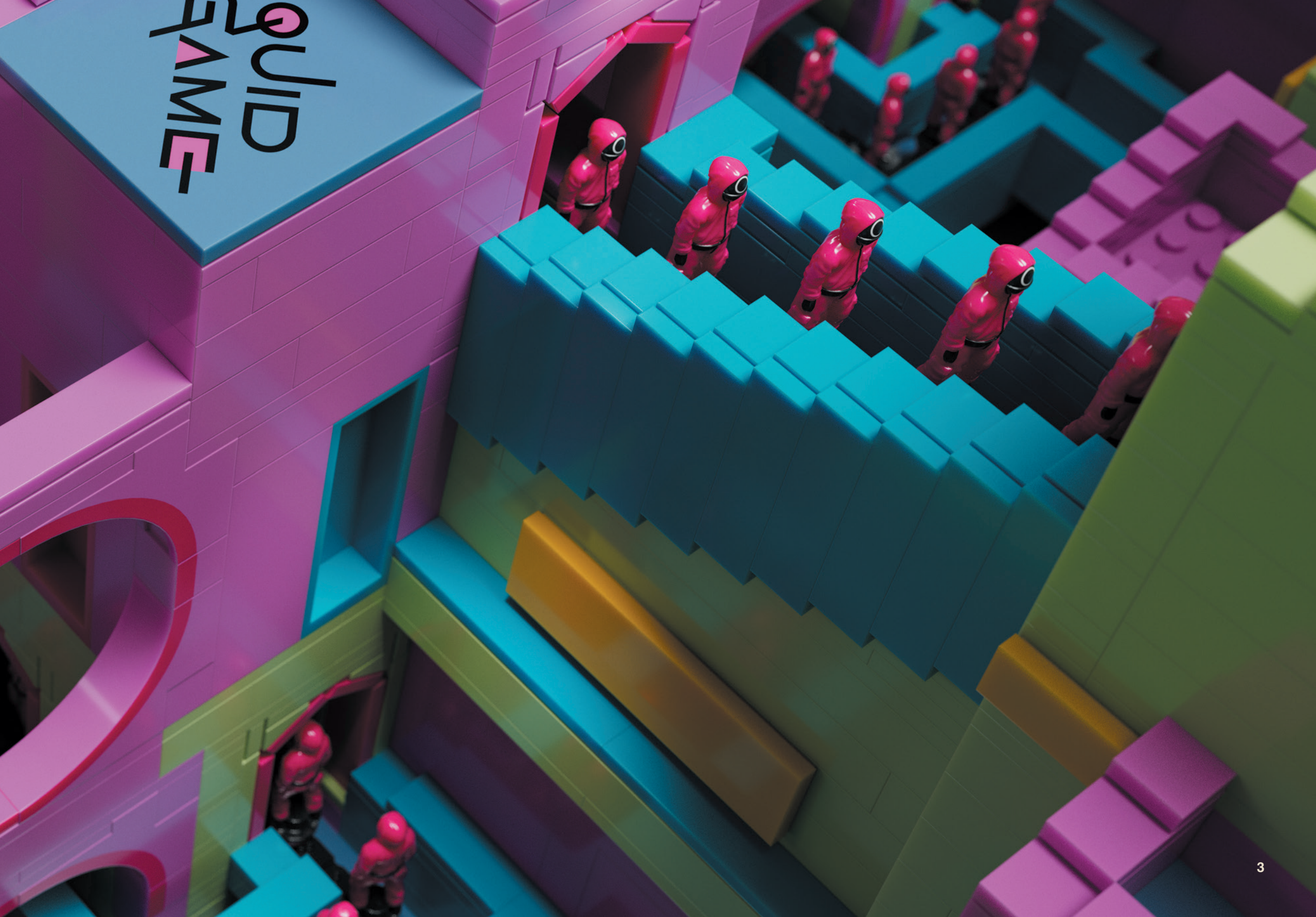

2

BUILDING TOOL
OUTIL DE CONSTRUCTION

HERRAMIENTA DE CONSTRUCCIÓN
FERRAMENTA DE MONTAGEM
BAUWERKZEUG
ИНСТРУМЕНТ ДЛЯ КОНСТРУИРОВАНИЯ

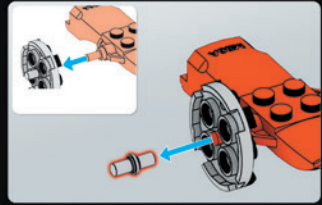
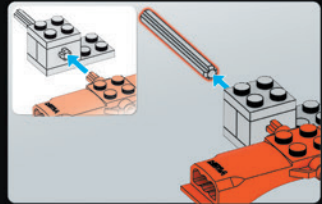
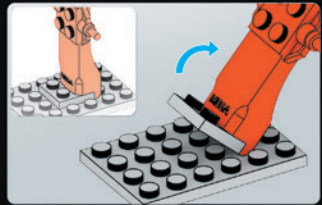
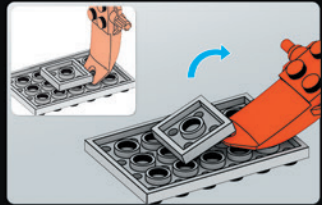
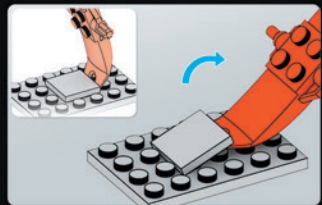
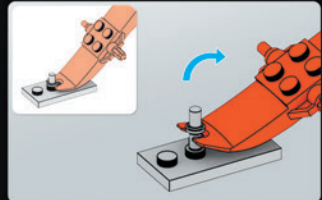

001

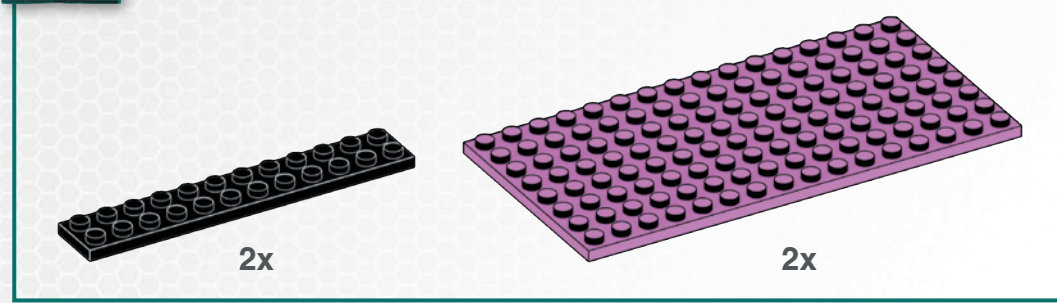

2x

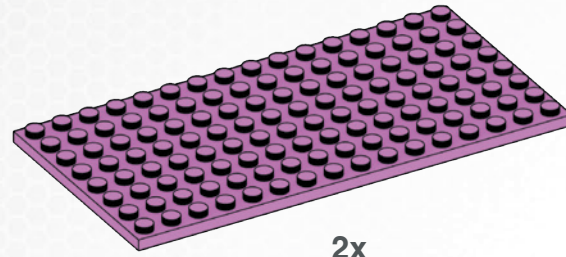

2x

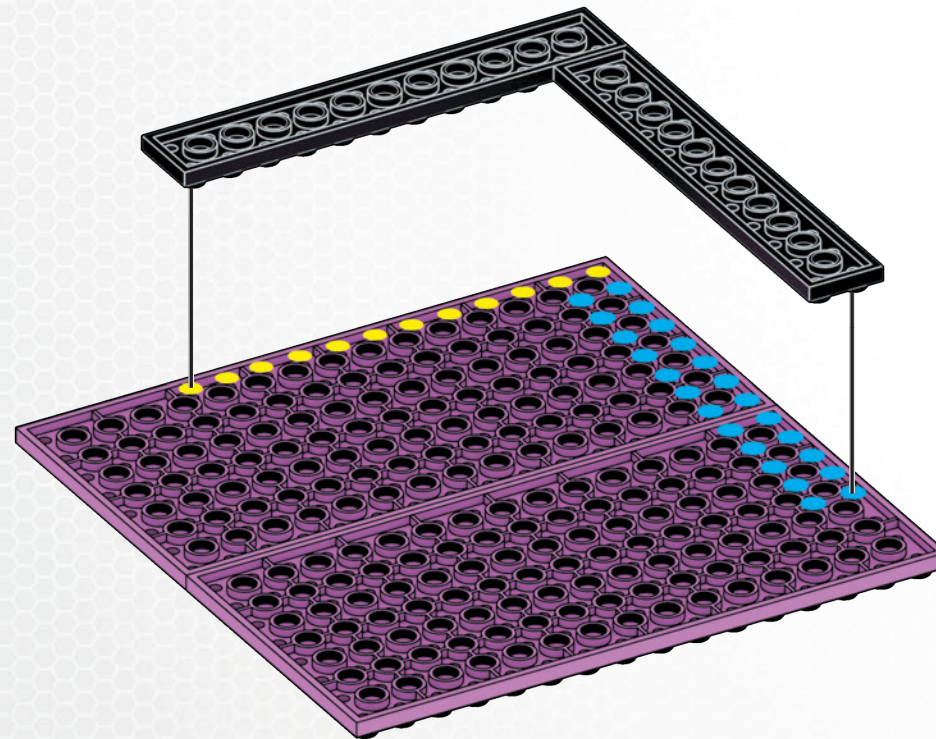

002



3x

2x

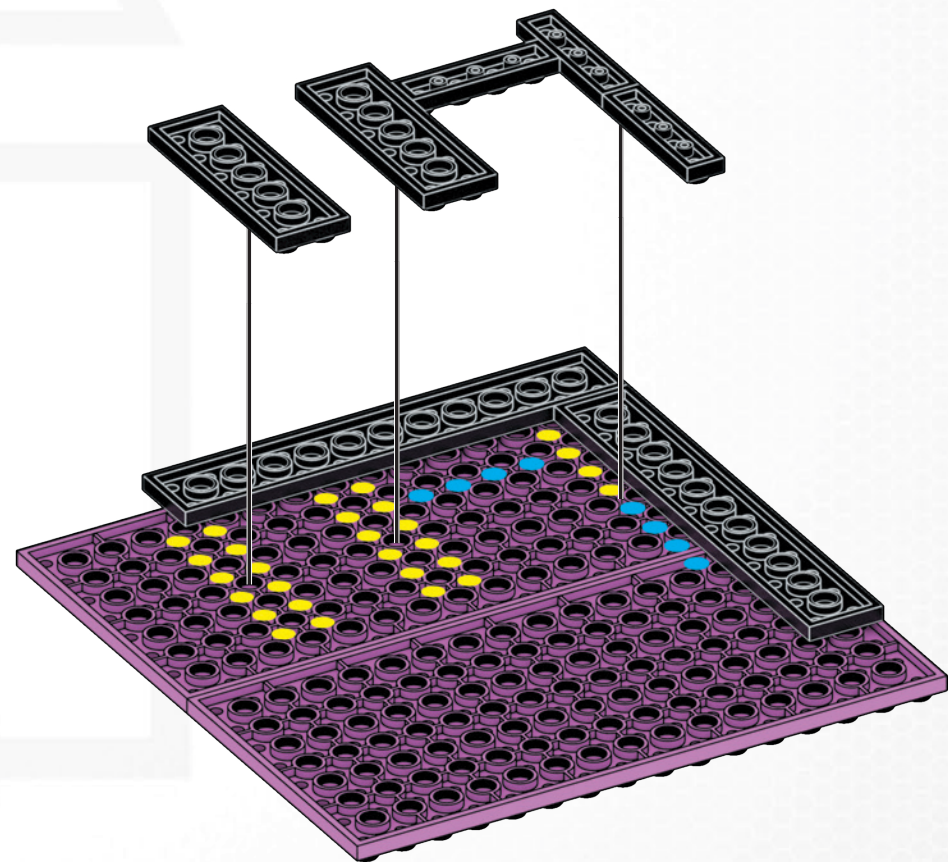

003



2x

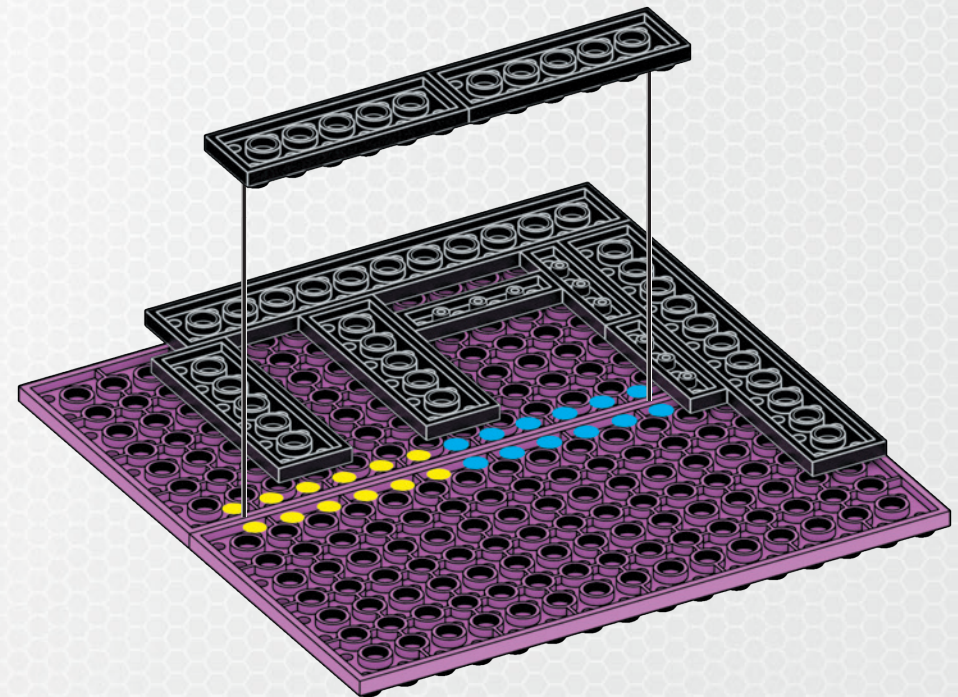

004

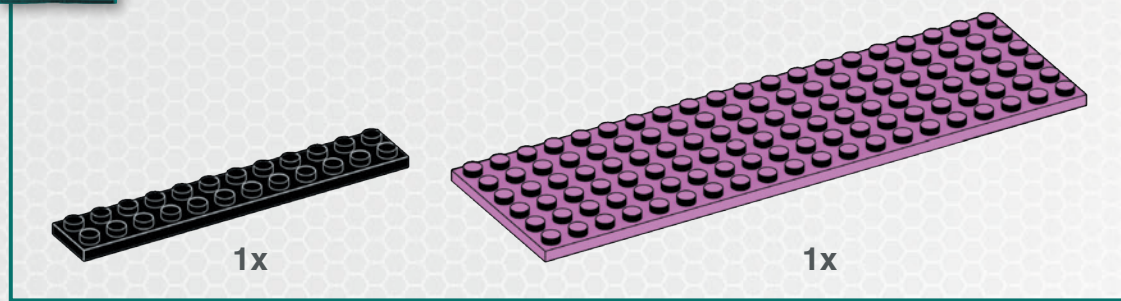

005

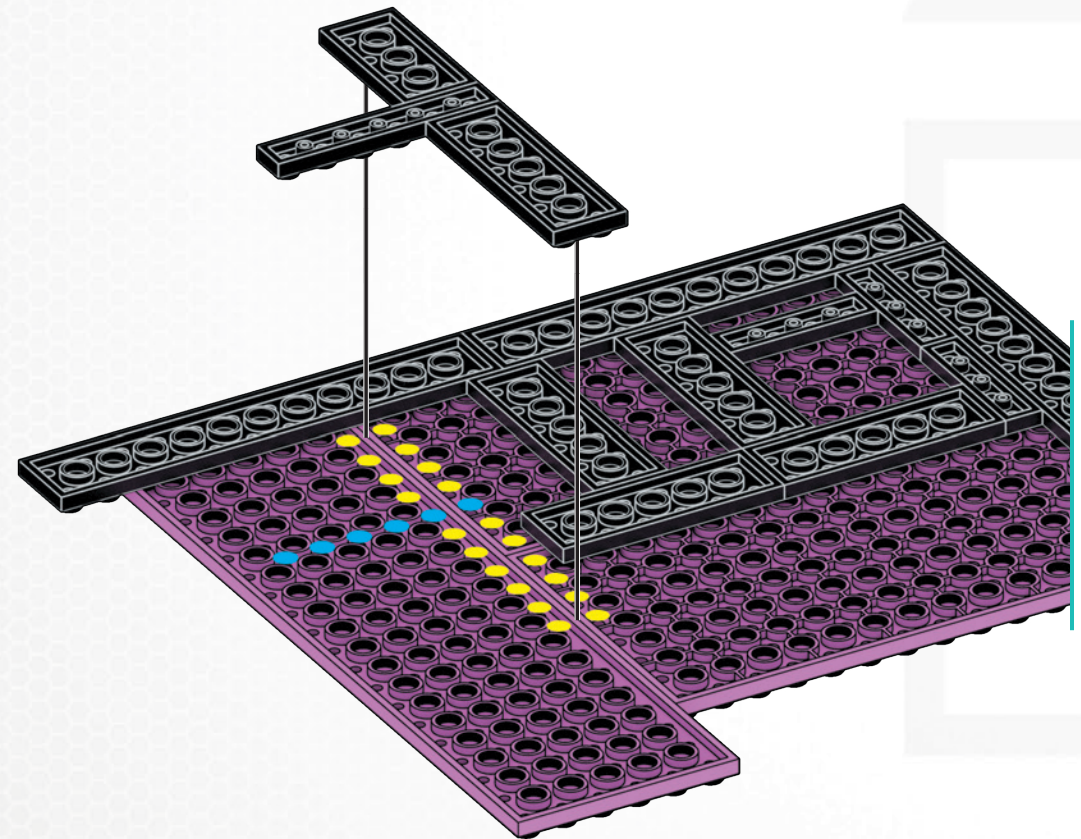
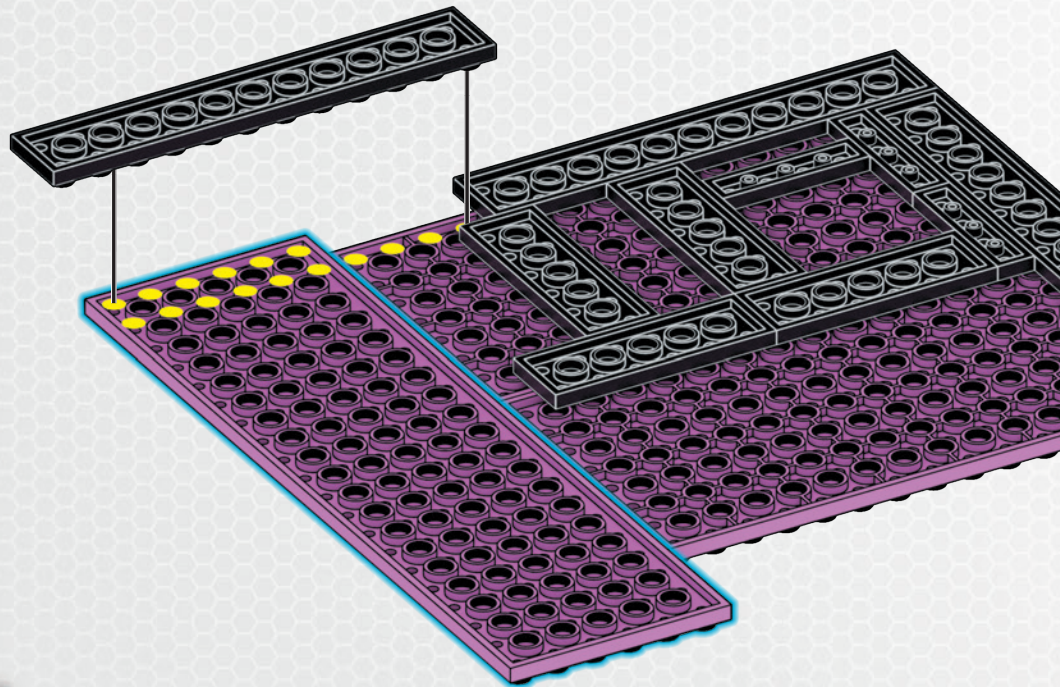
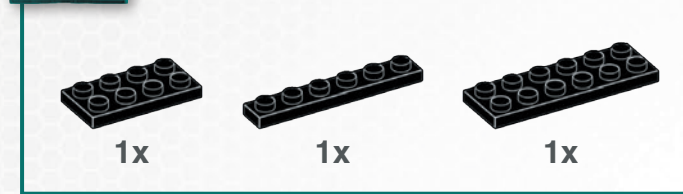

006



2x

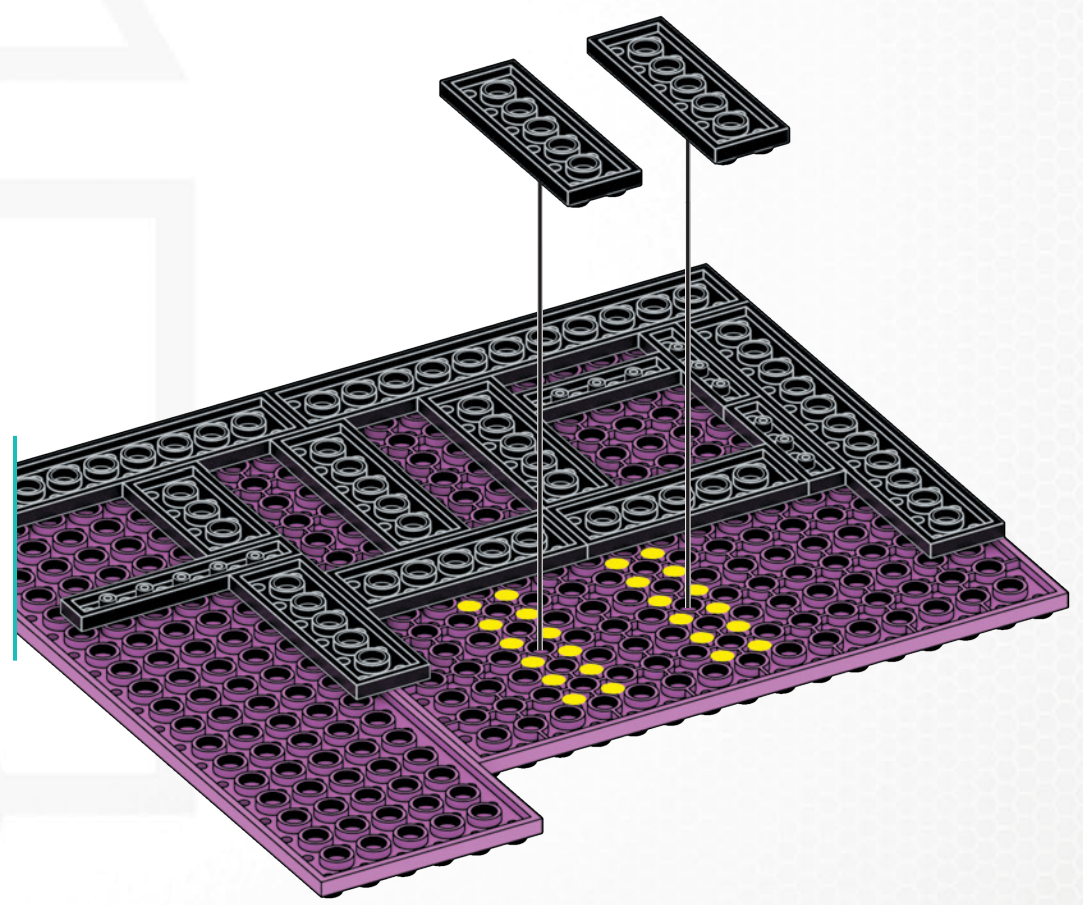

007



1x

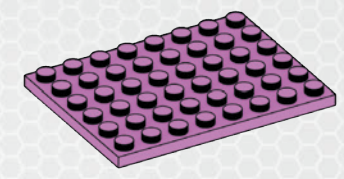

1x

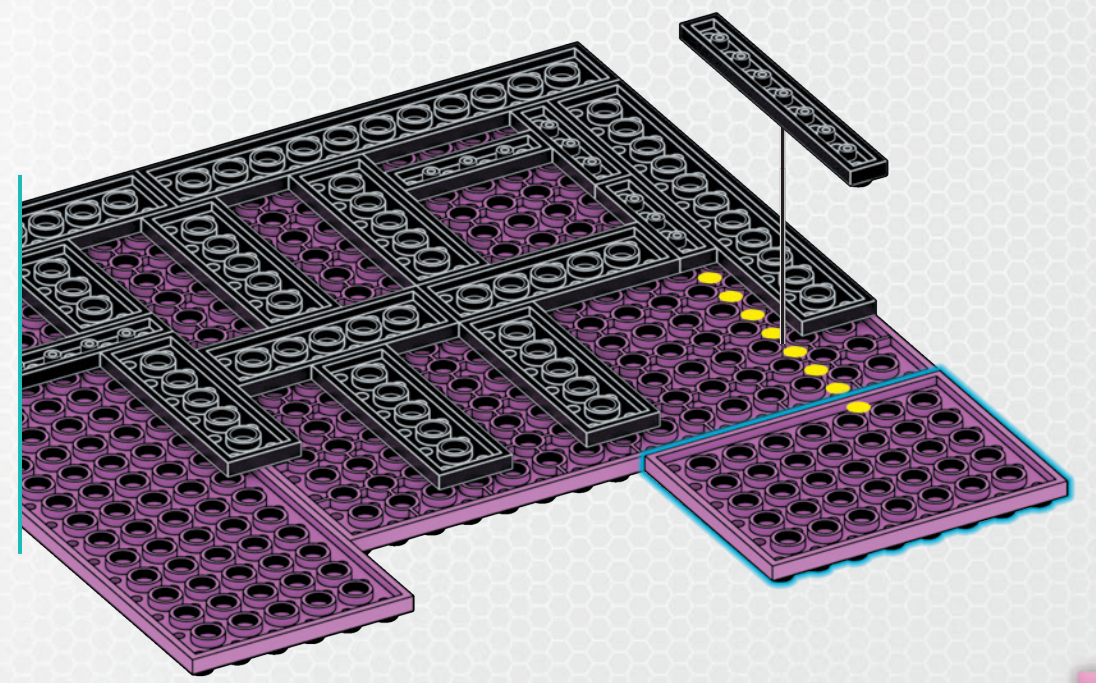

008

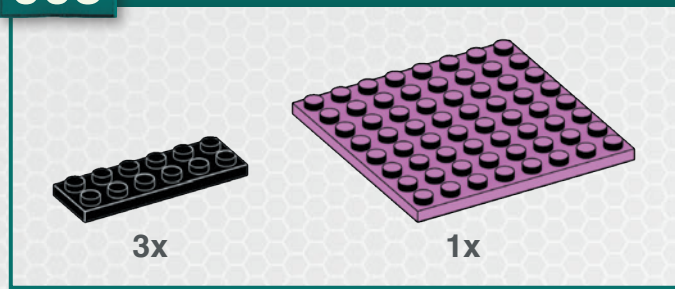

009

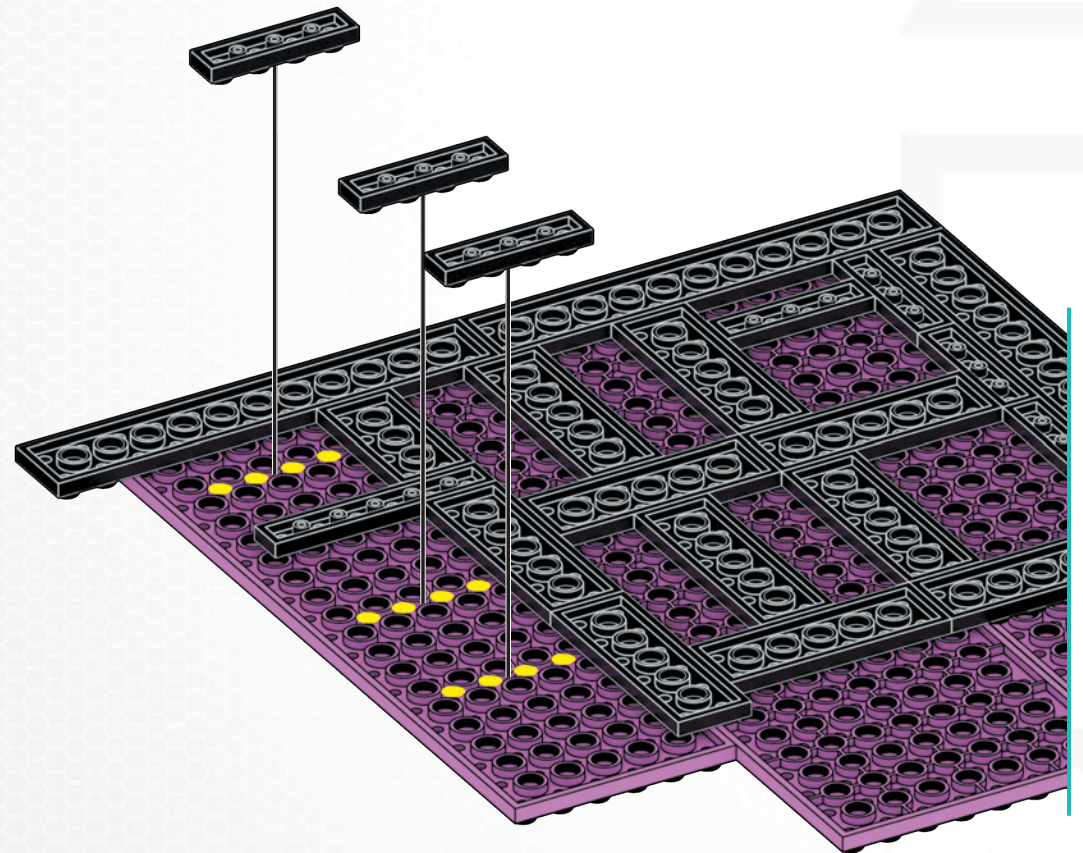
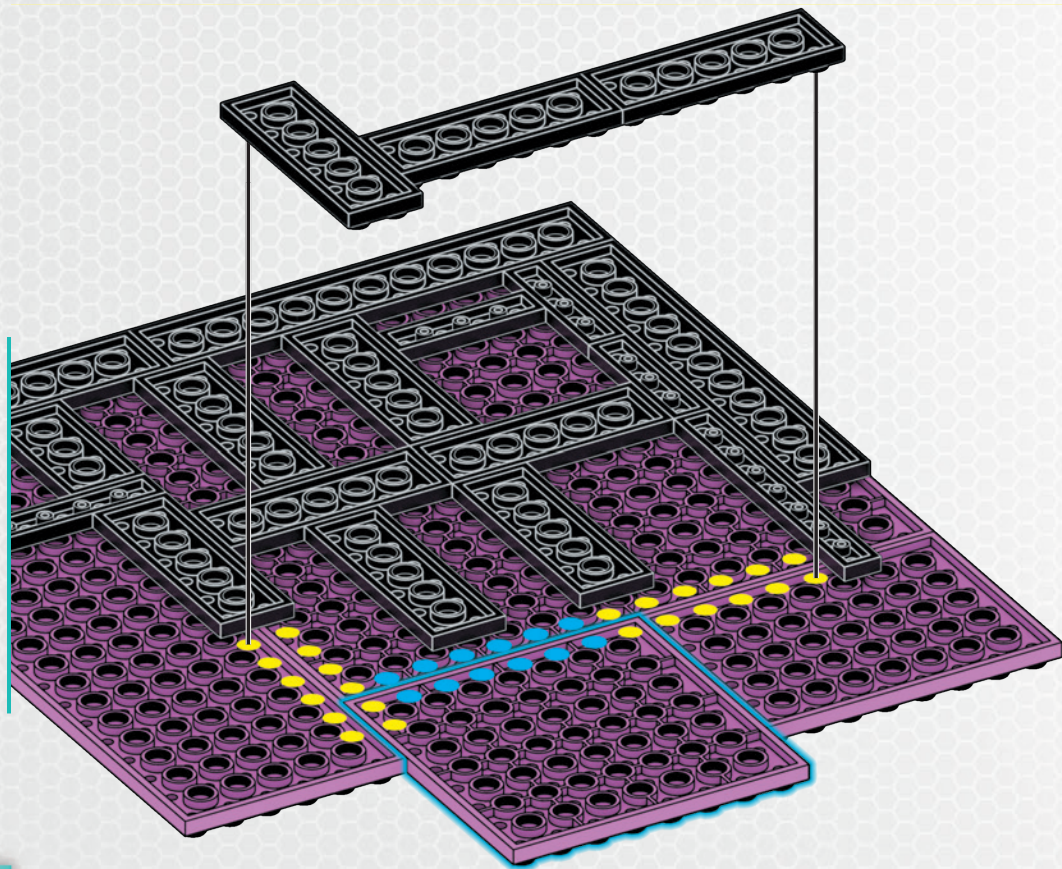

010



1x



1x

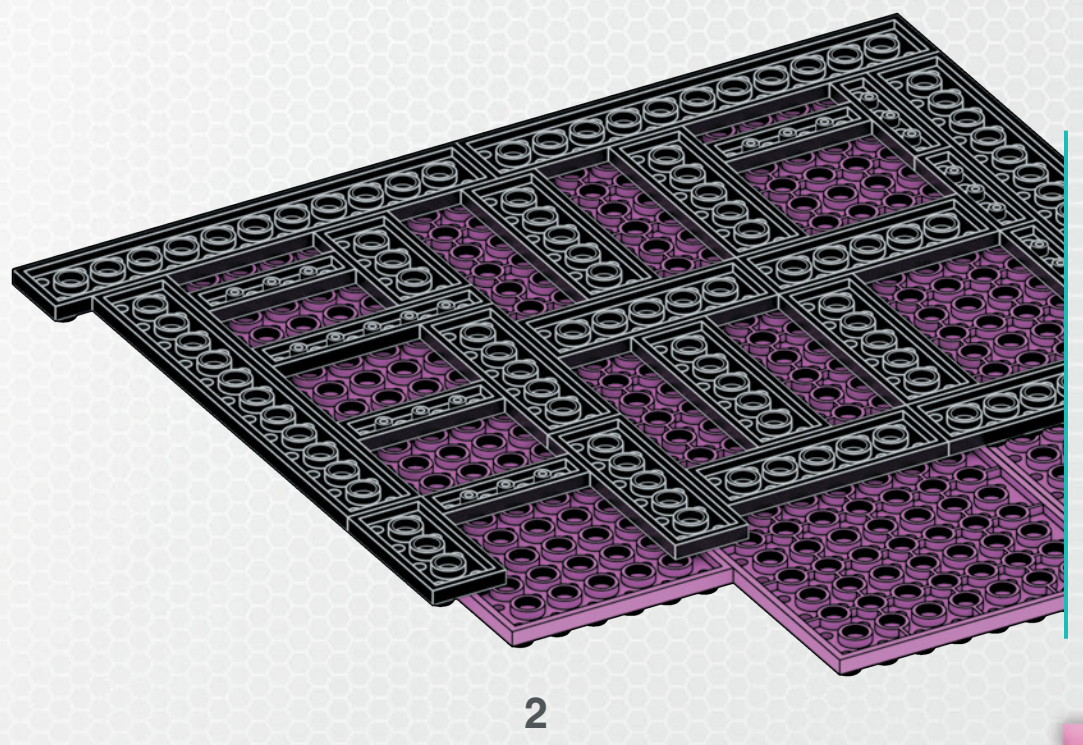
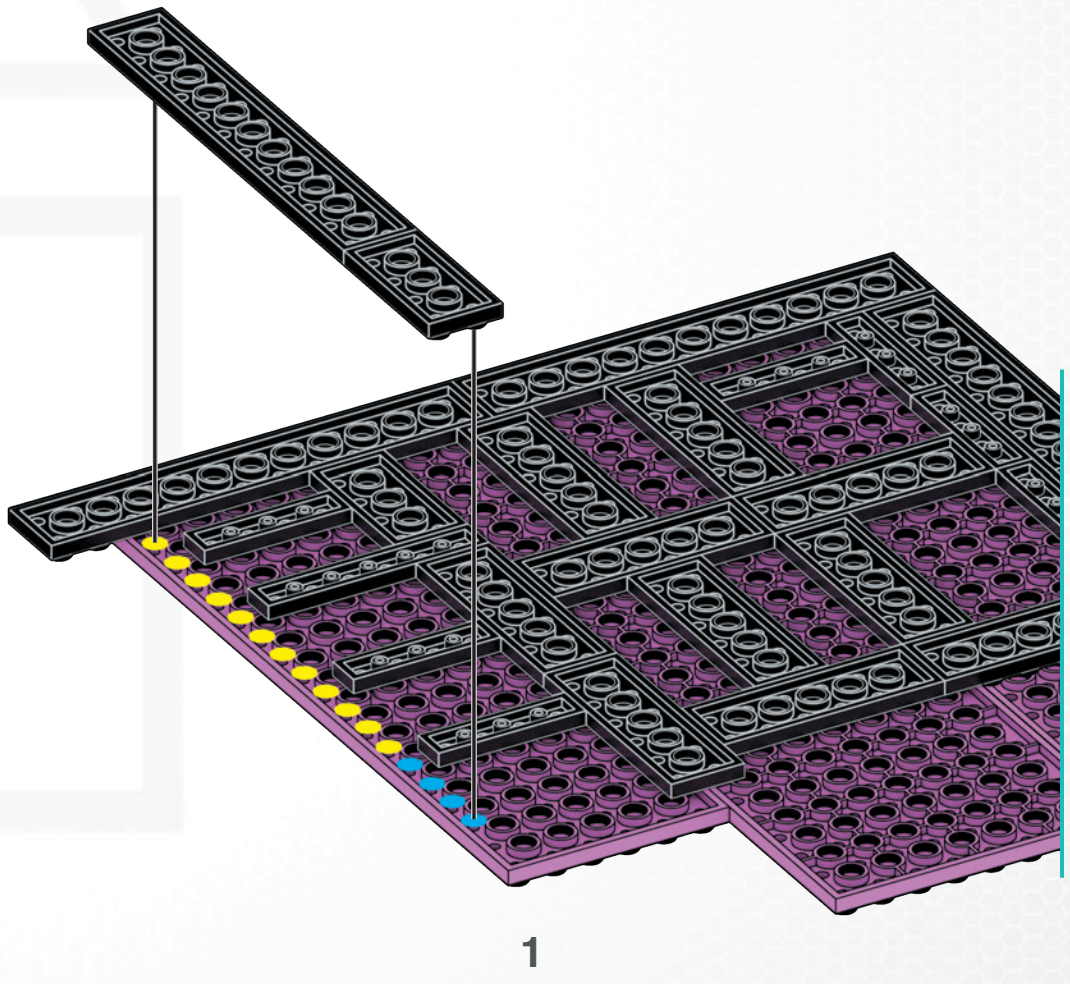

011



2x

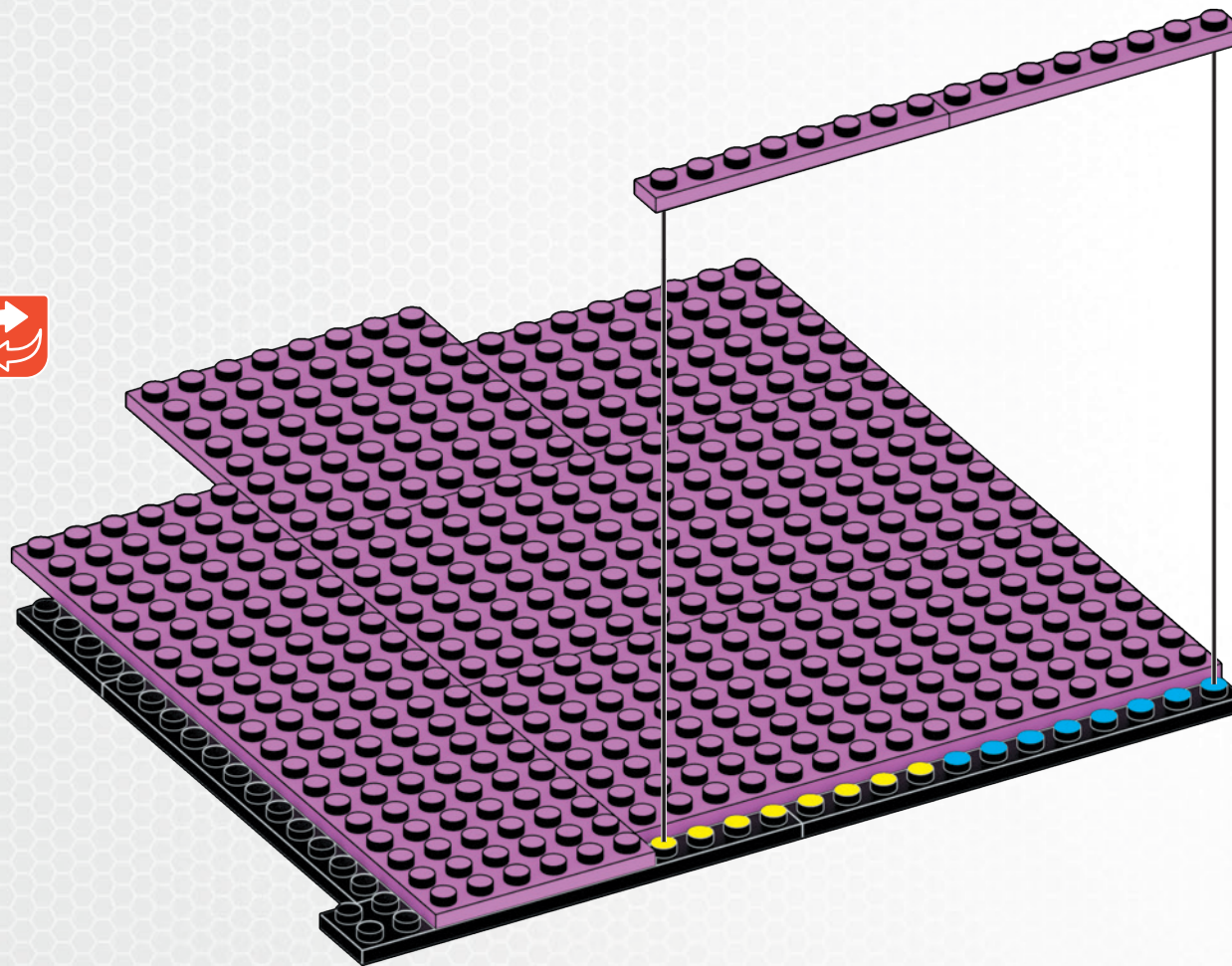

013



1x

014



1x



1x

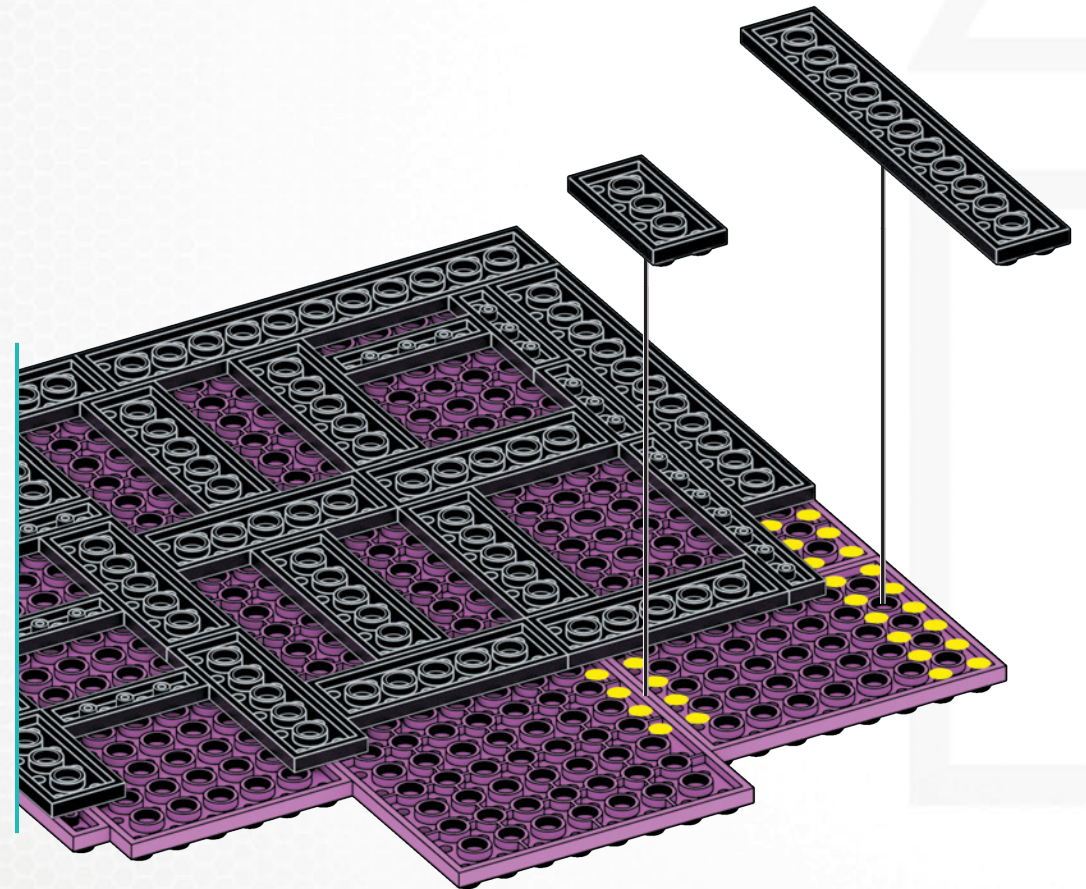
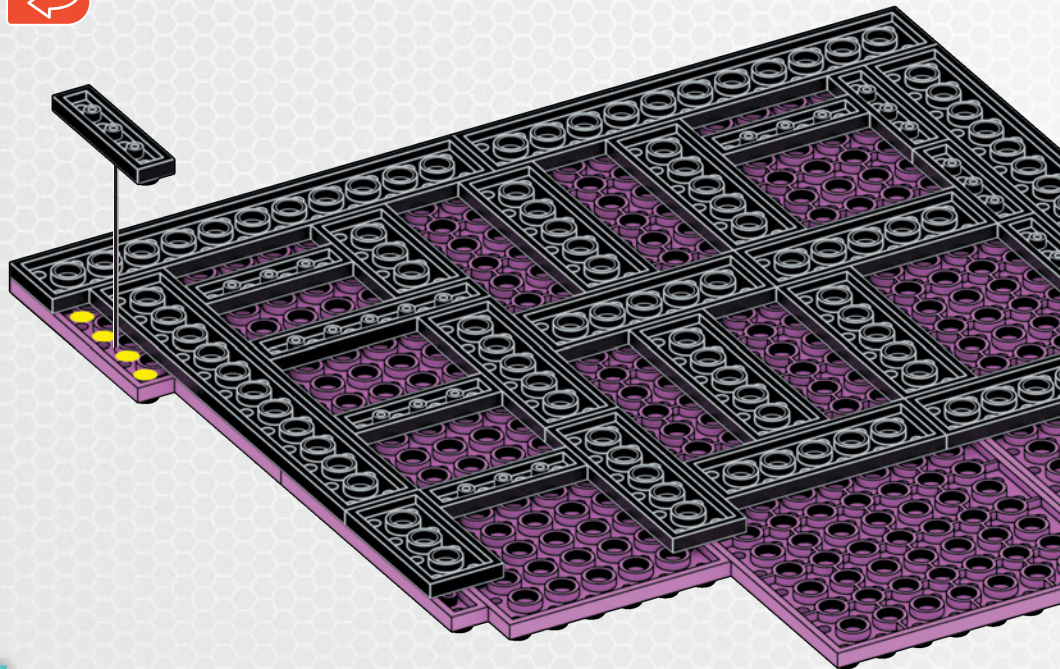

015

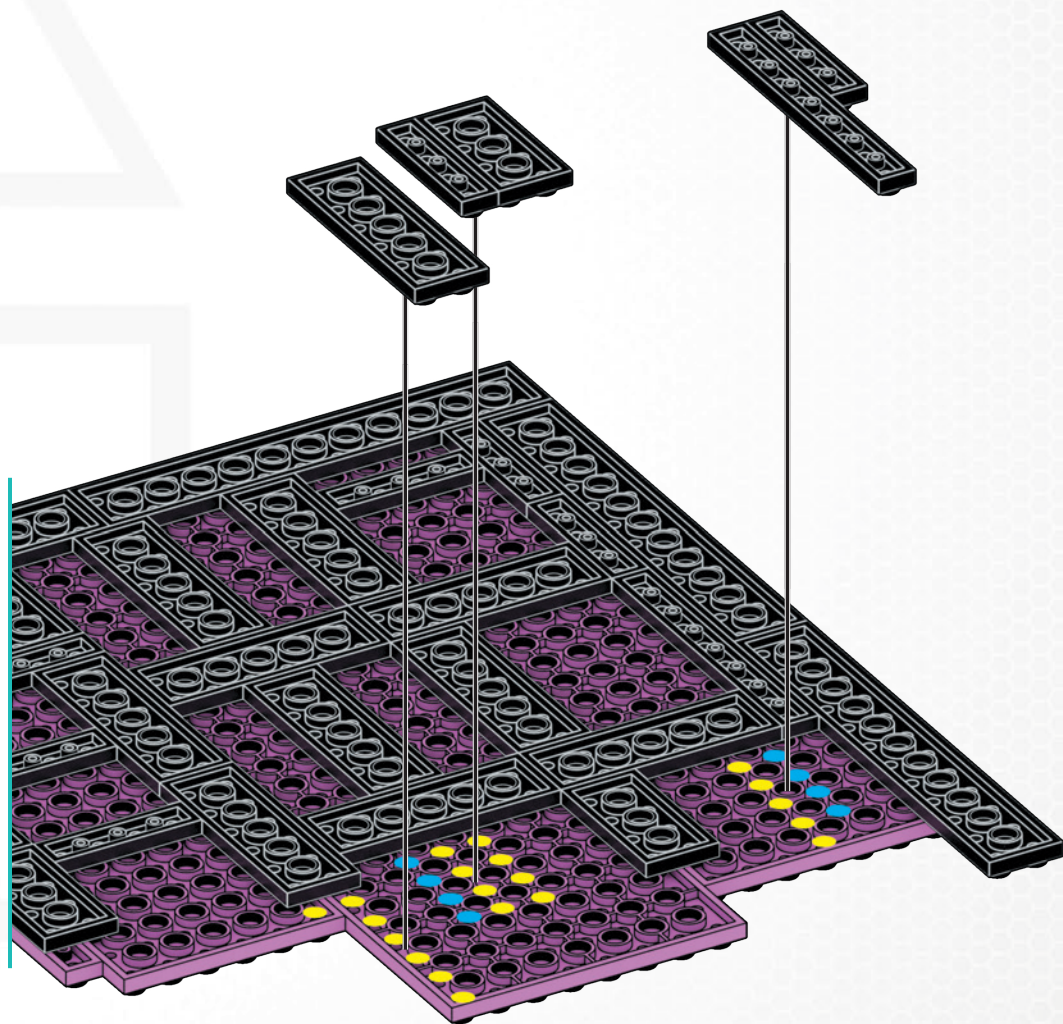

016

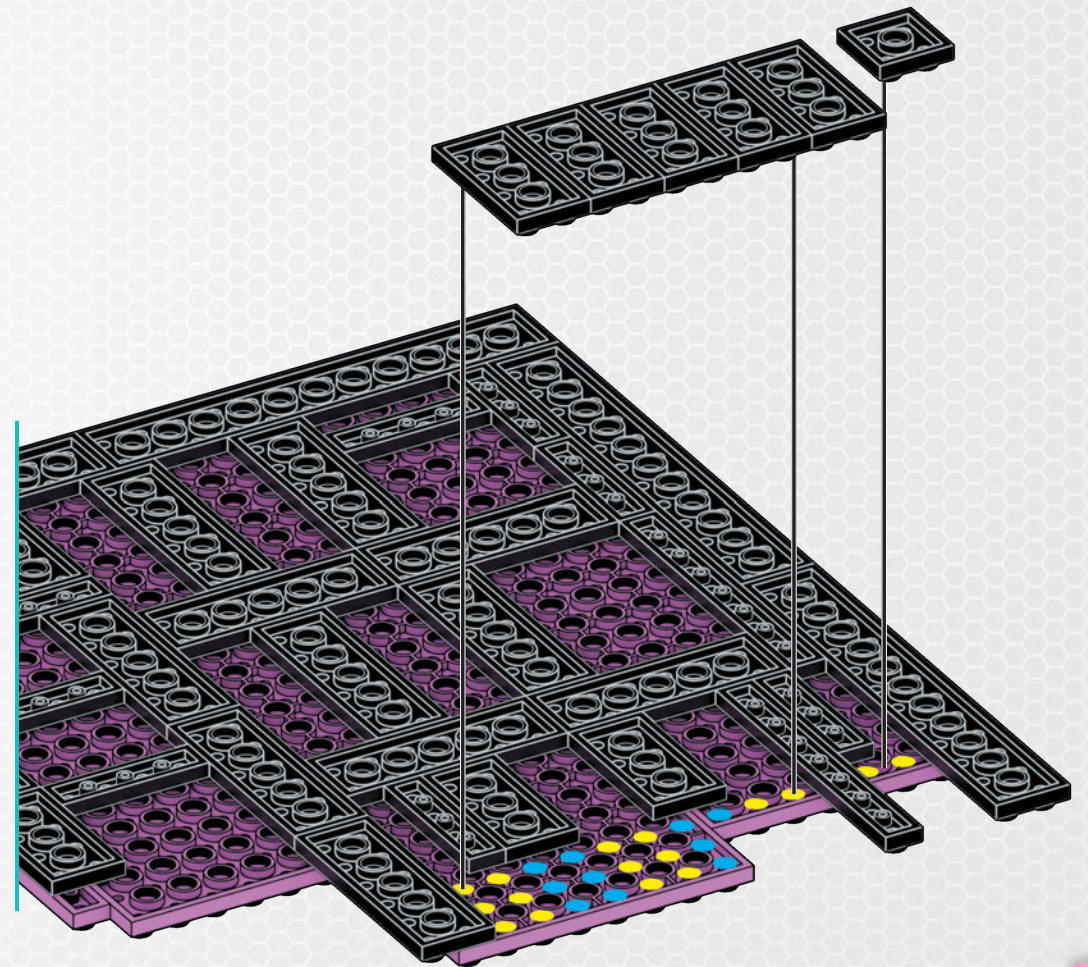

017



1x



1x



1x



1x



1x

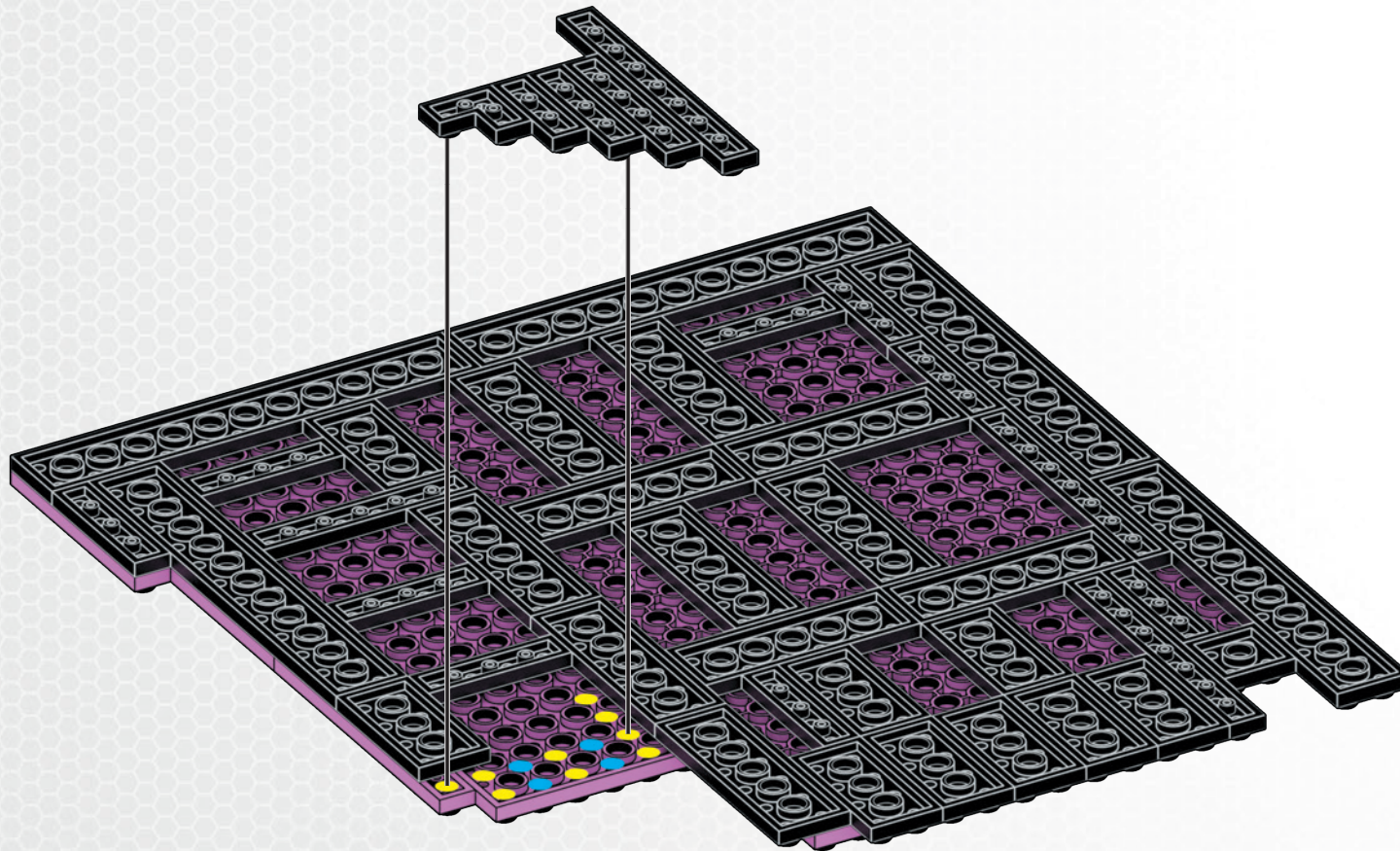

018



4x

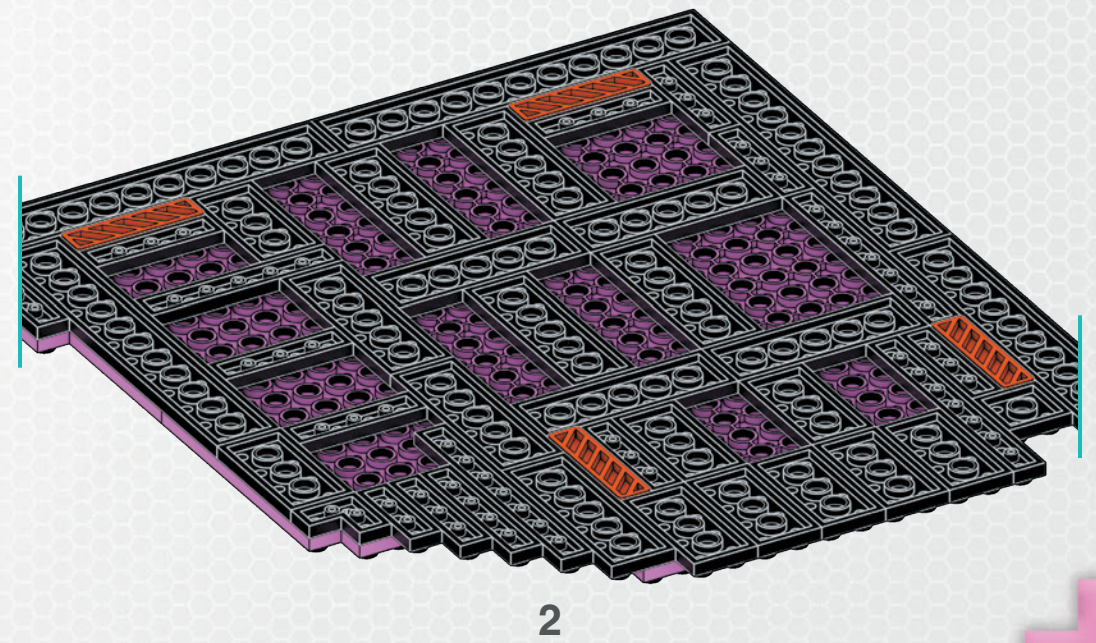
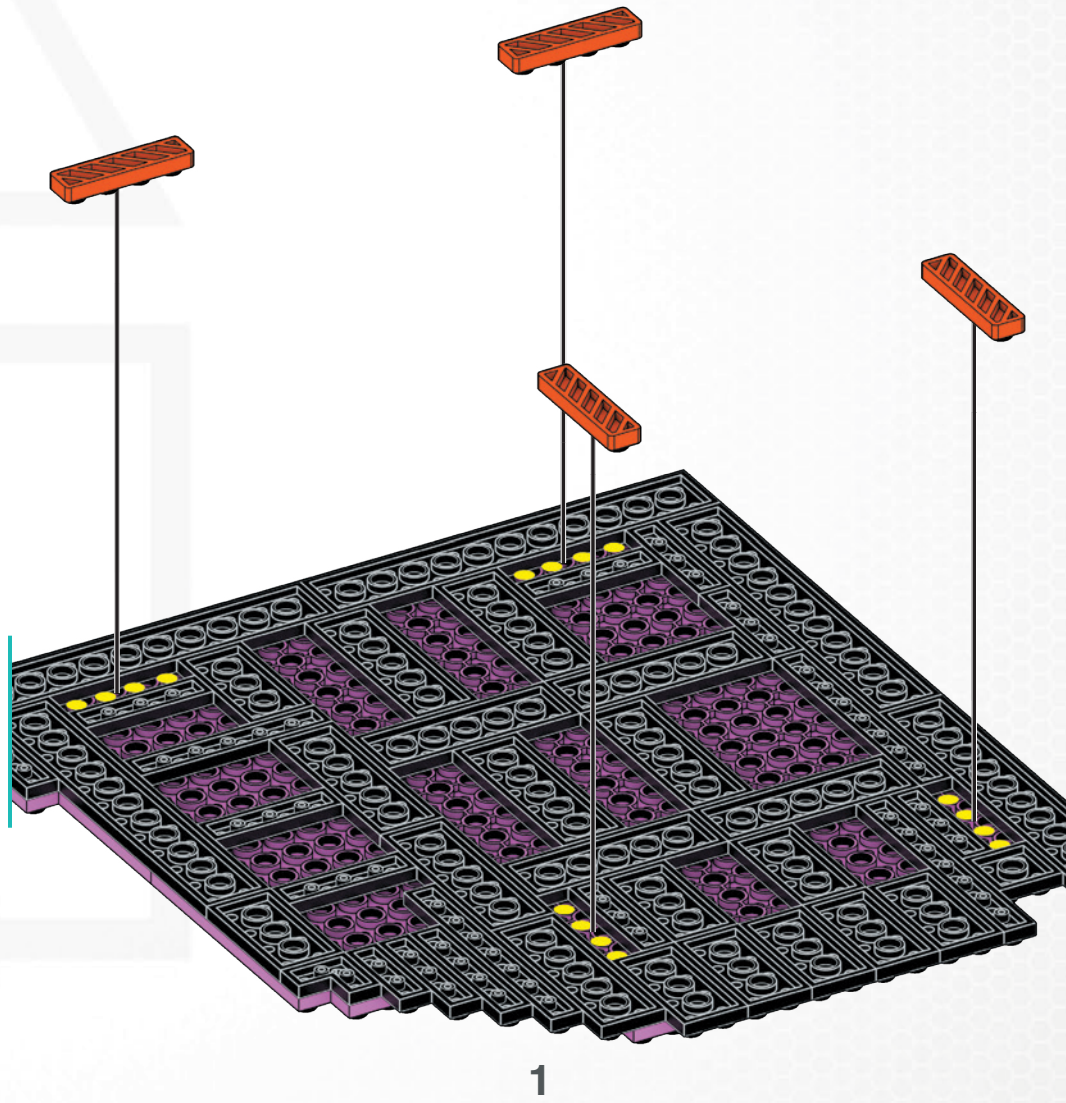

019

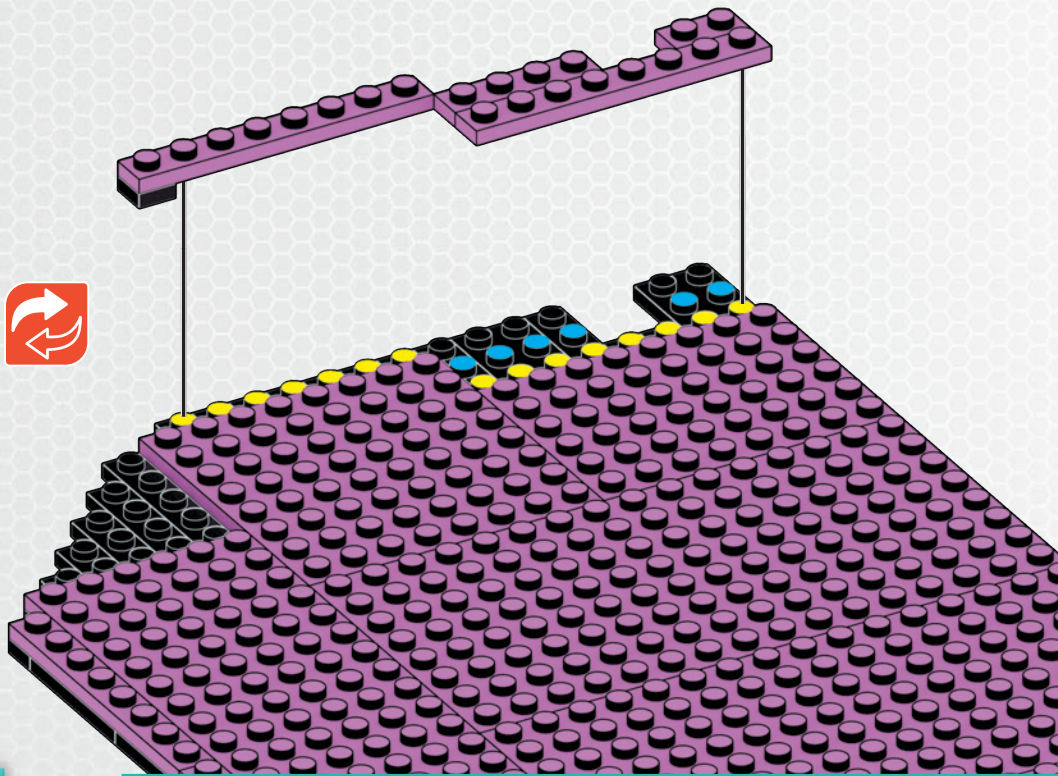
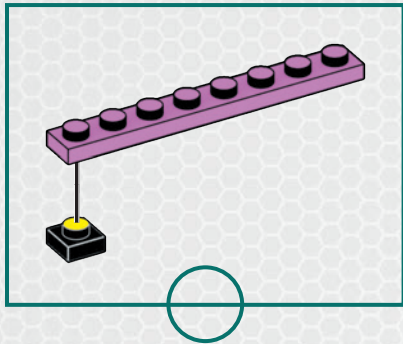
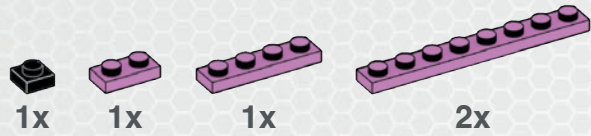

020

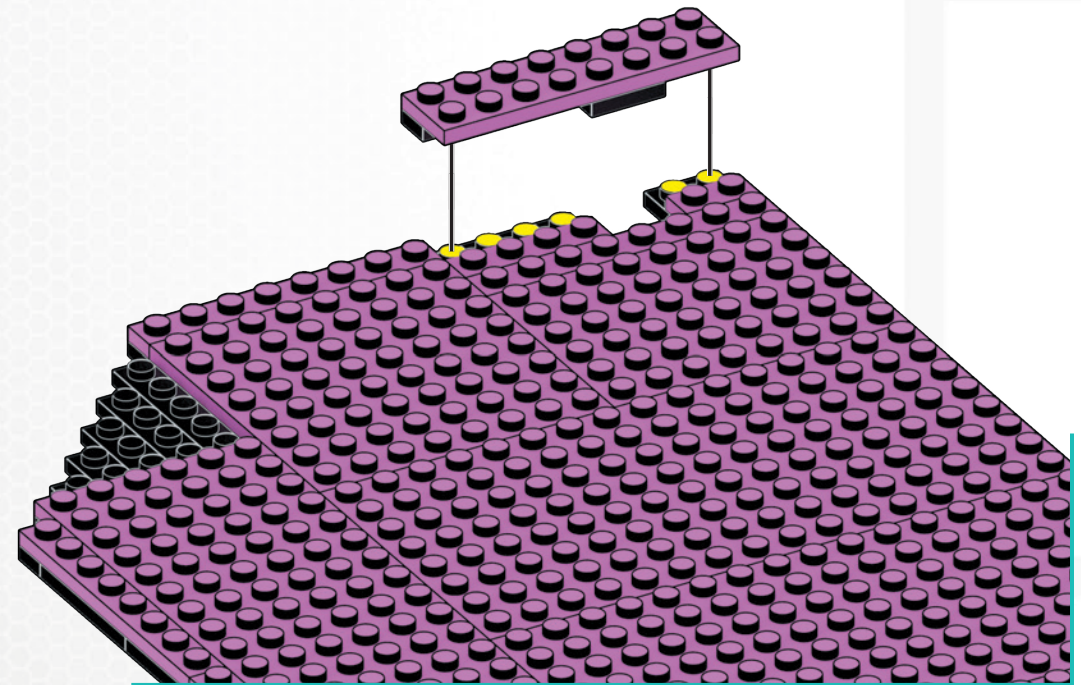
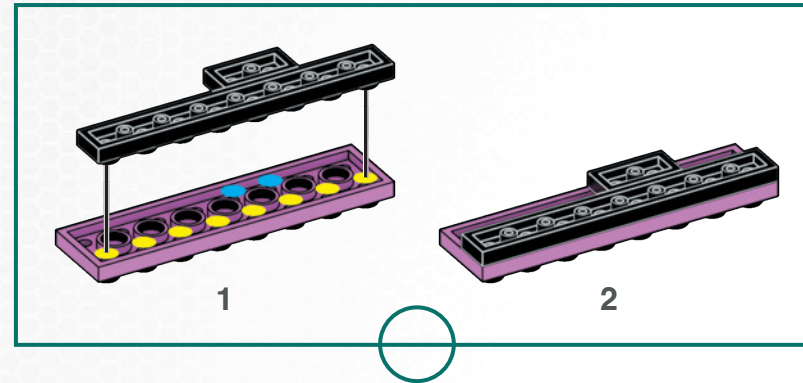

021

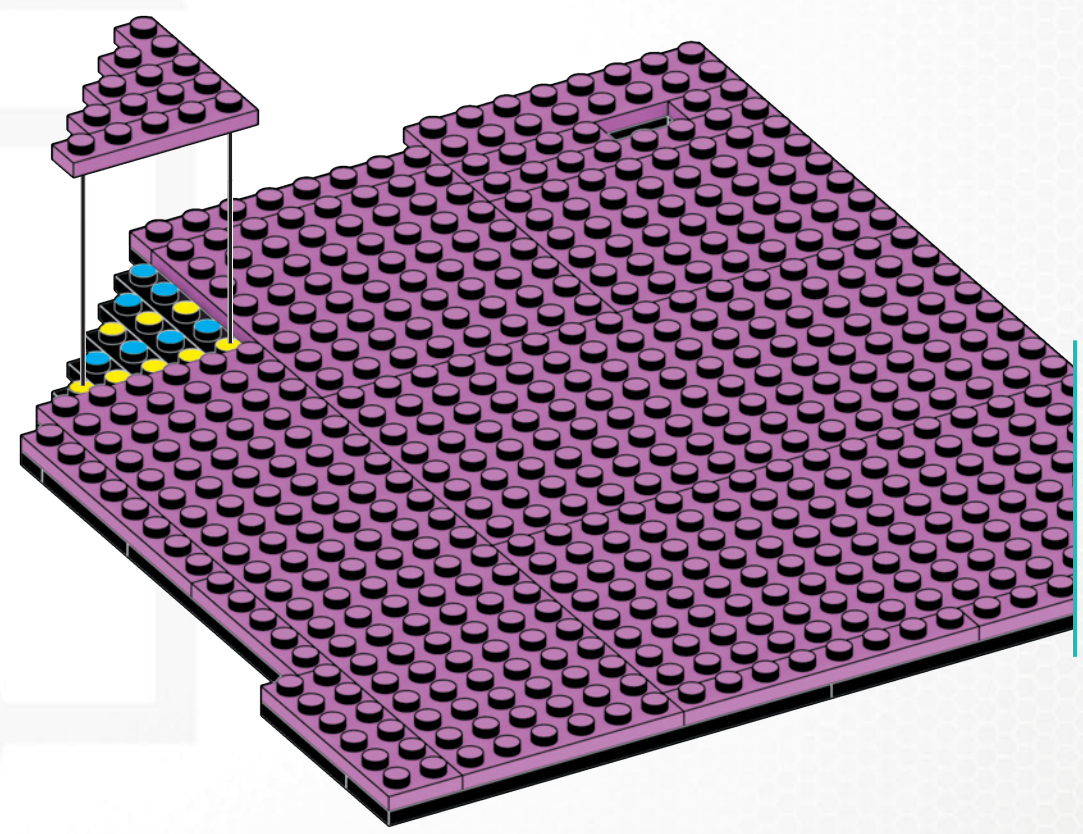
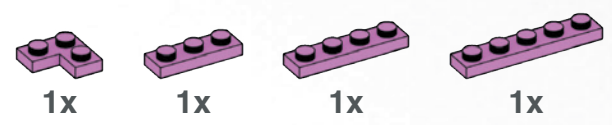

022

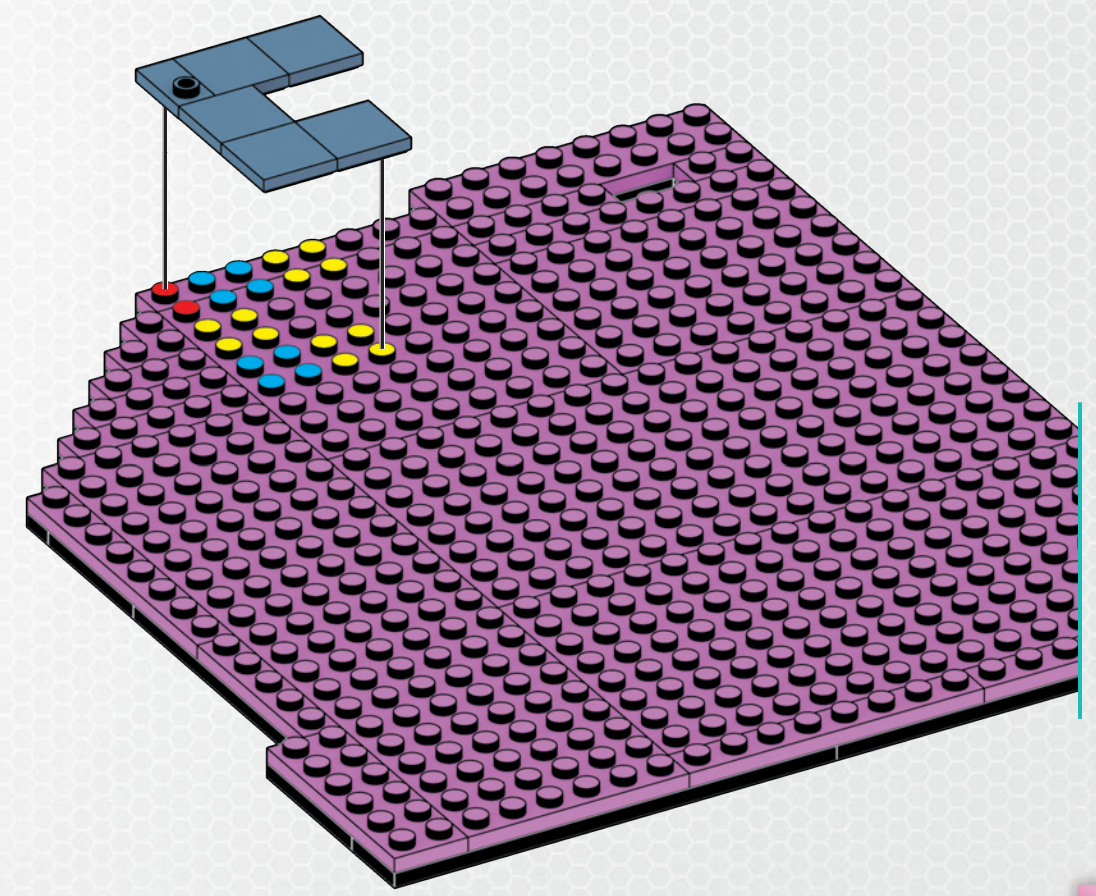
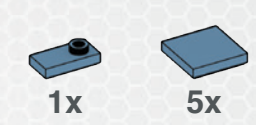

023

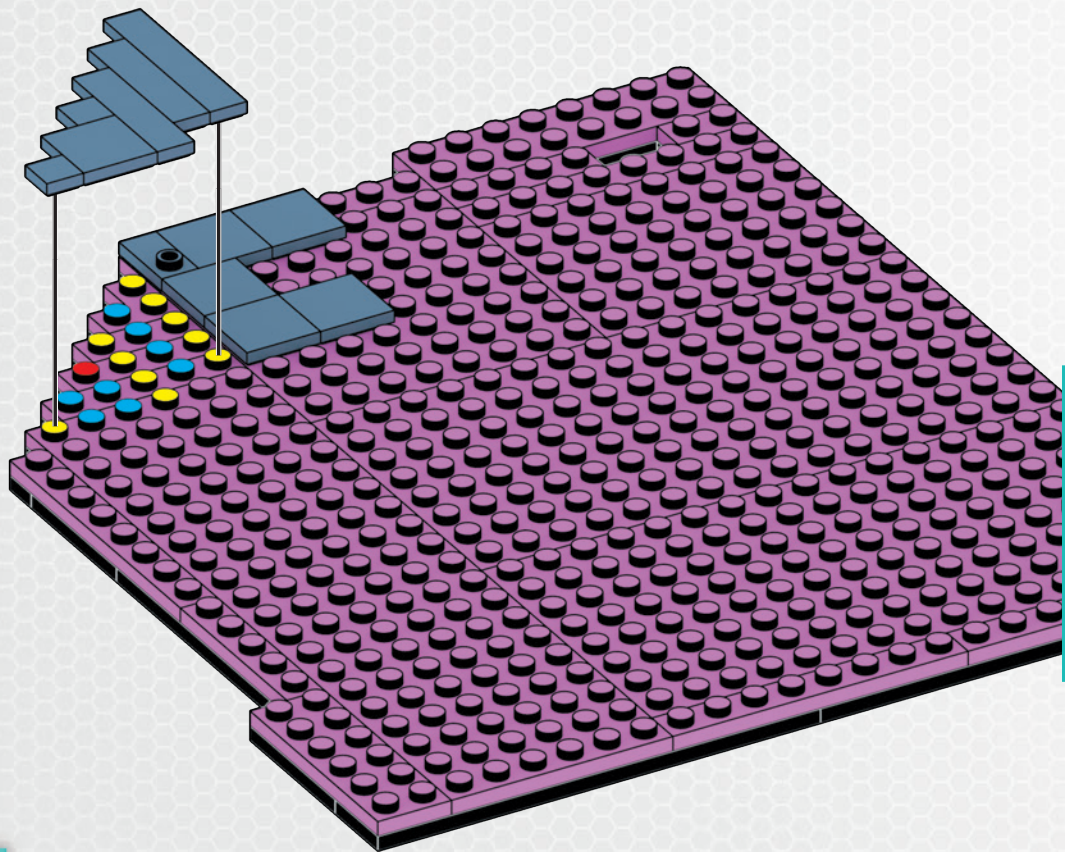
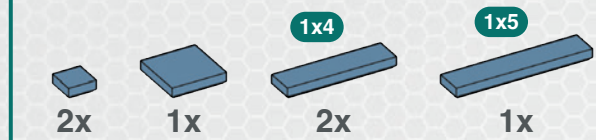

024

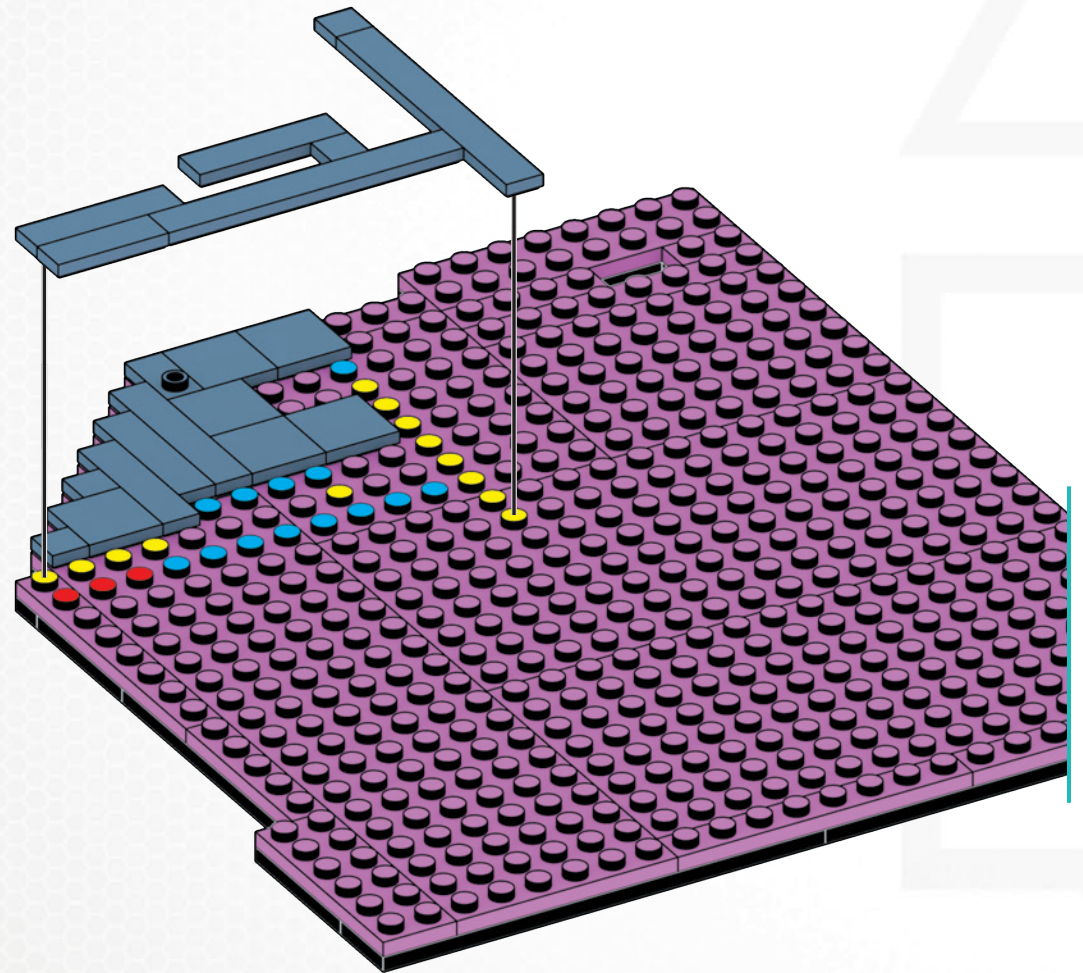
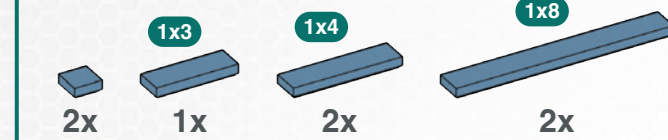

025

3x3

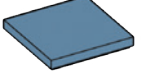

1x

1x5



1x

2x6



2x

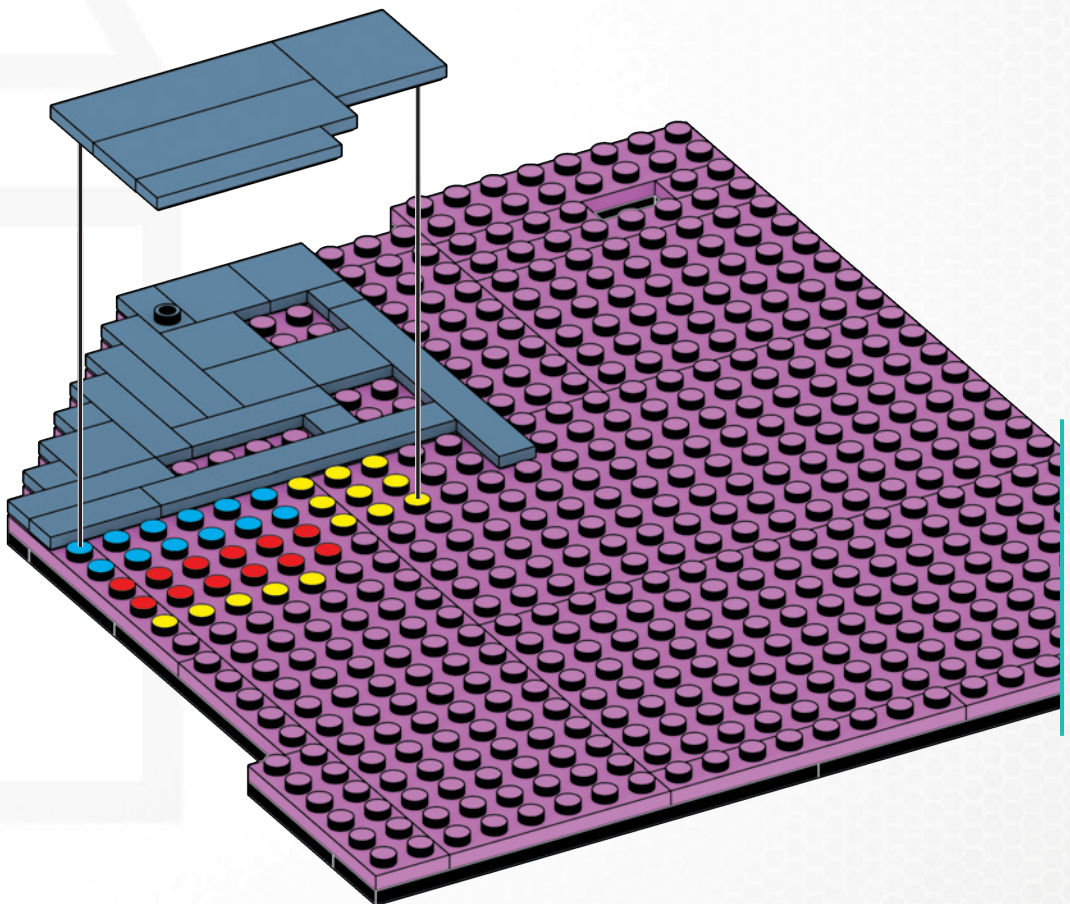

026



1x



1x



2x



1x

1x4



1x

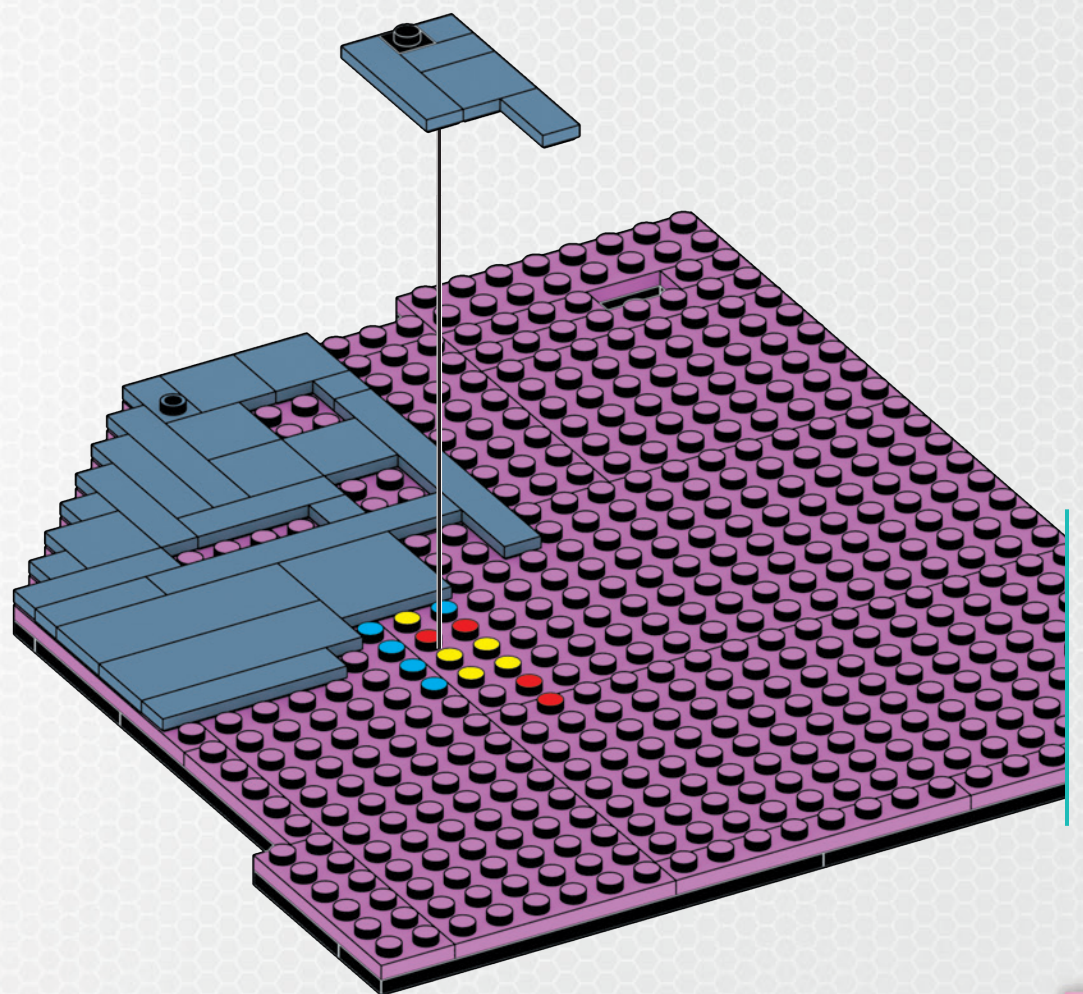

027

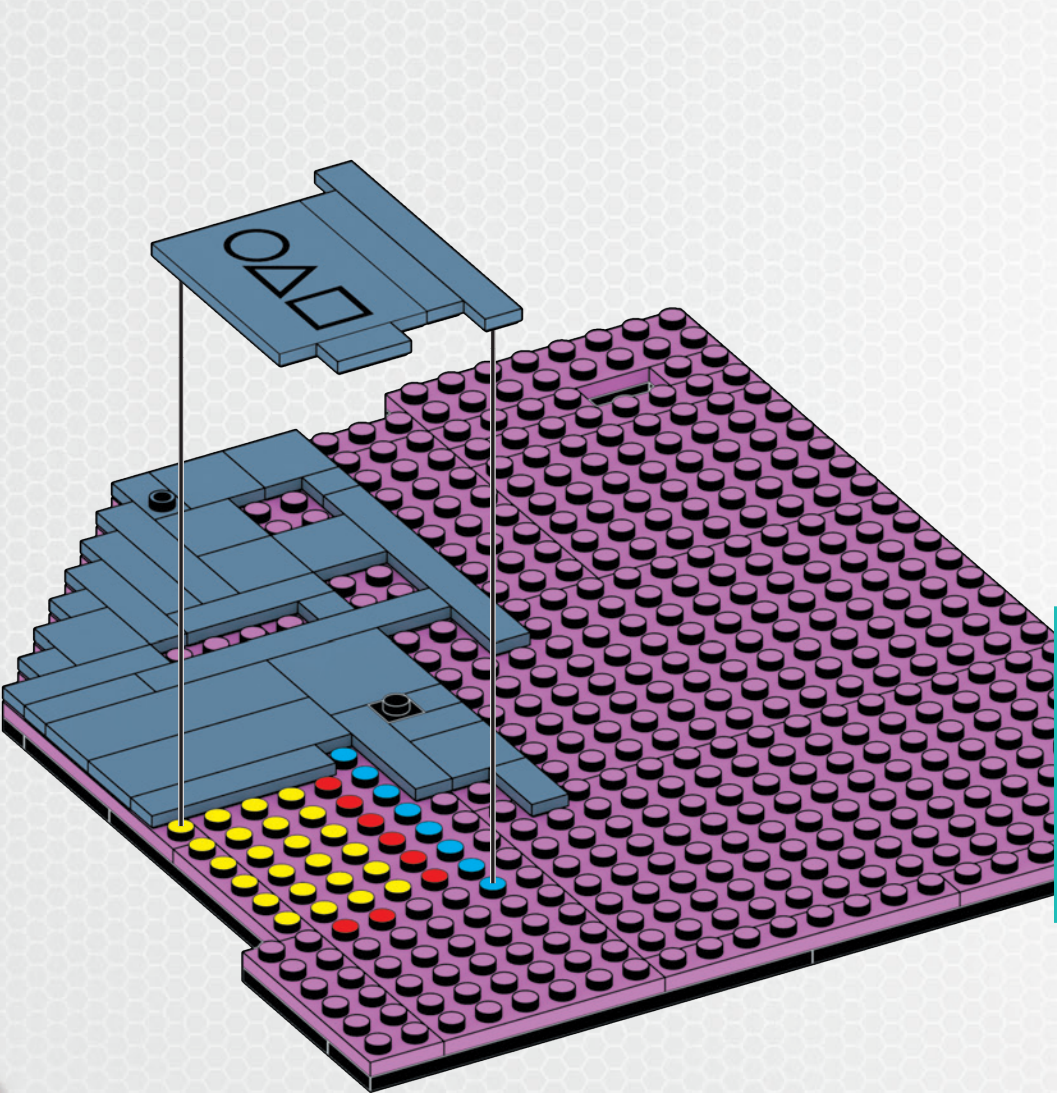
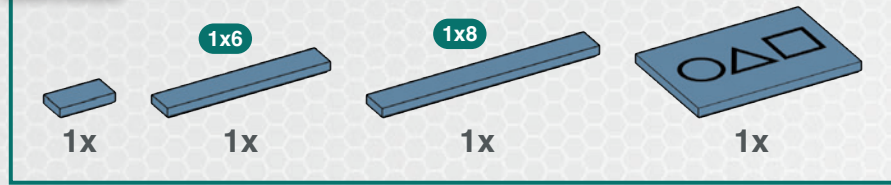

028

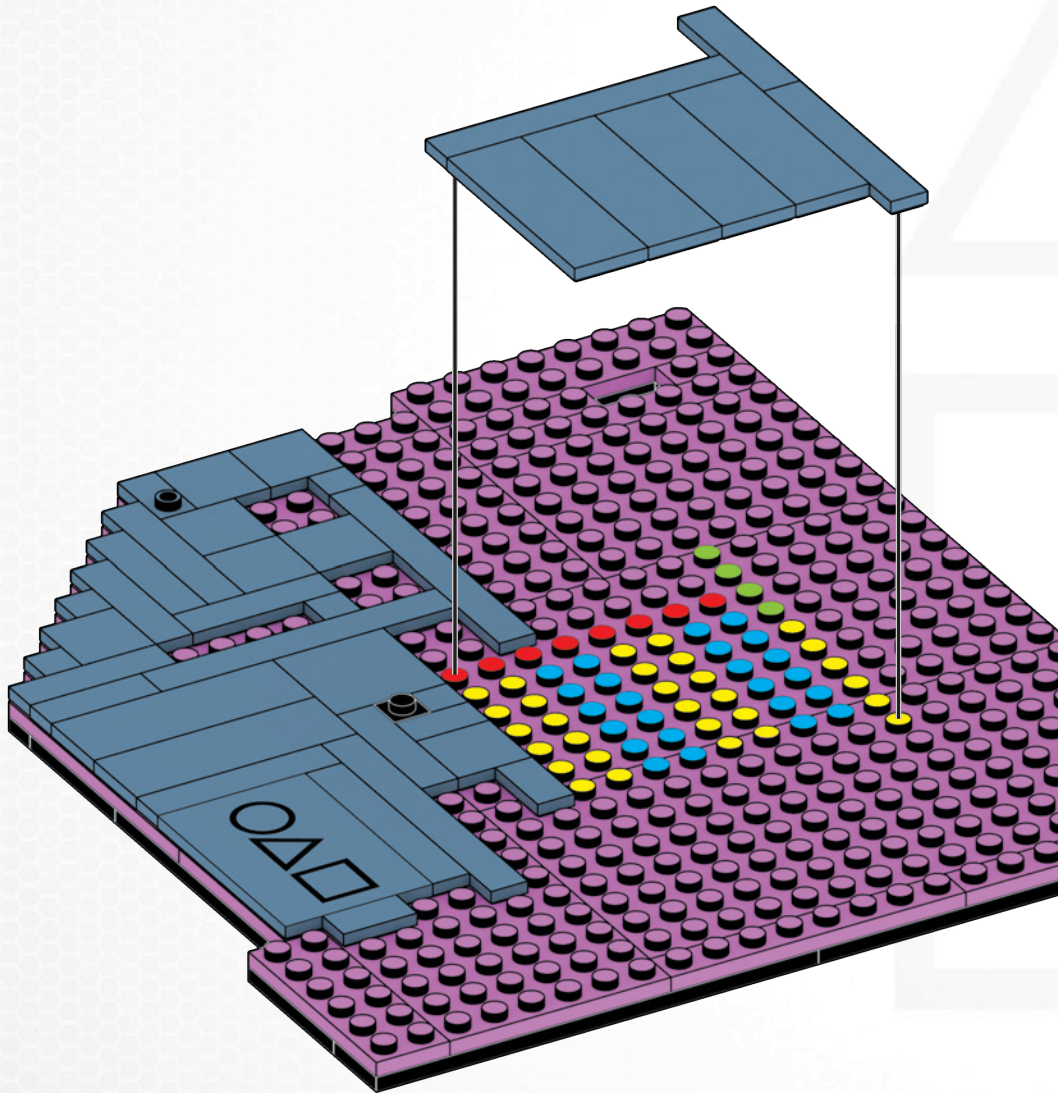
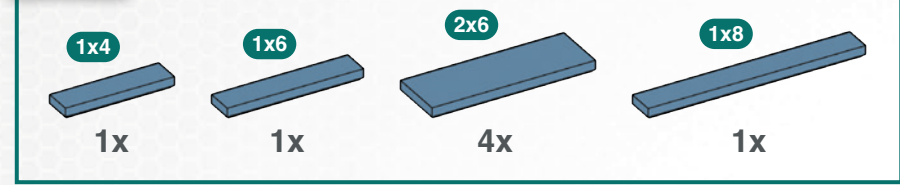

029

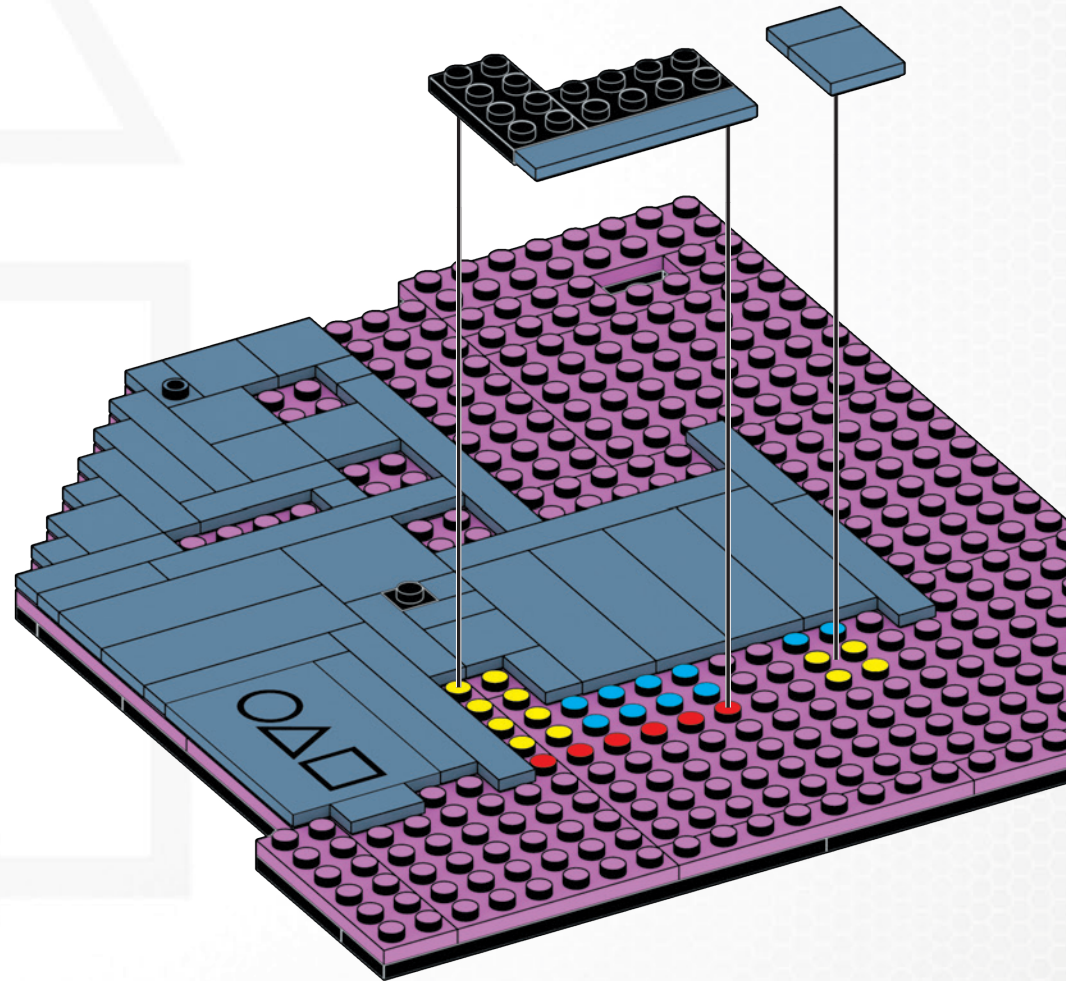
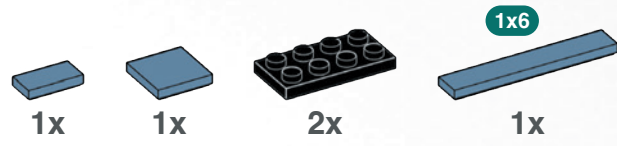

030

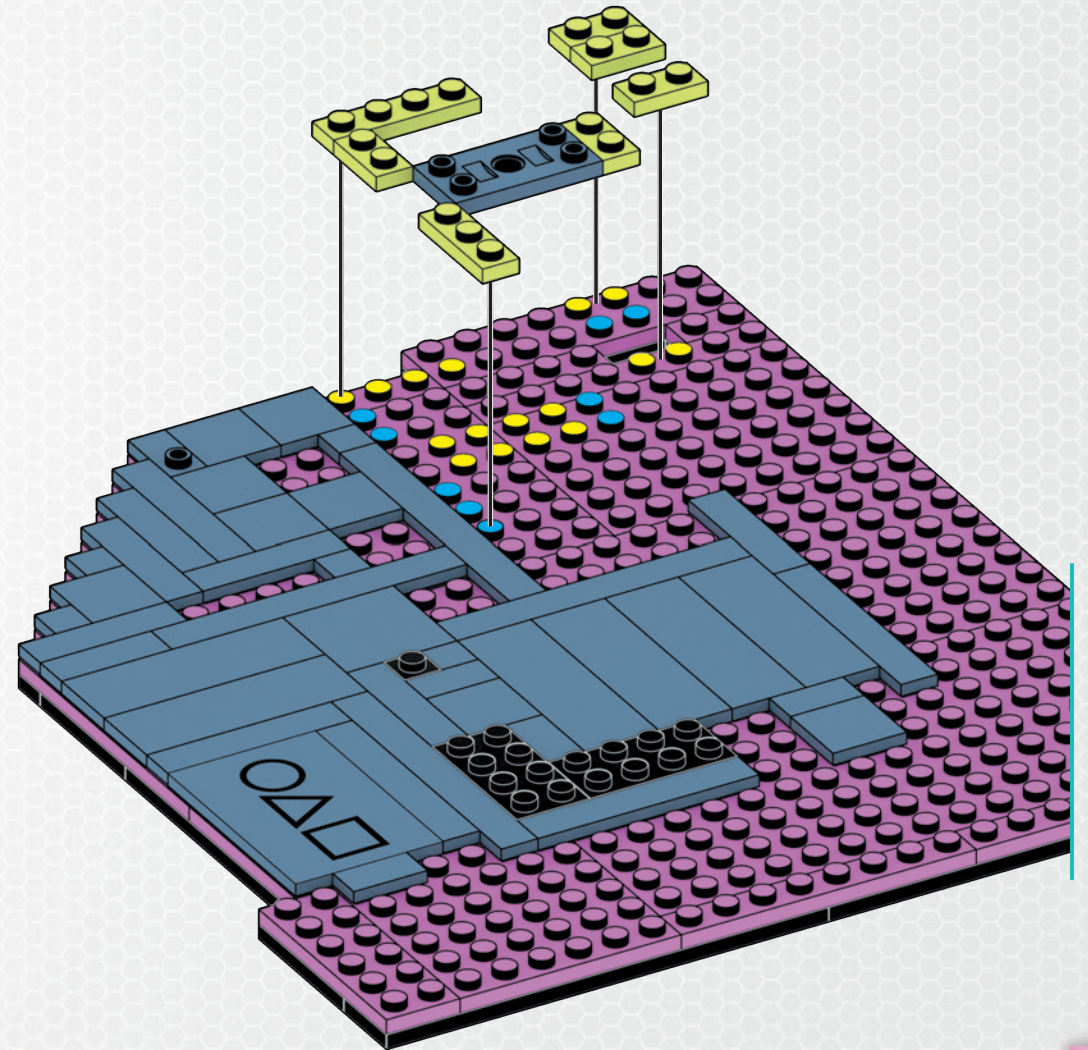

031

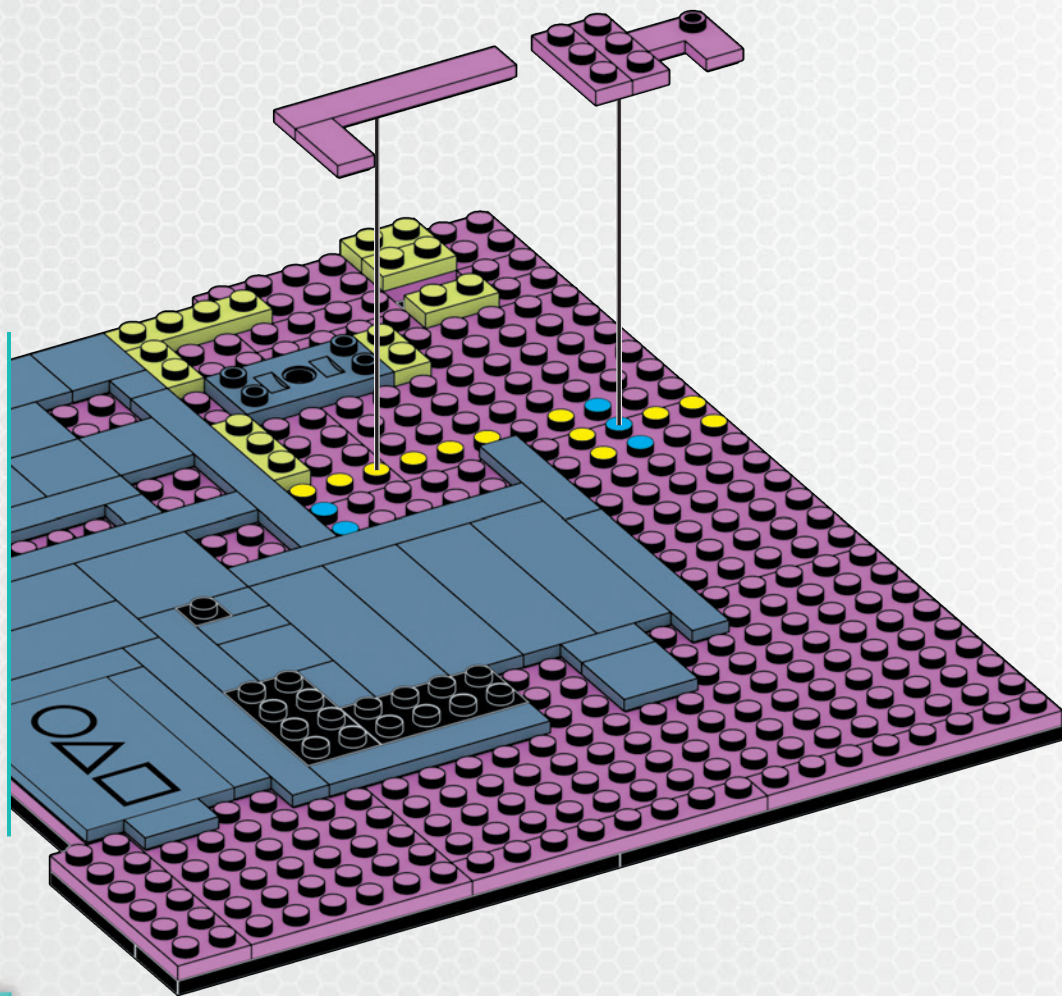
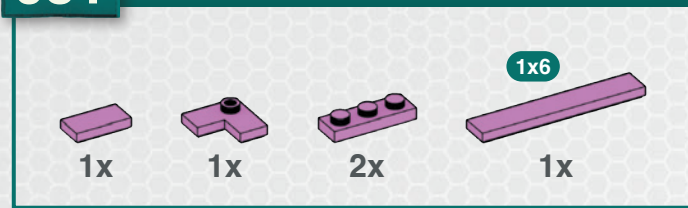

032

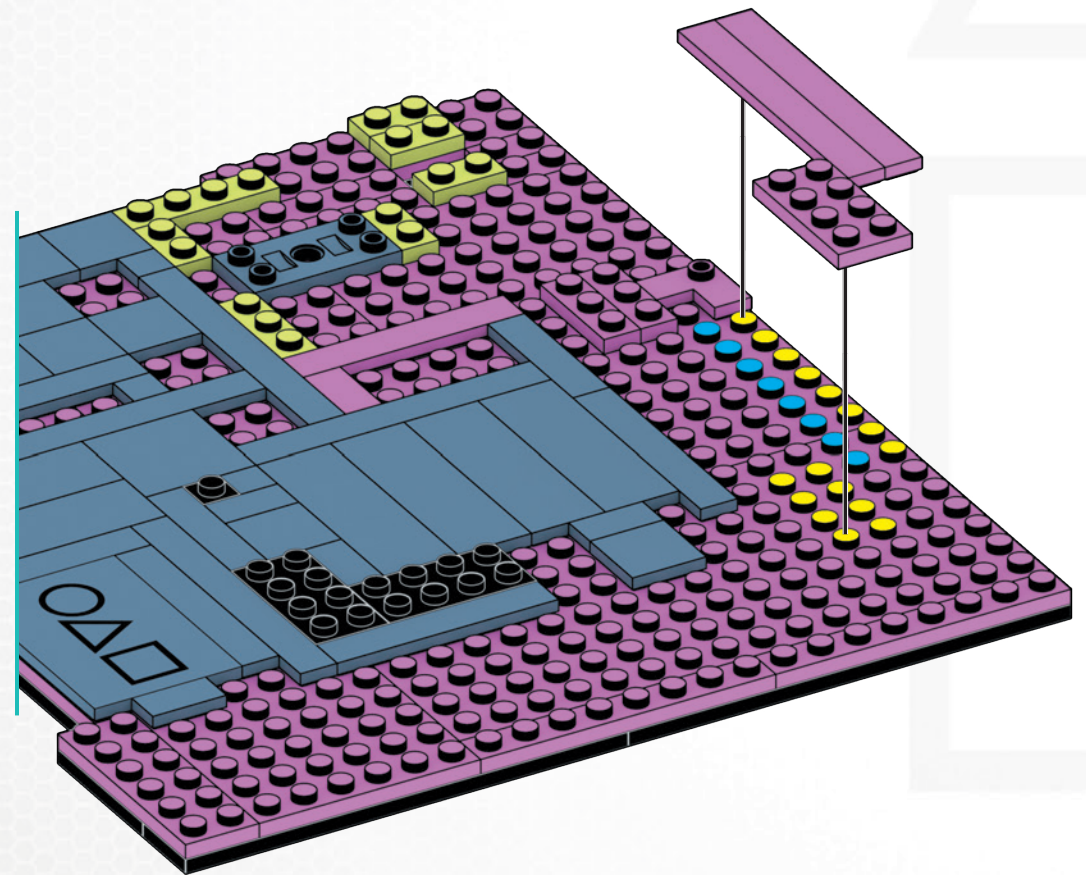
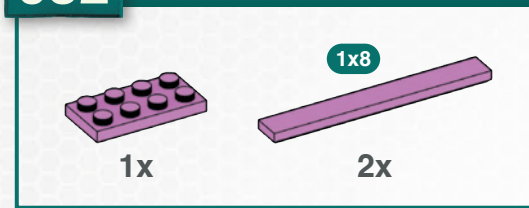



033



3x

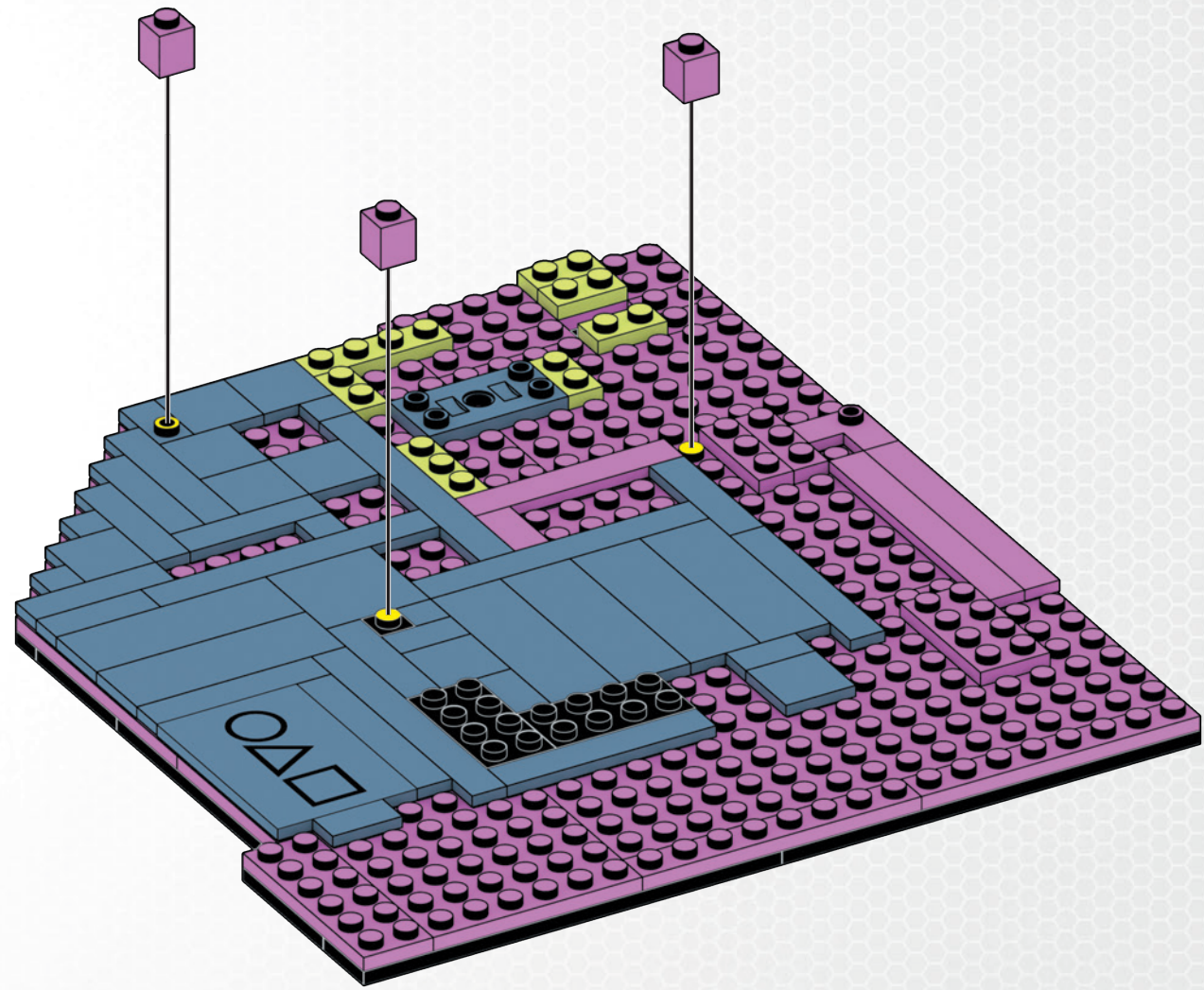

034



3x

1x

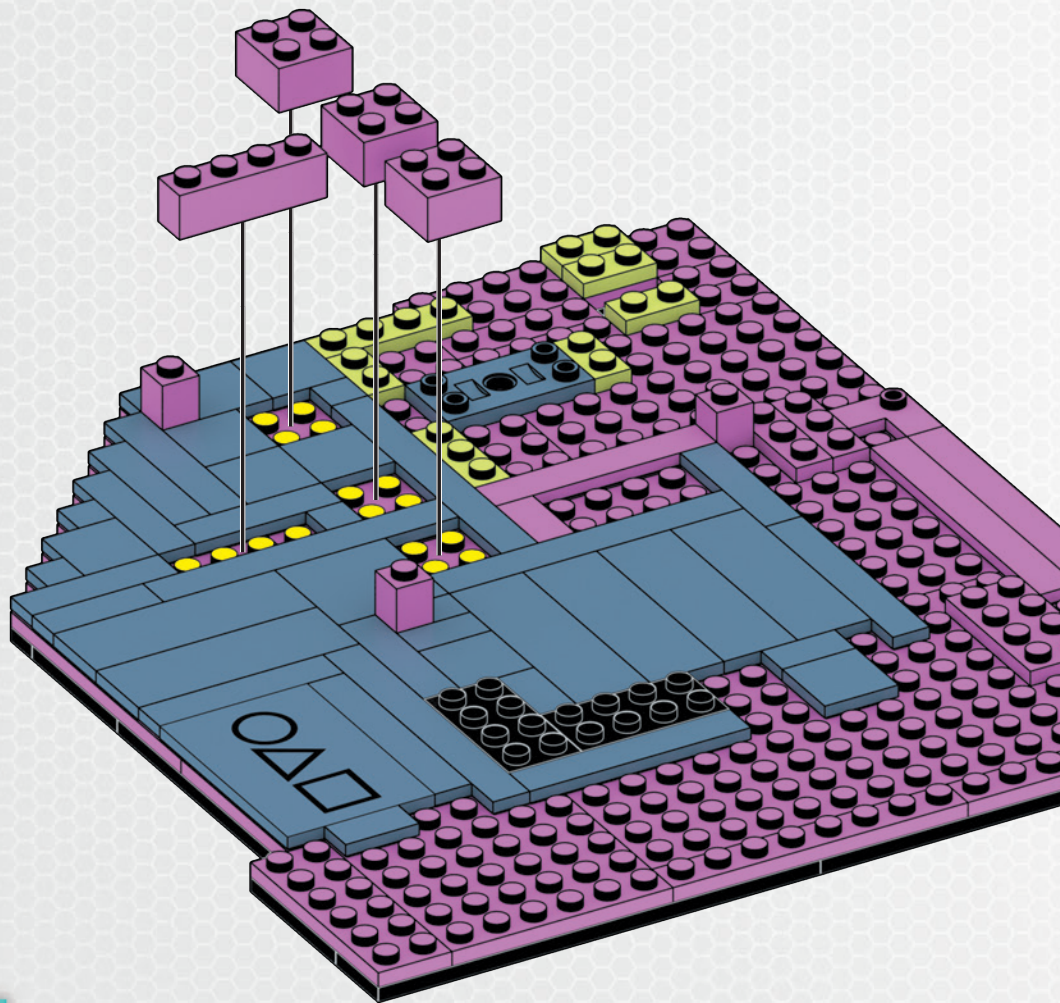

035



2x

1x

1x

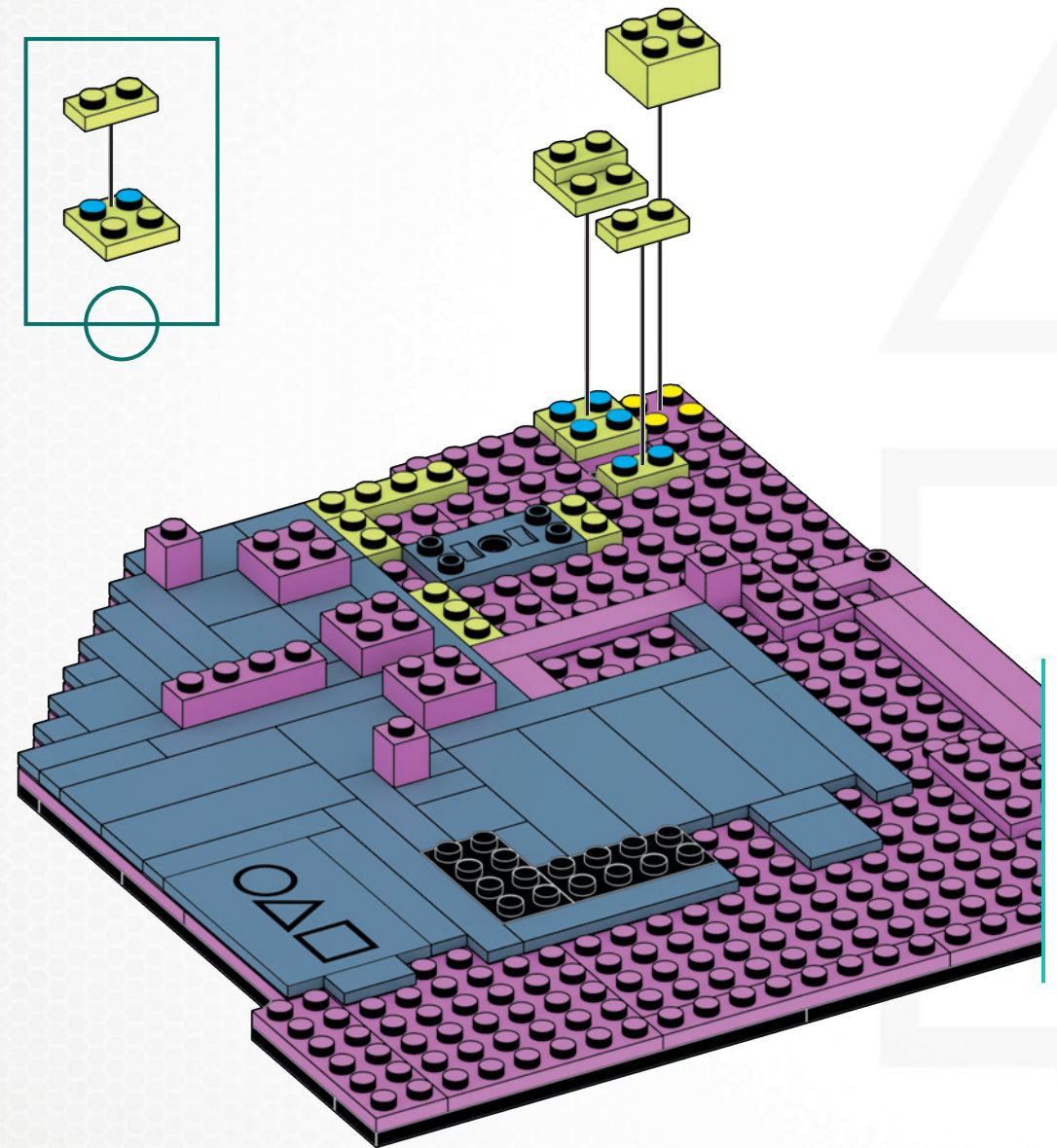
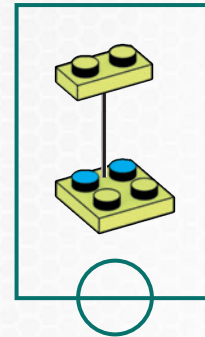

036

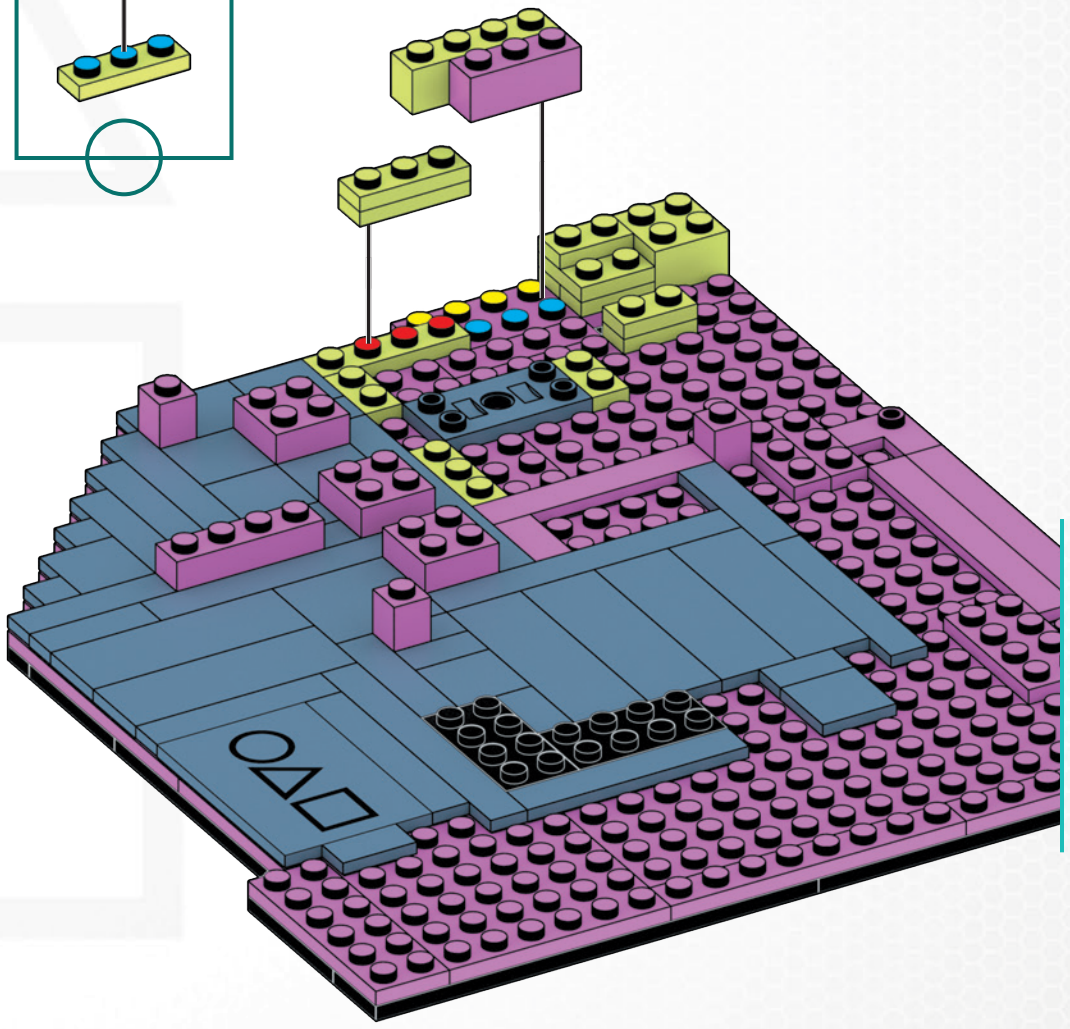
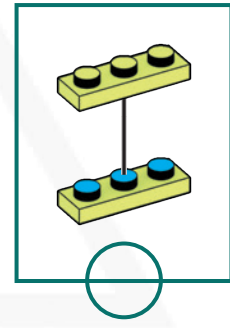
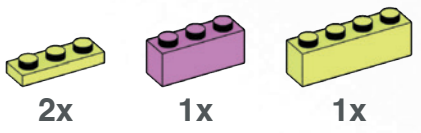

037

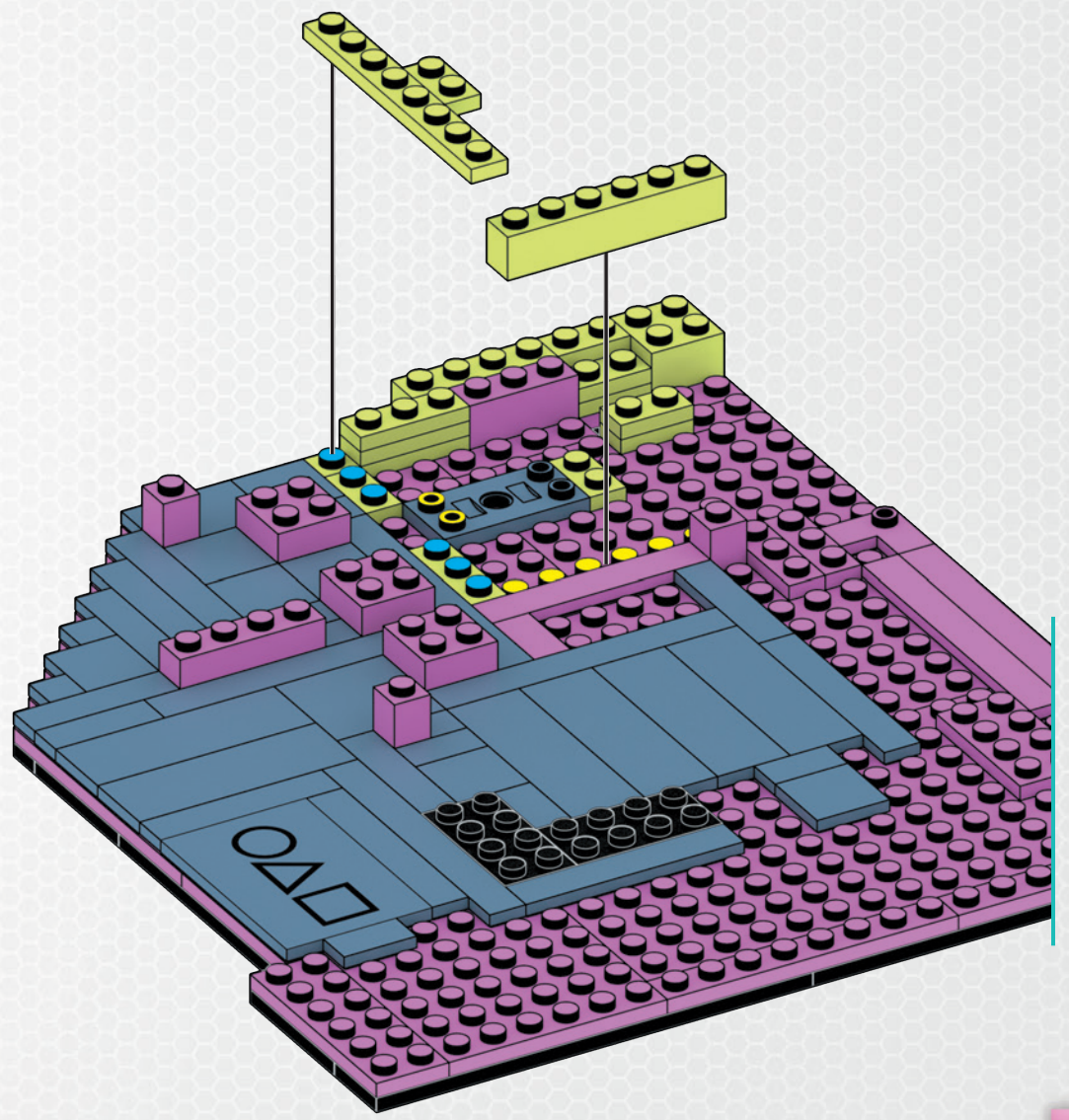
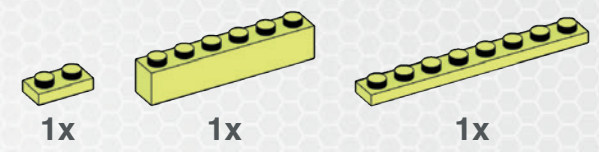

038

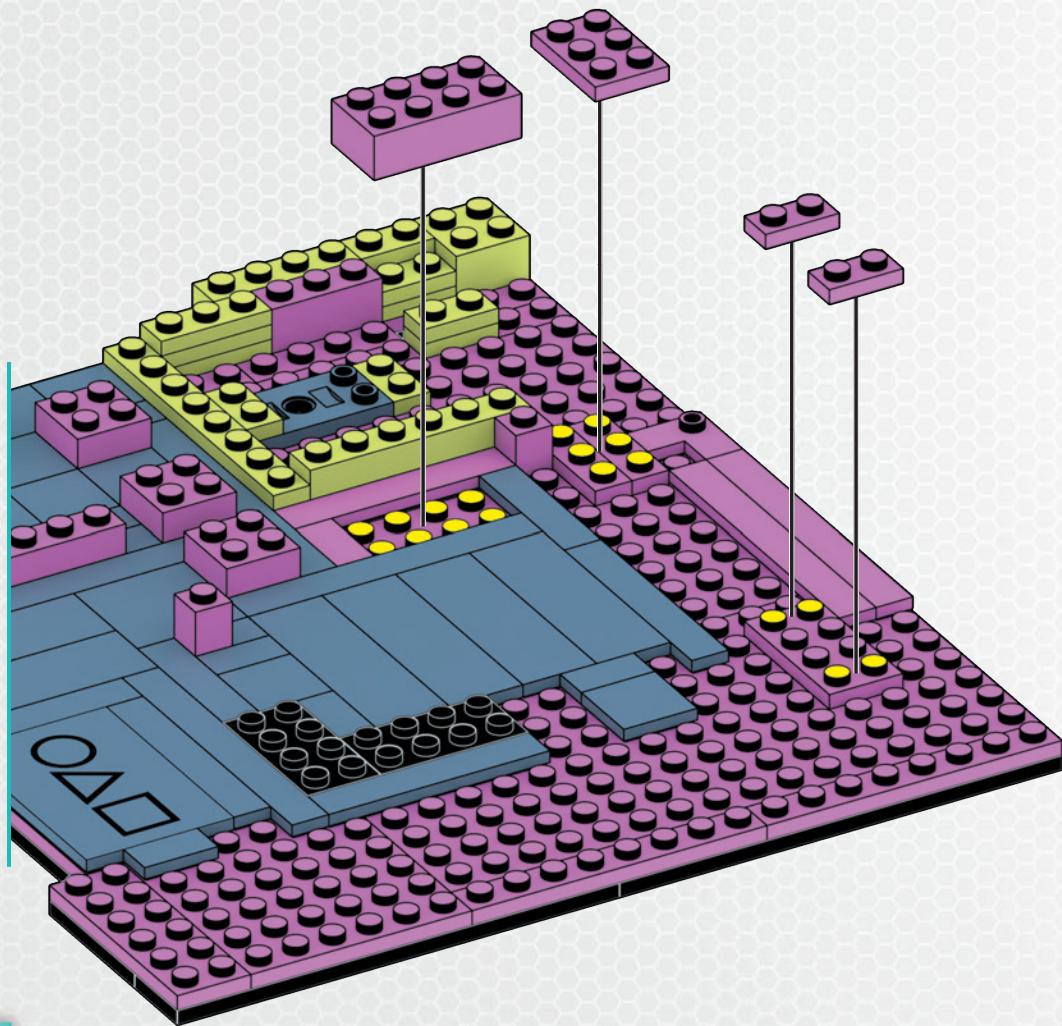
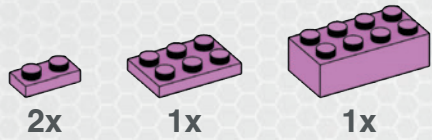

039

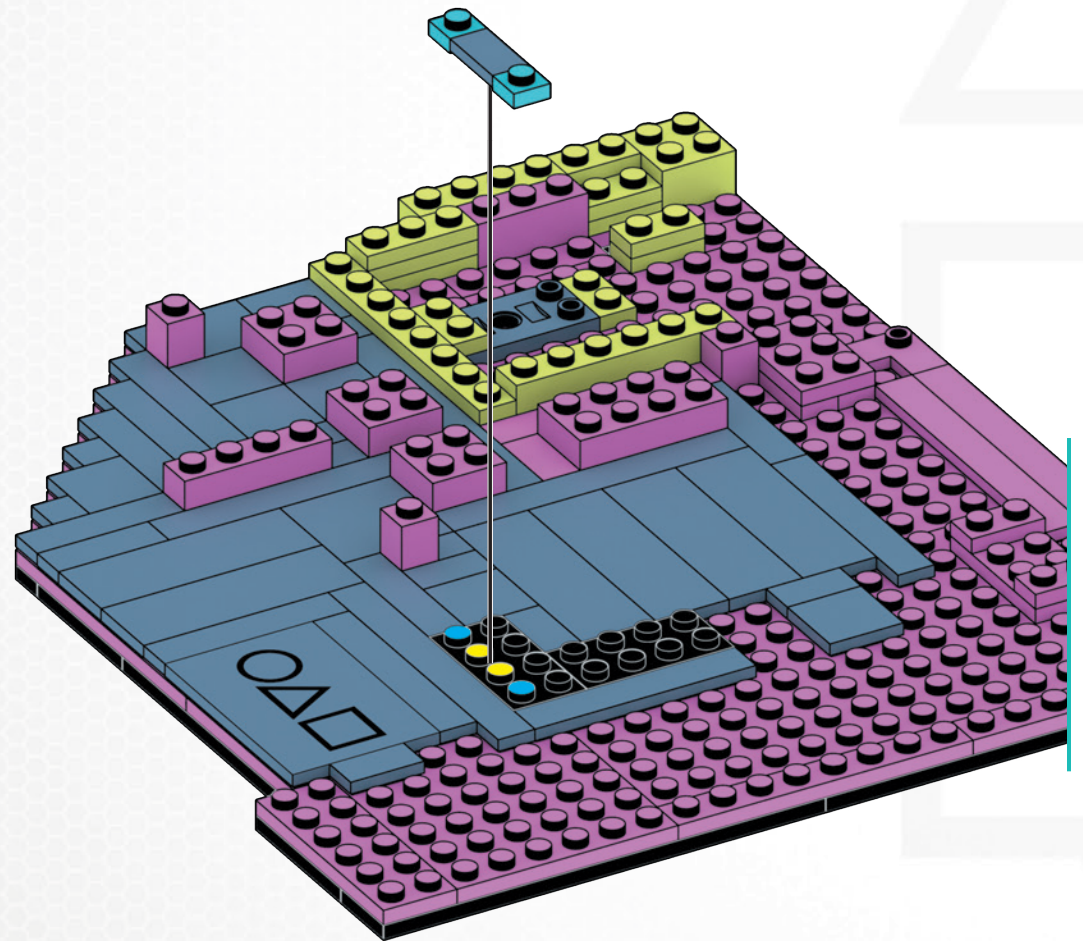

040

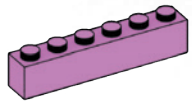

2x

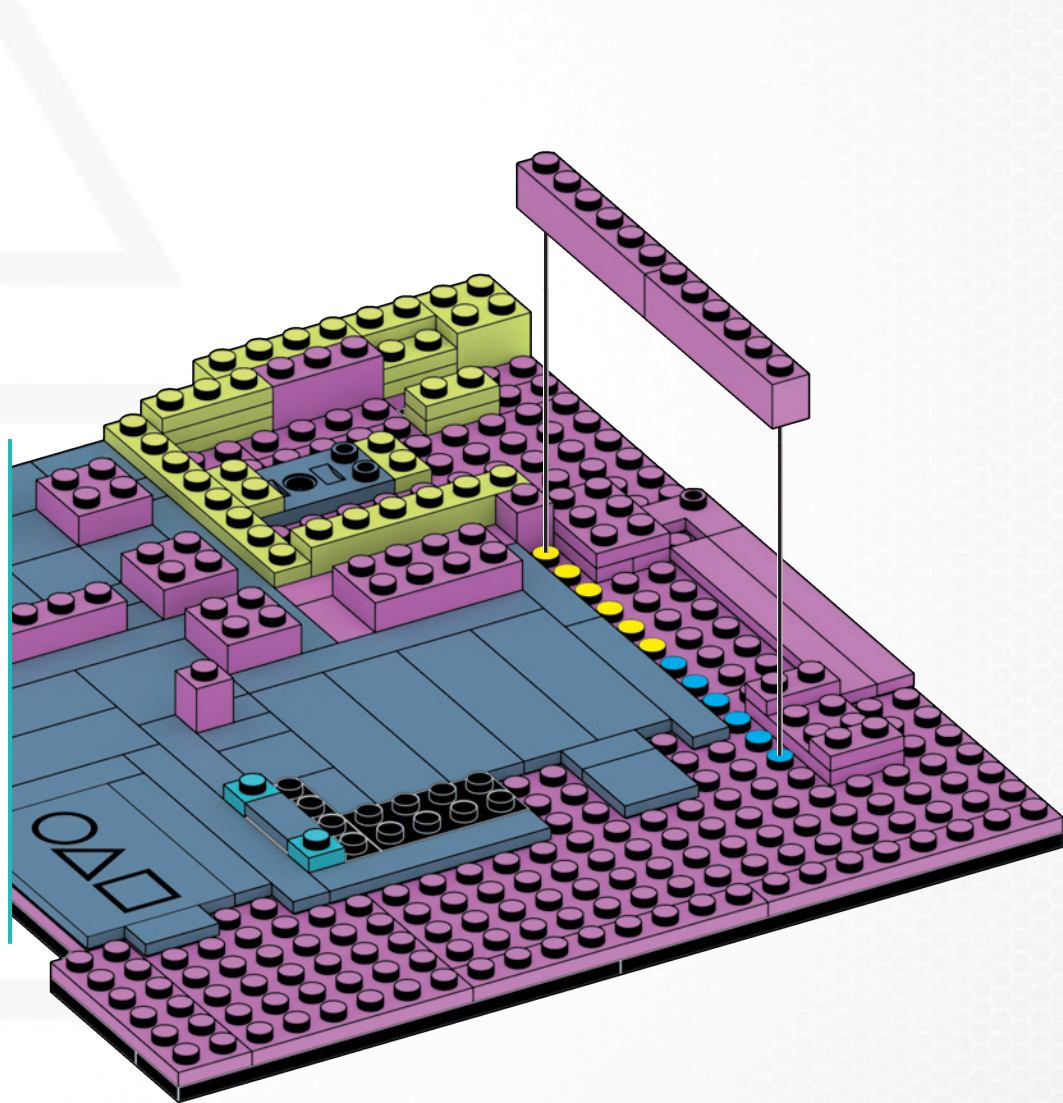

041

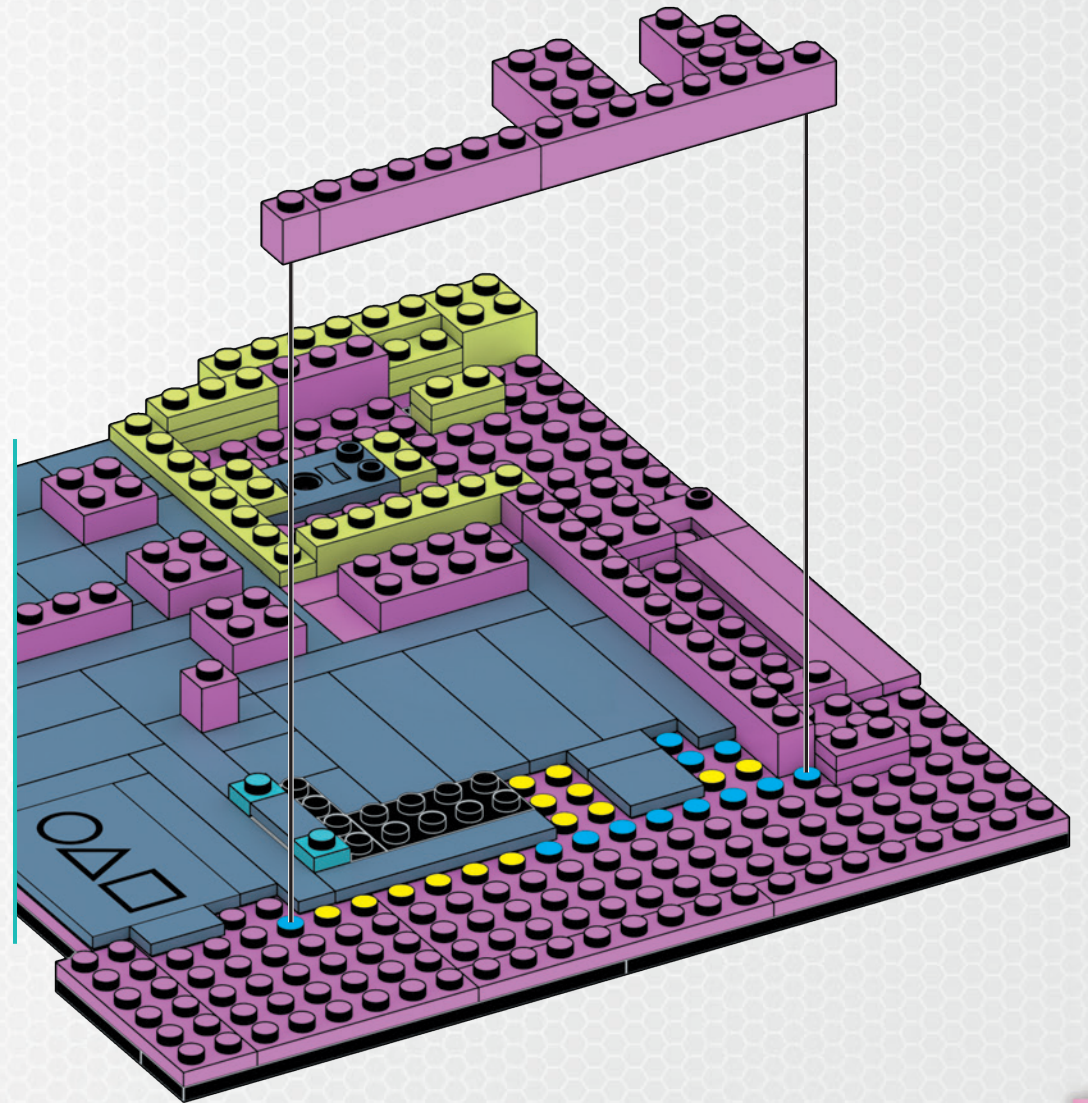
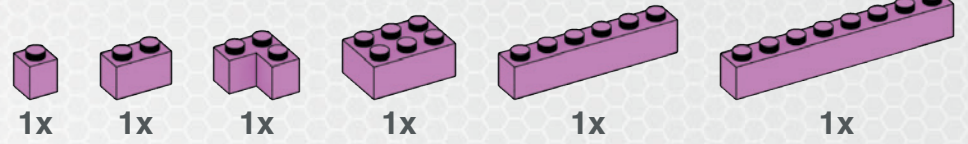

042

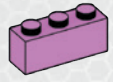

1x

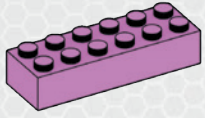

1x

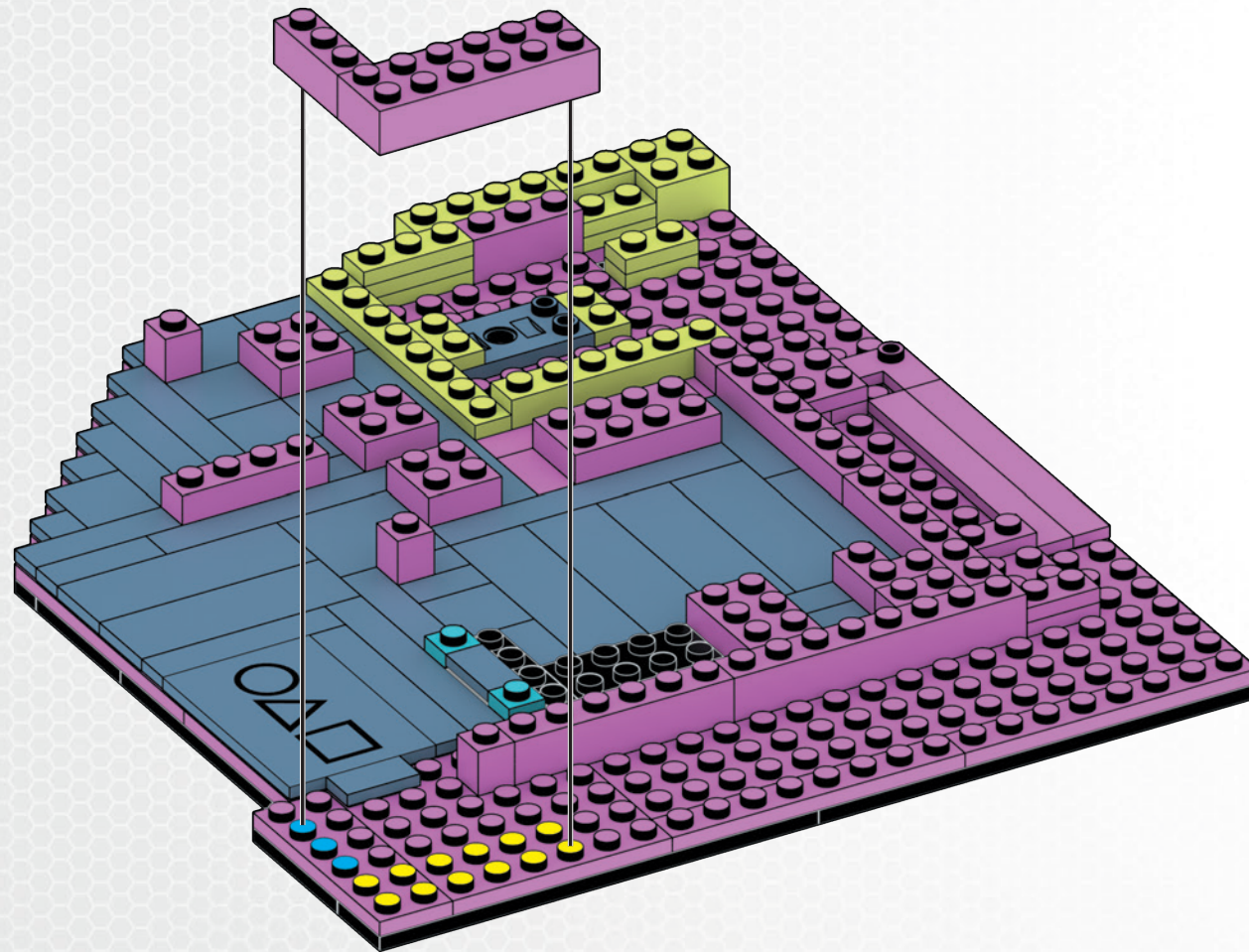

043

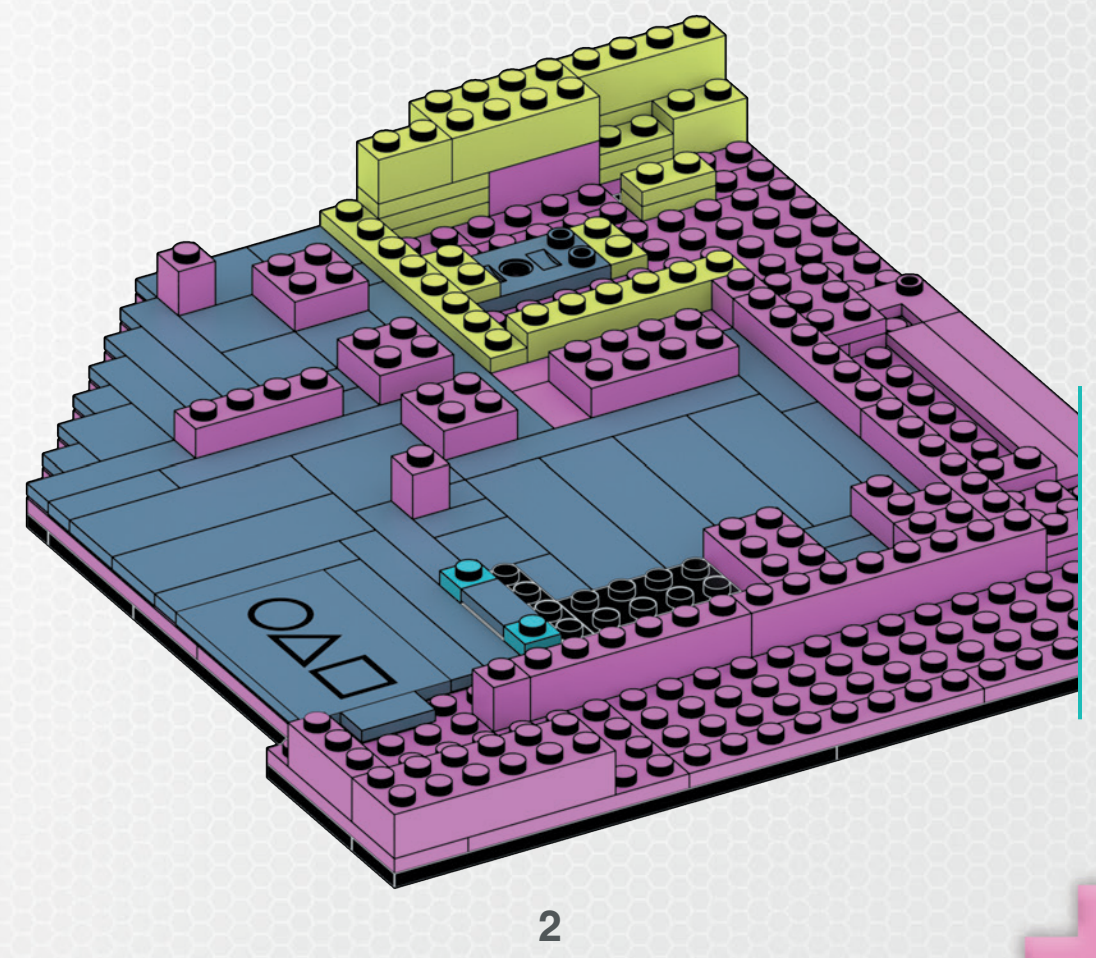
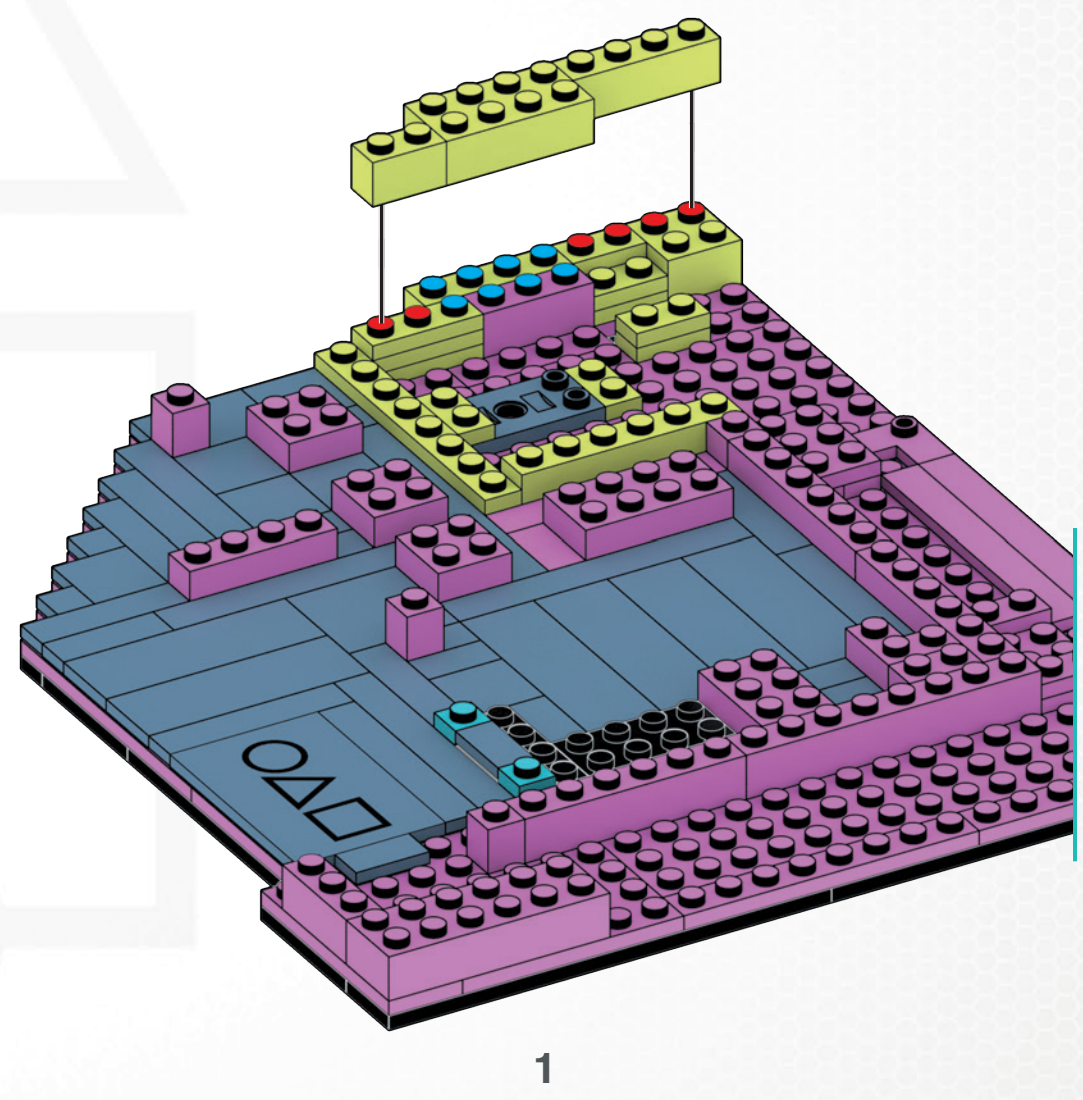
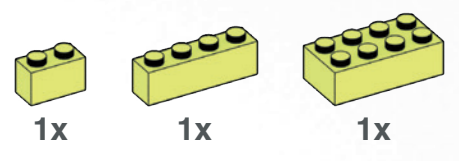

044

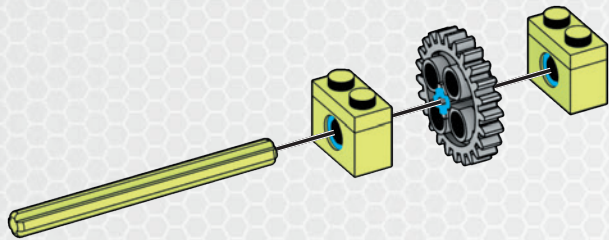

x2



045

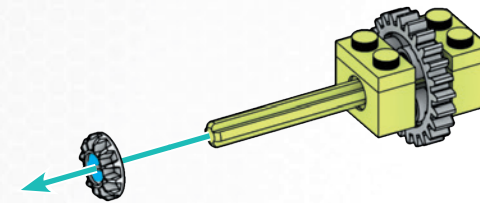

1

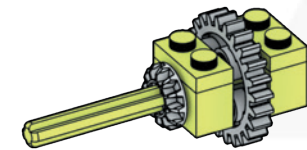

2

046



047

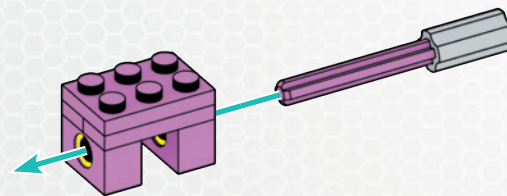
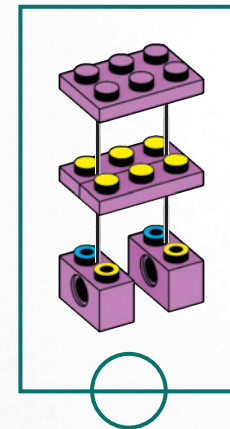
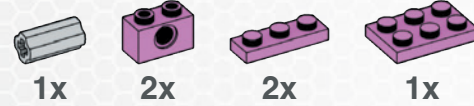

1

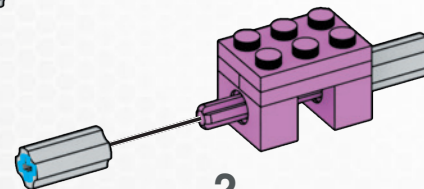

2

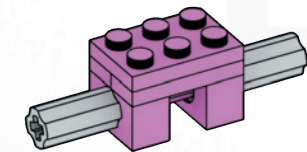

3

048

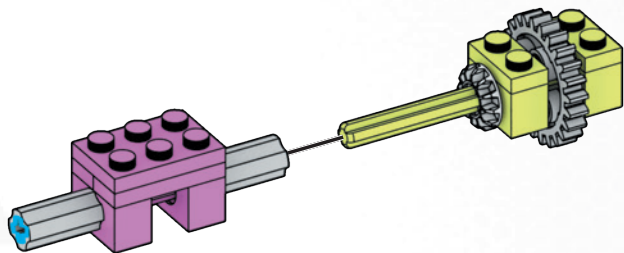

049

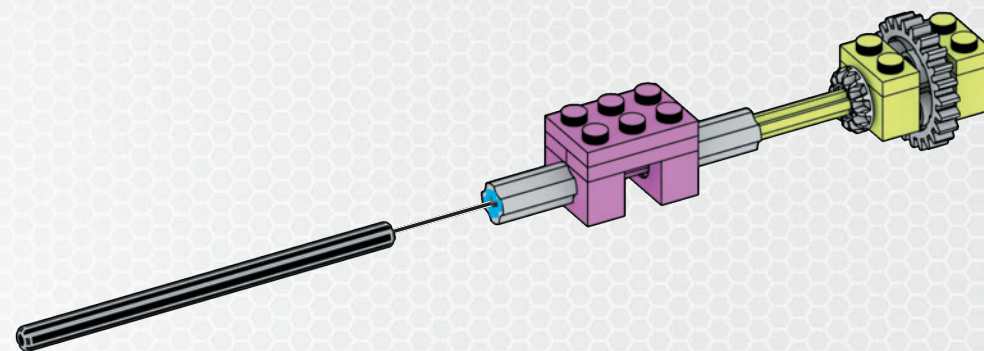

050

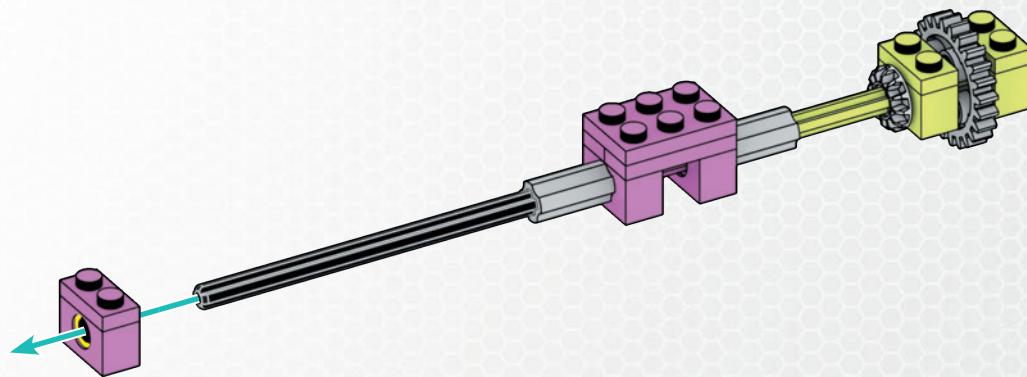
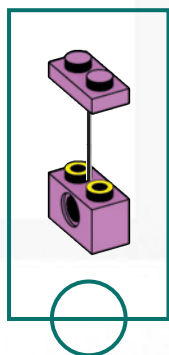
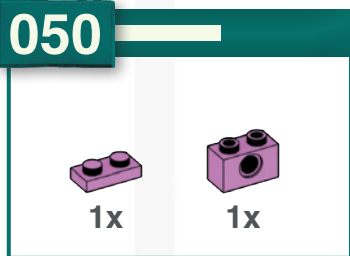

051



1x



1x



1x

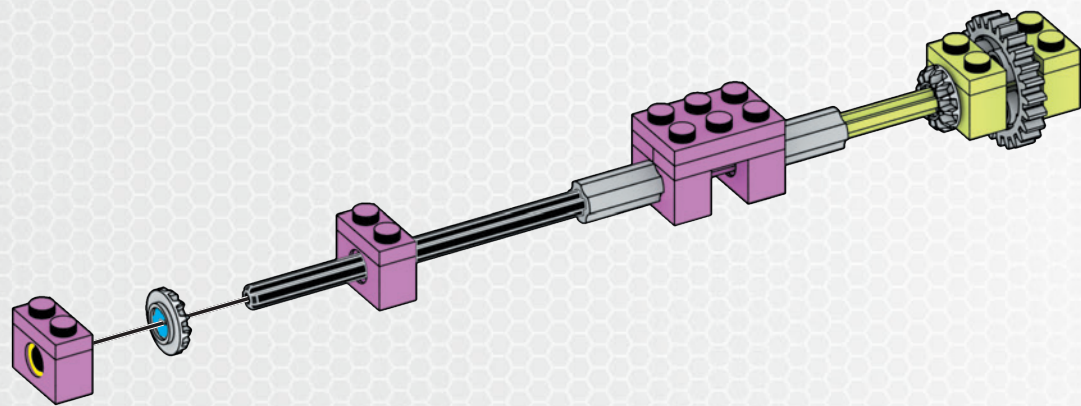
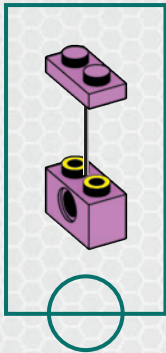

1

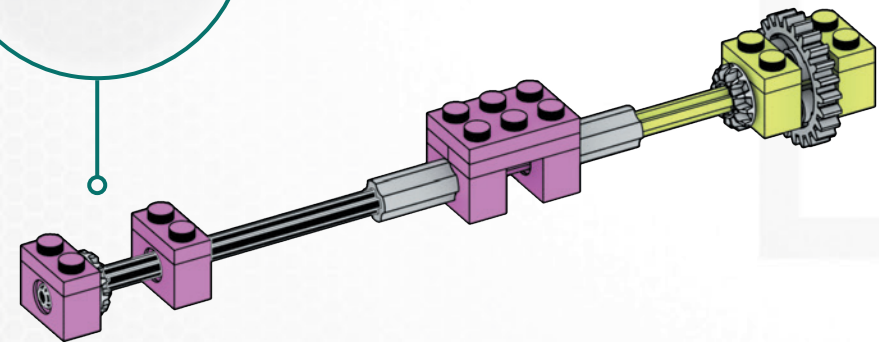
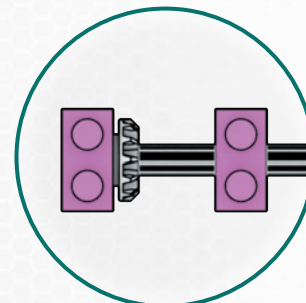

2

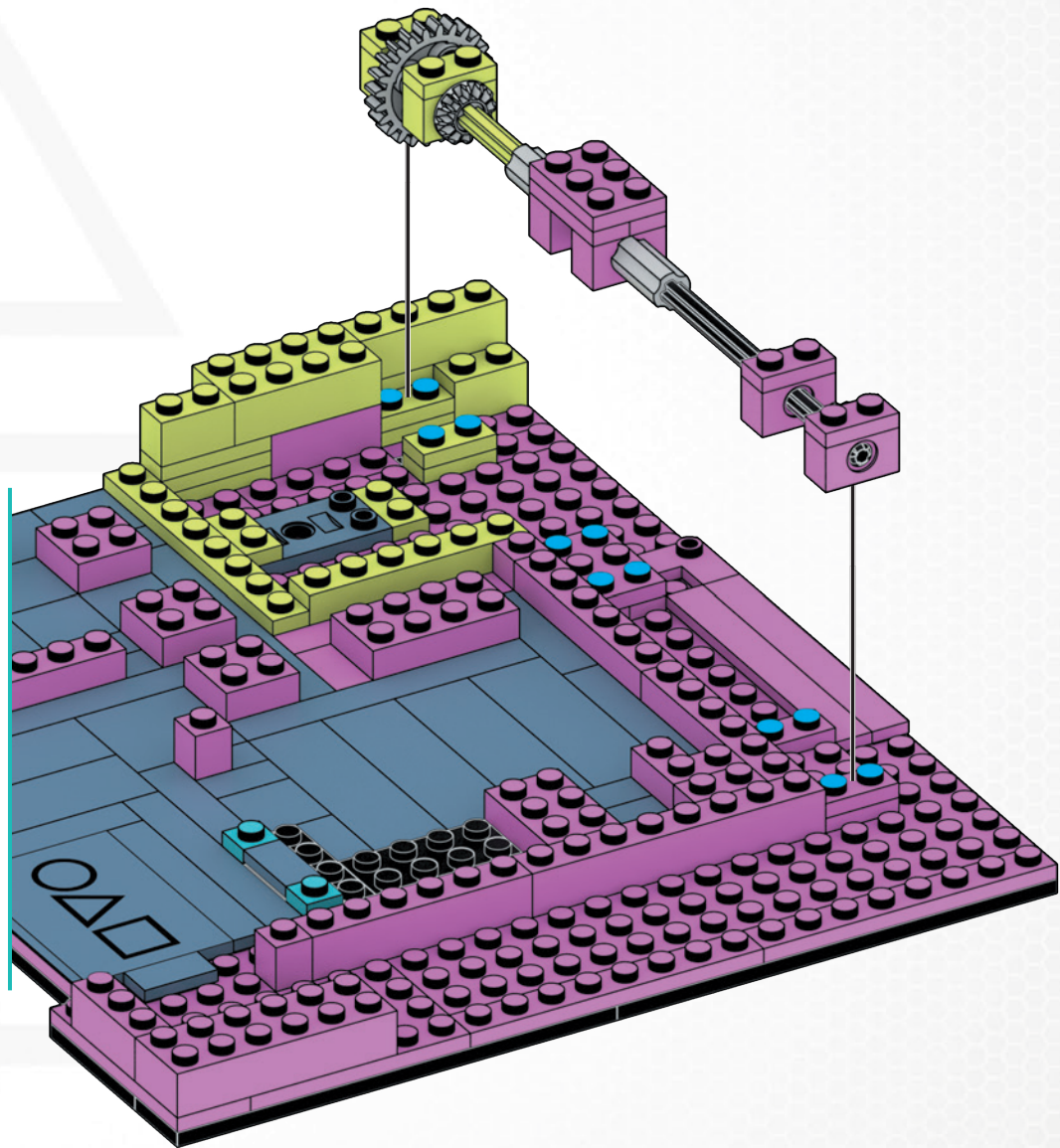

1

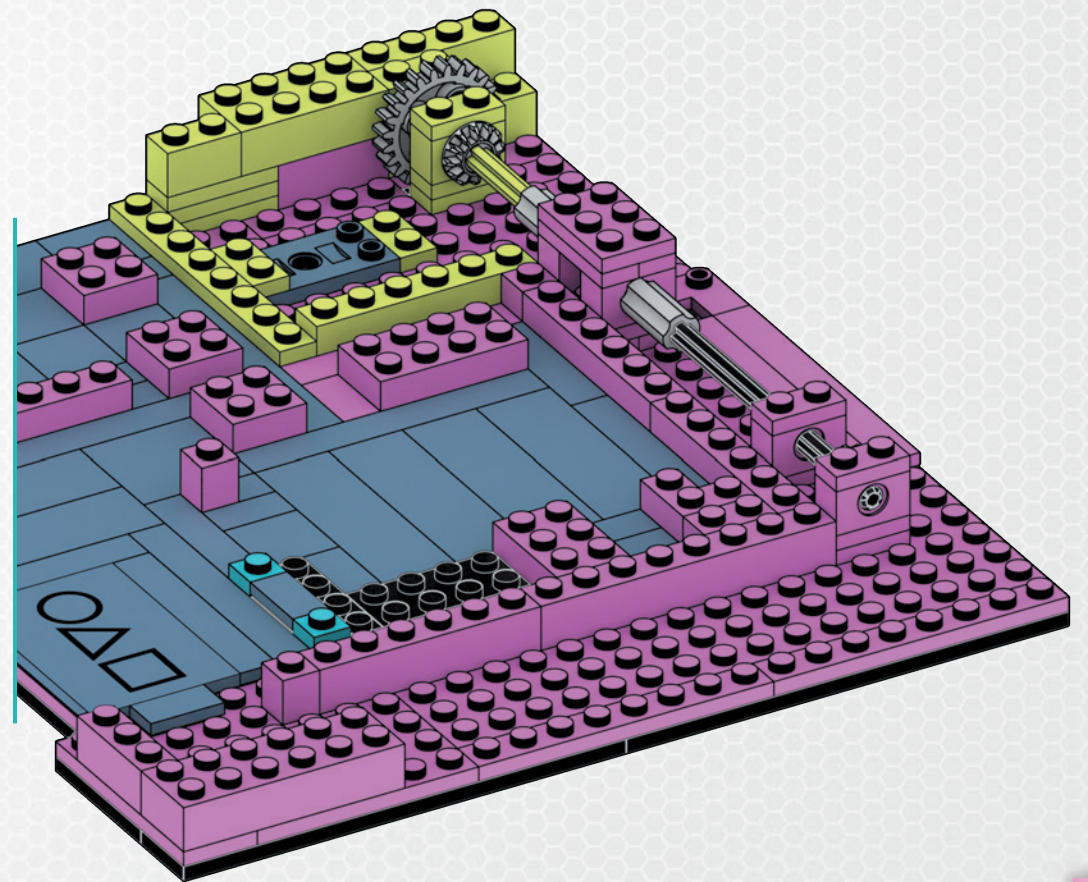

2

053

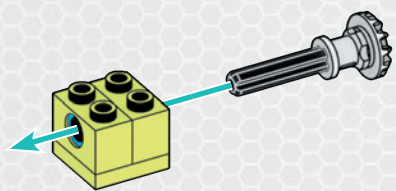
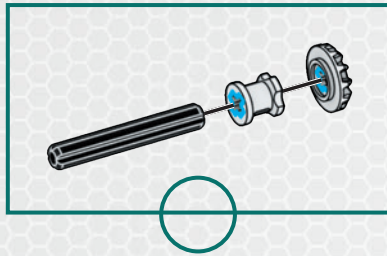
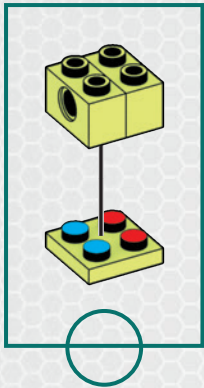

1

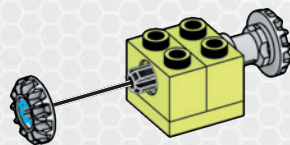

2

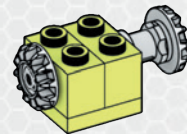

3

054

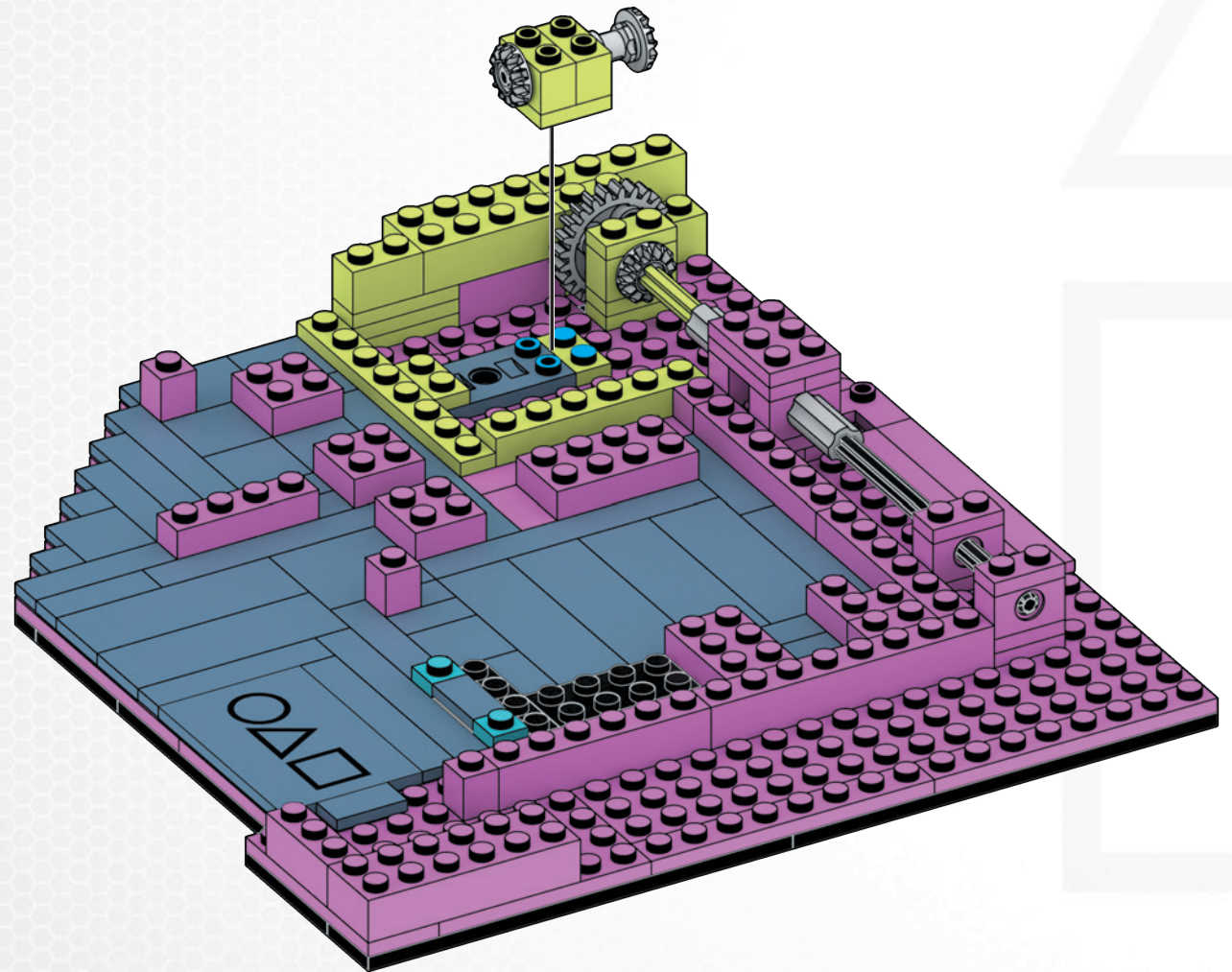

055



1x

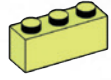

2x

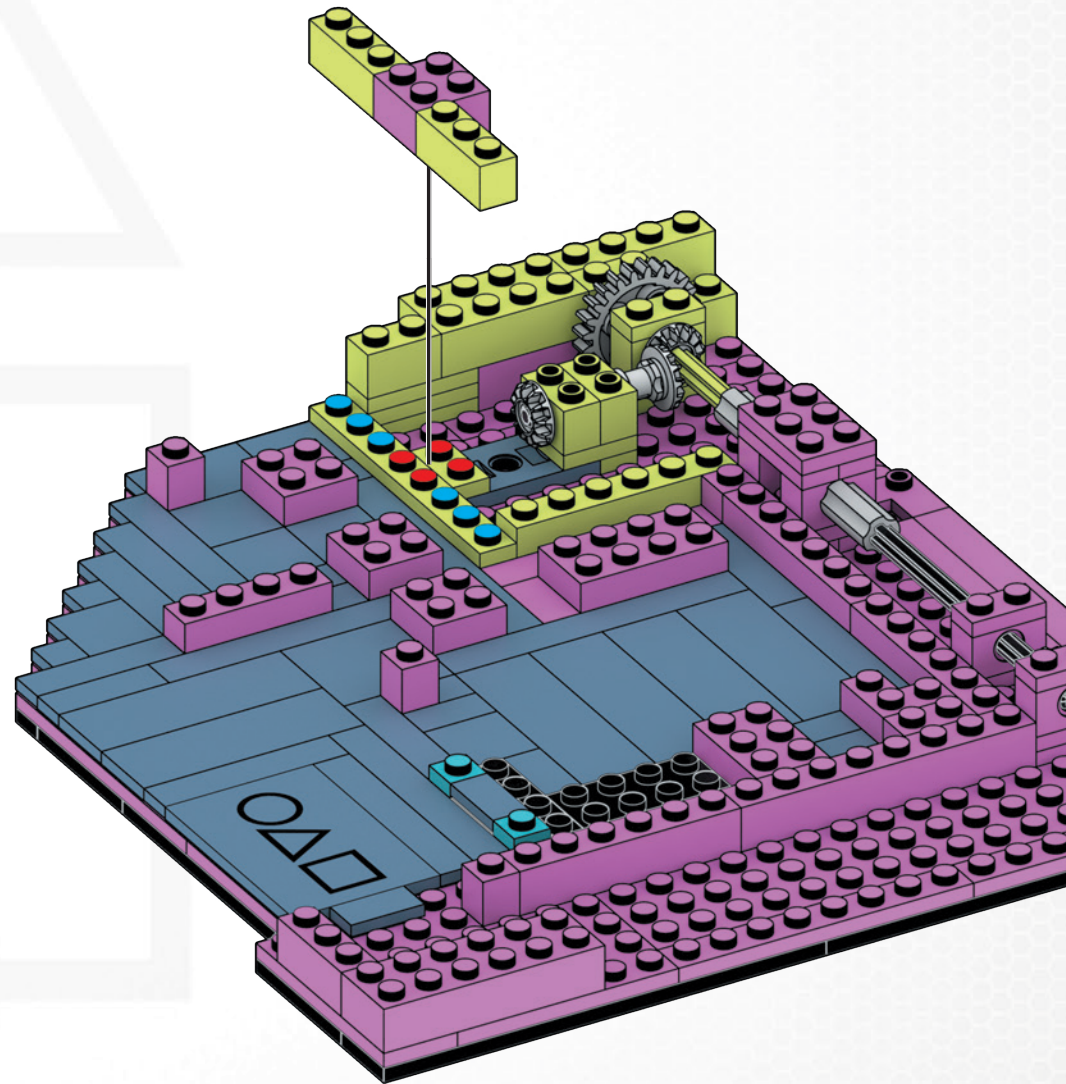

056



2x



1x



1x



2x

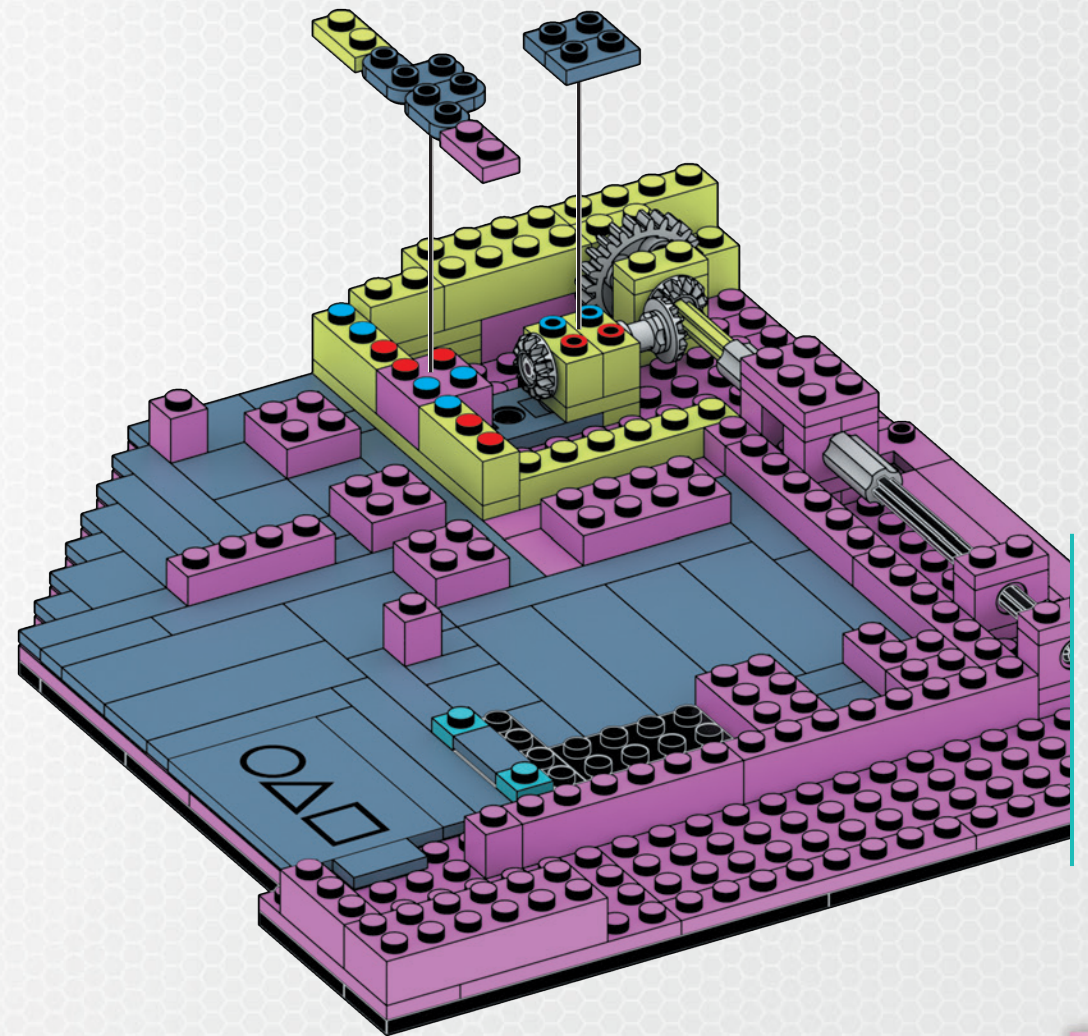

057

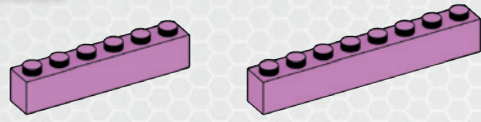

2x

1x

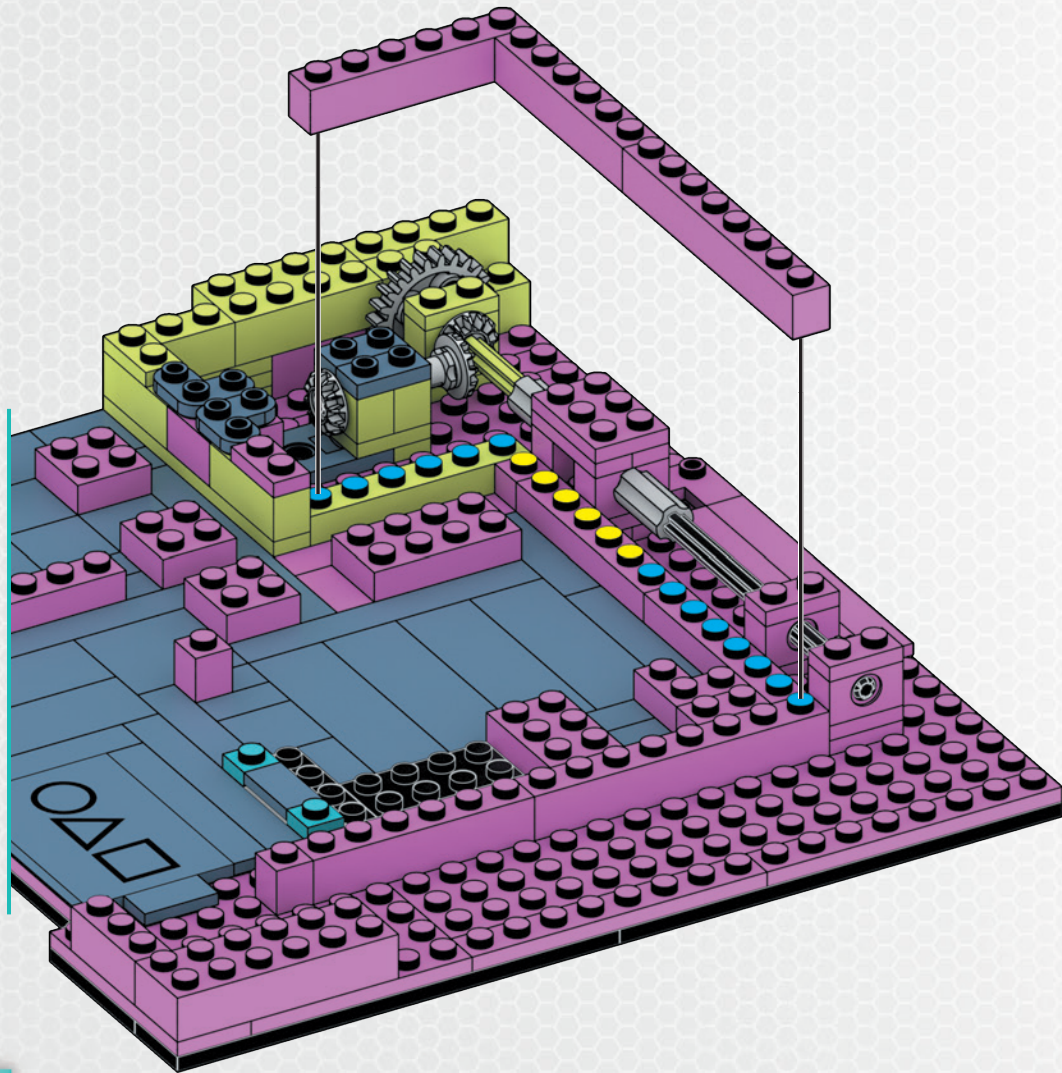

058

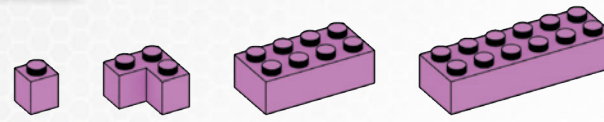

1x

1x

2x

1x

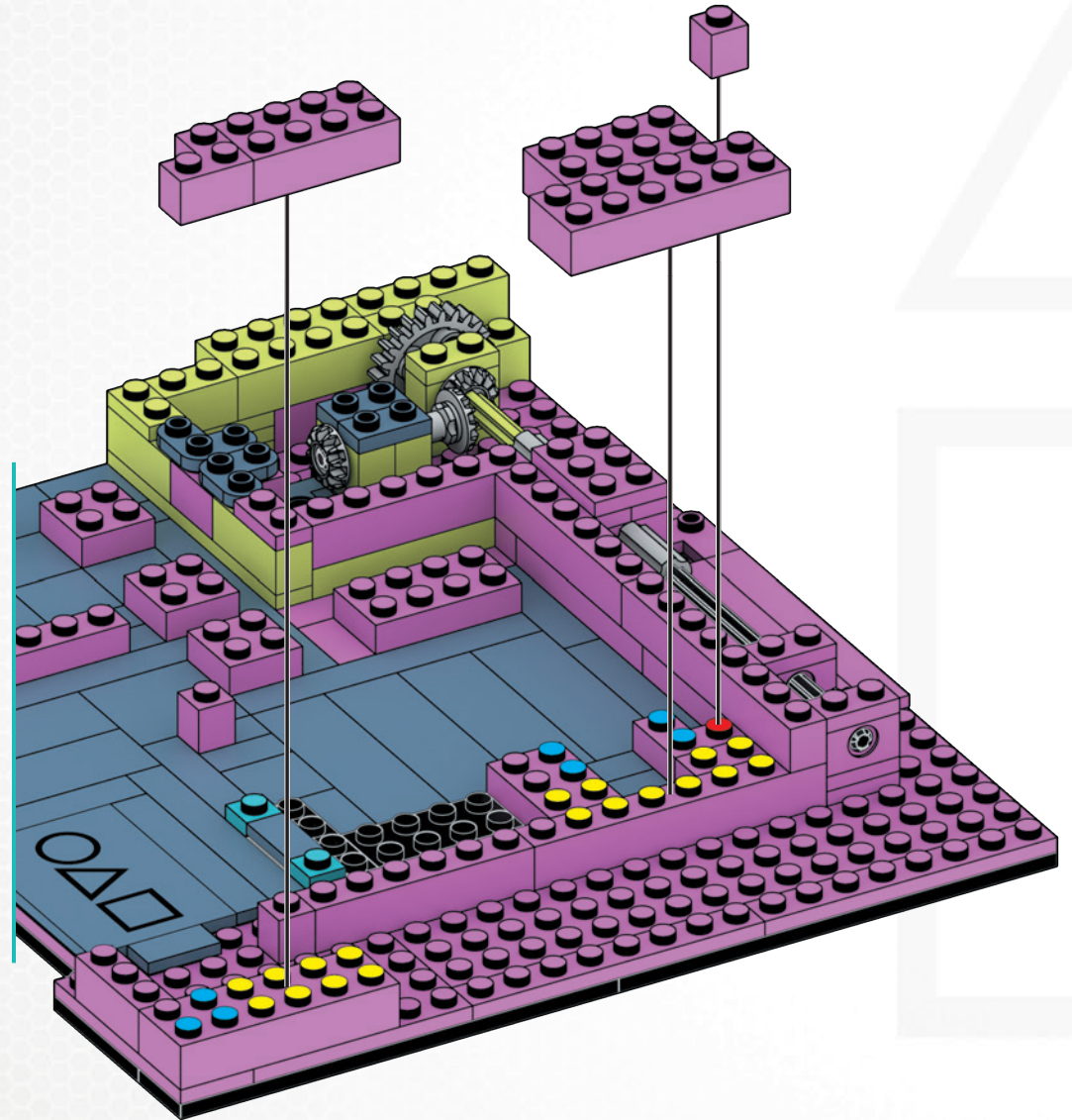

059

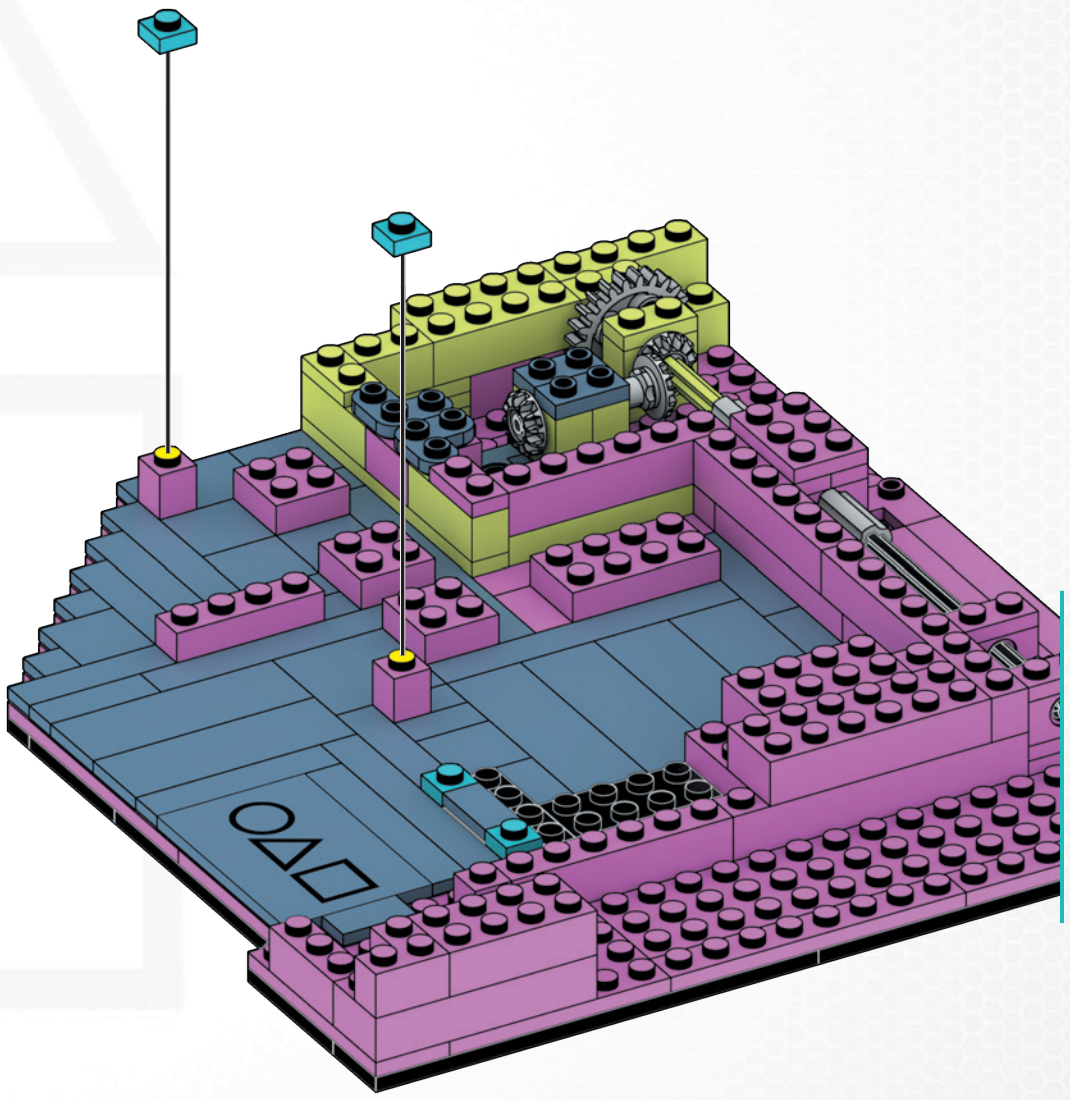

060

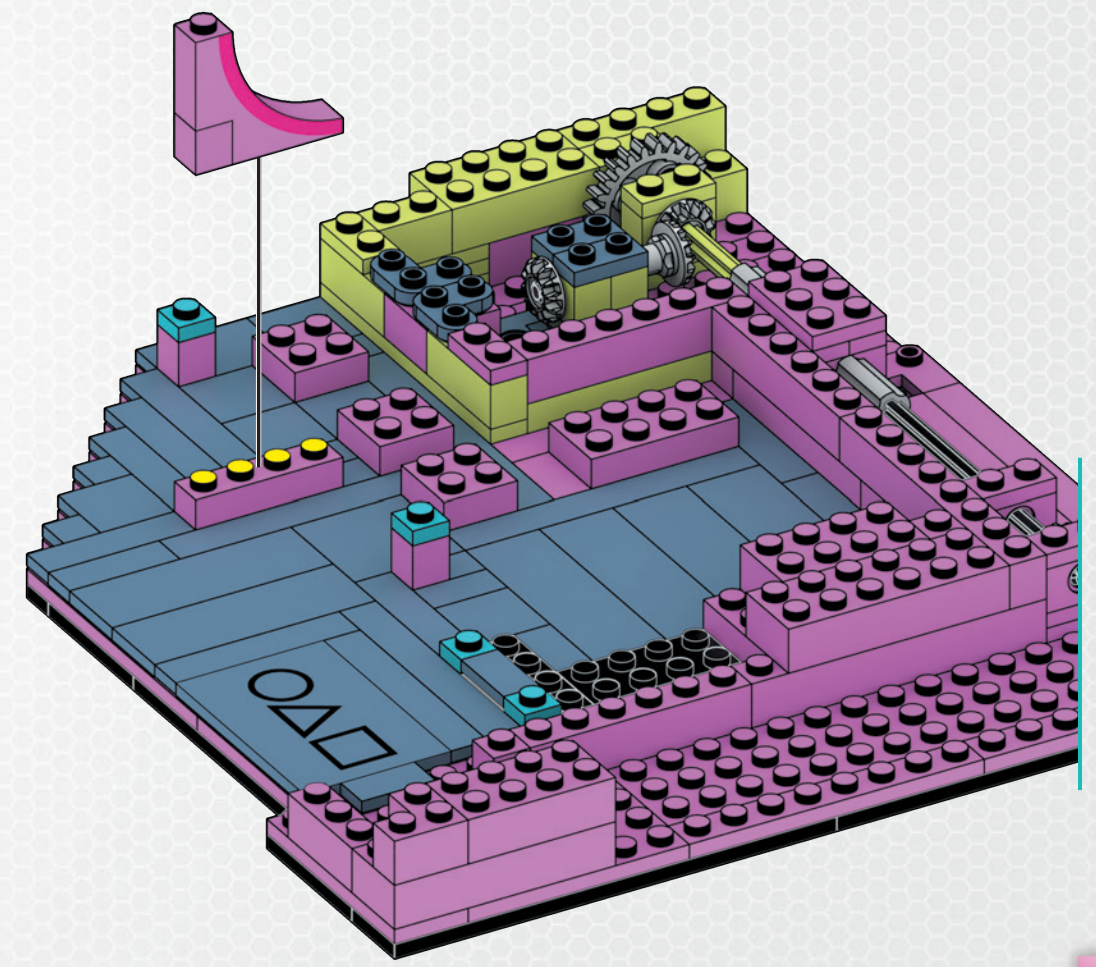
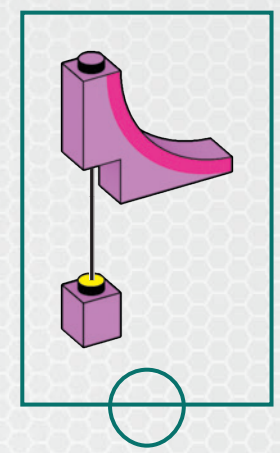

061



1x



1x

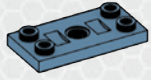

1x

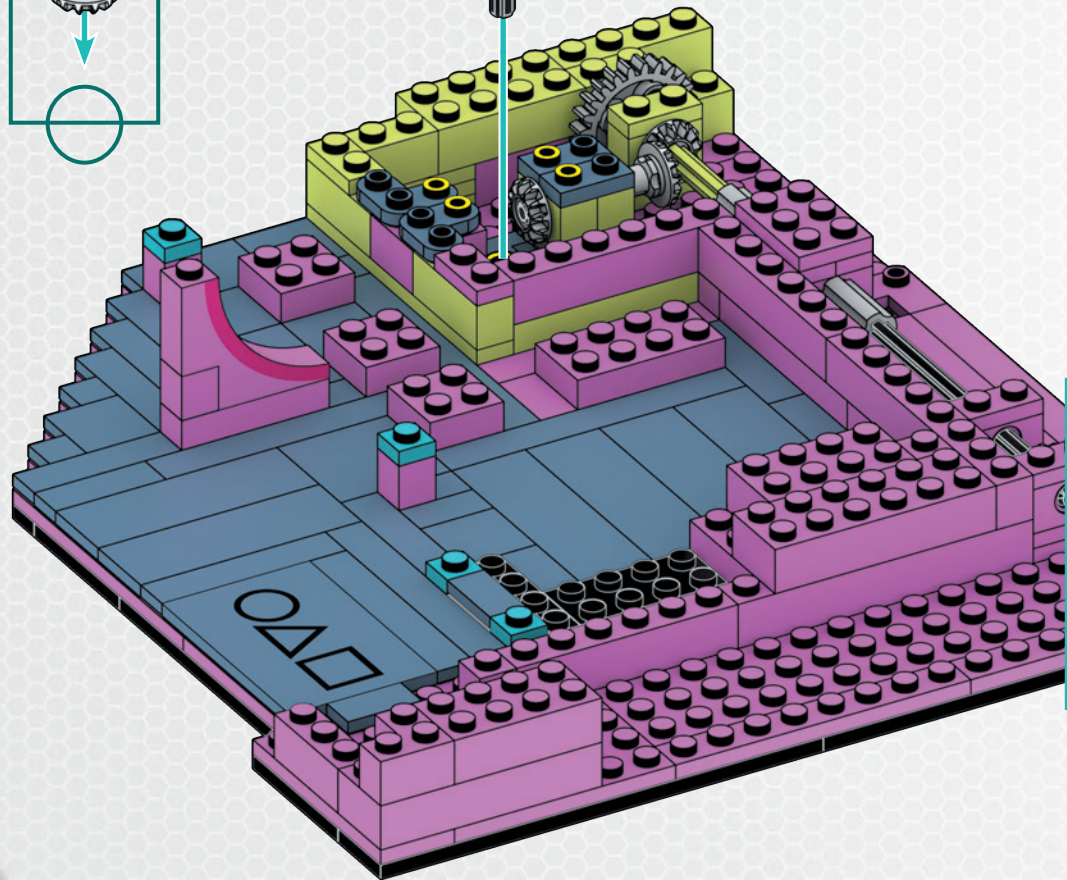
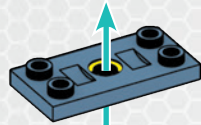
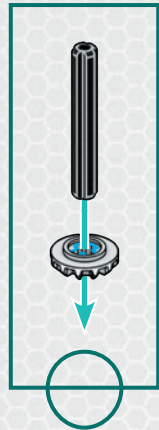

062



2x

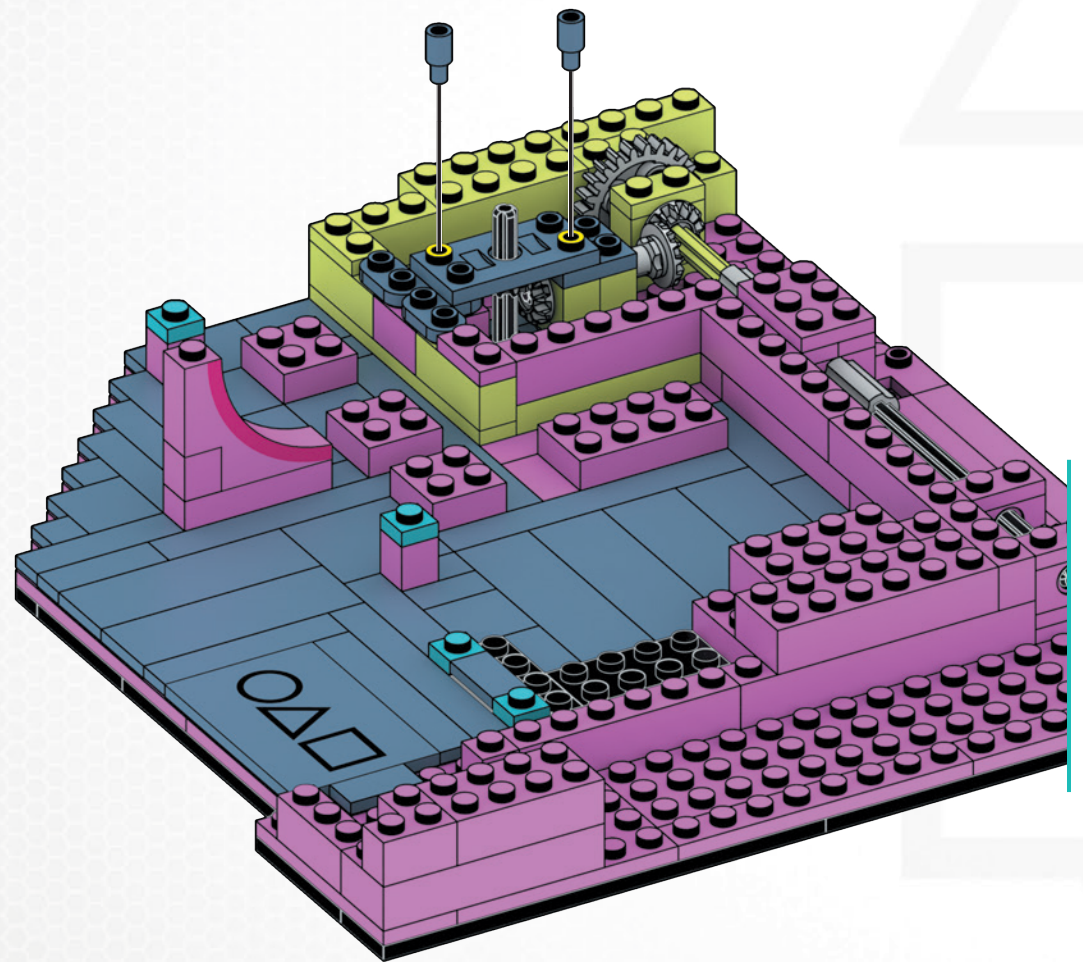

063

- 2x
- 1x
- 3x

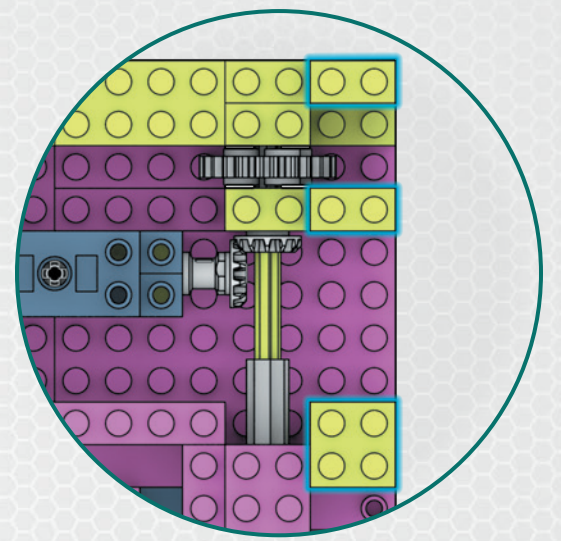
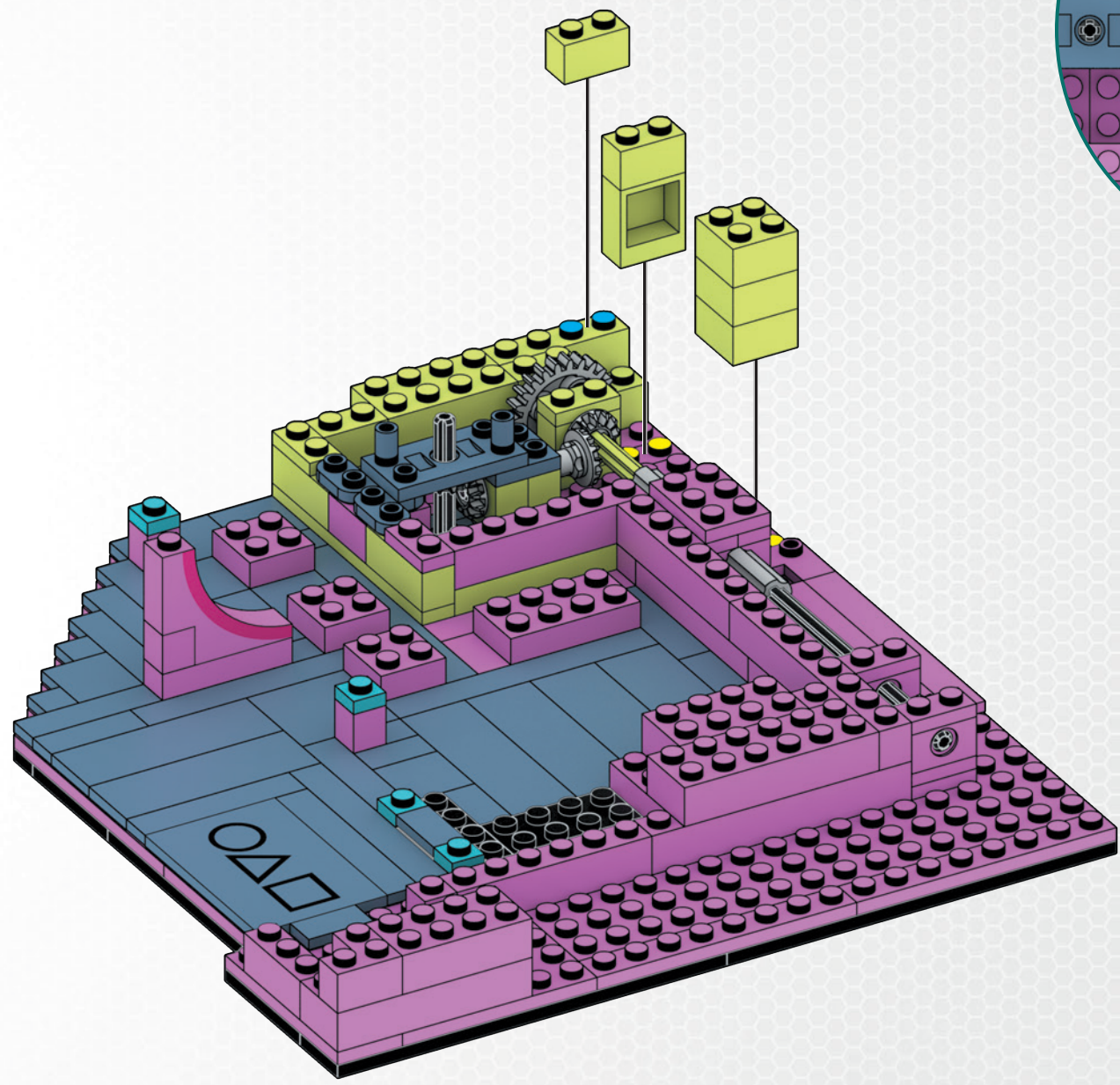
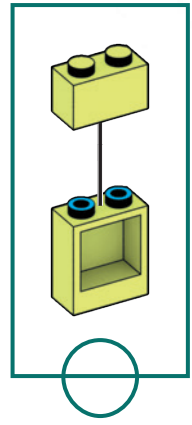
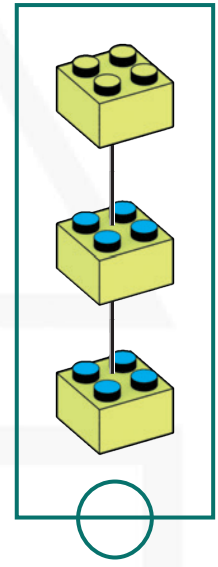

064

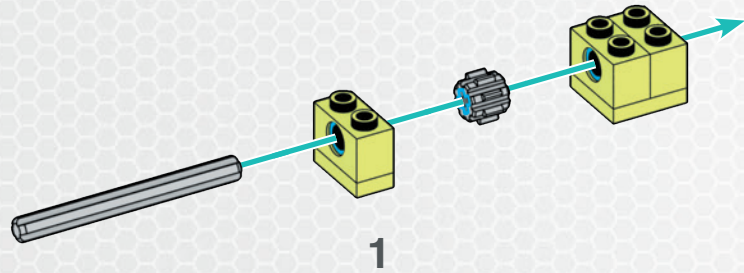
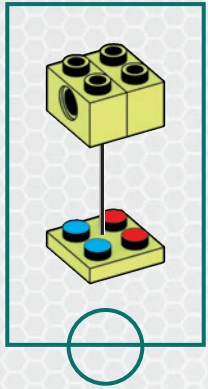
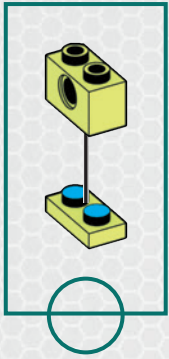

1

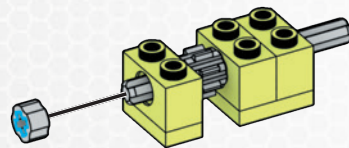

2

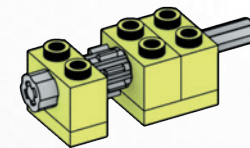

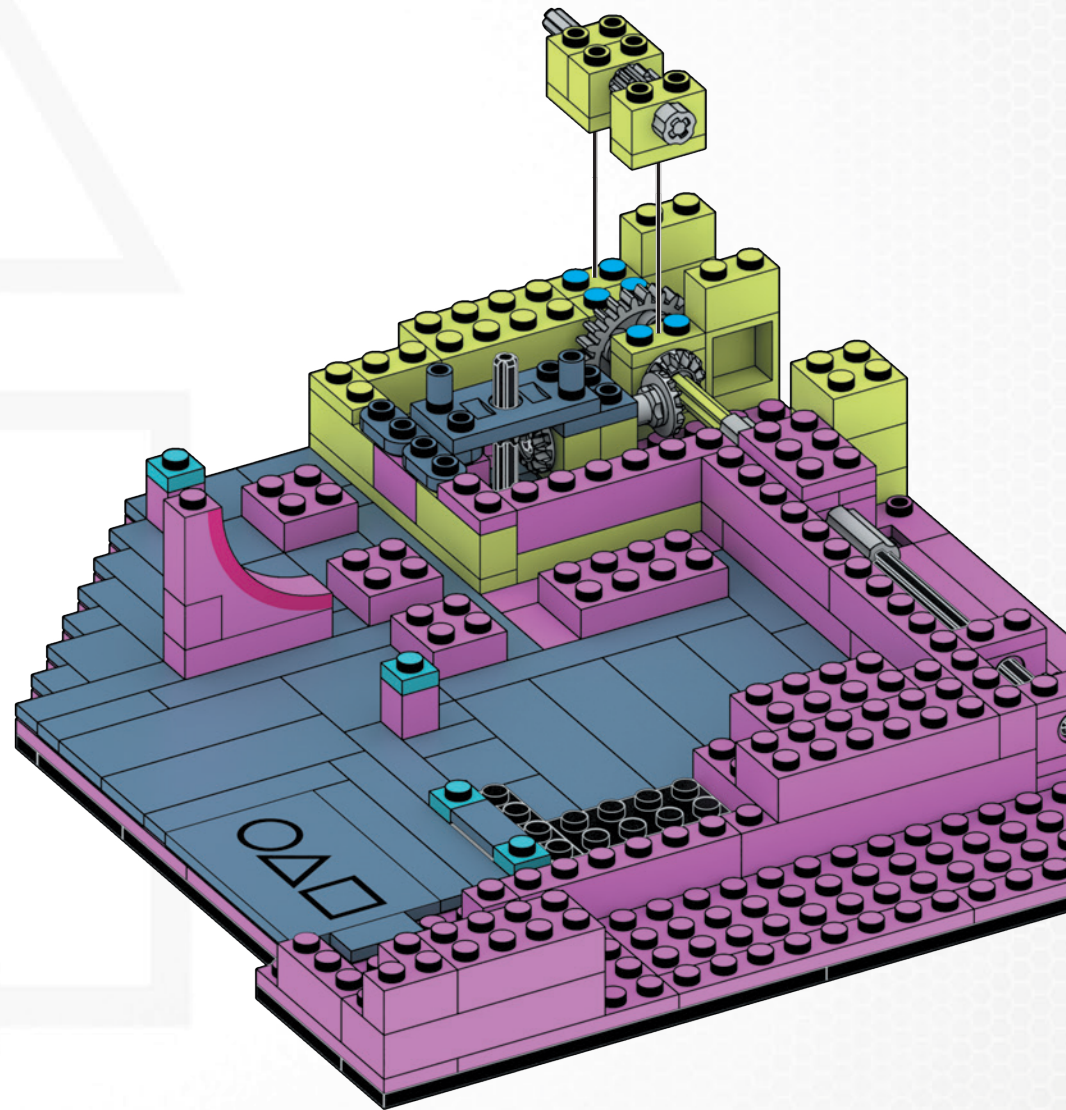

3

065

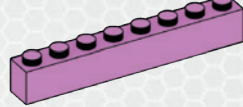

066

- 1x 
- 2x 
- 1x 

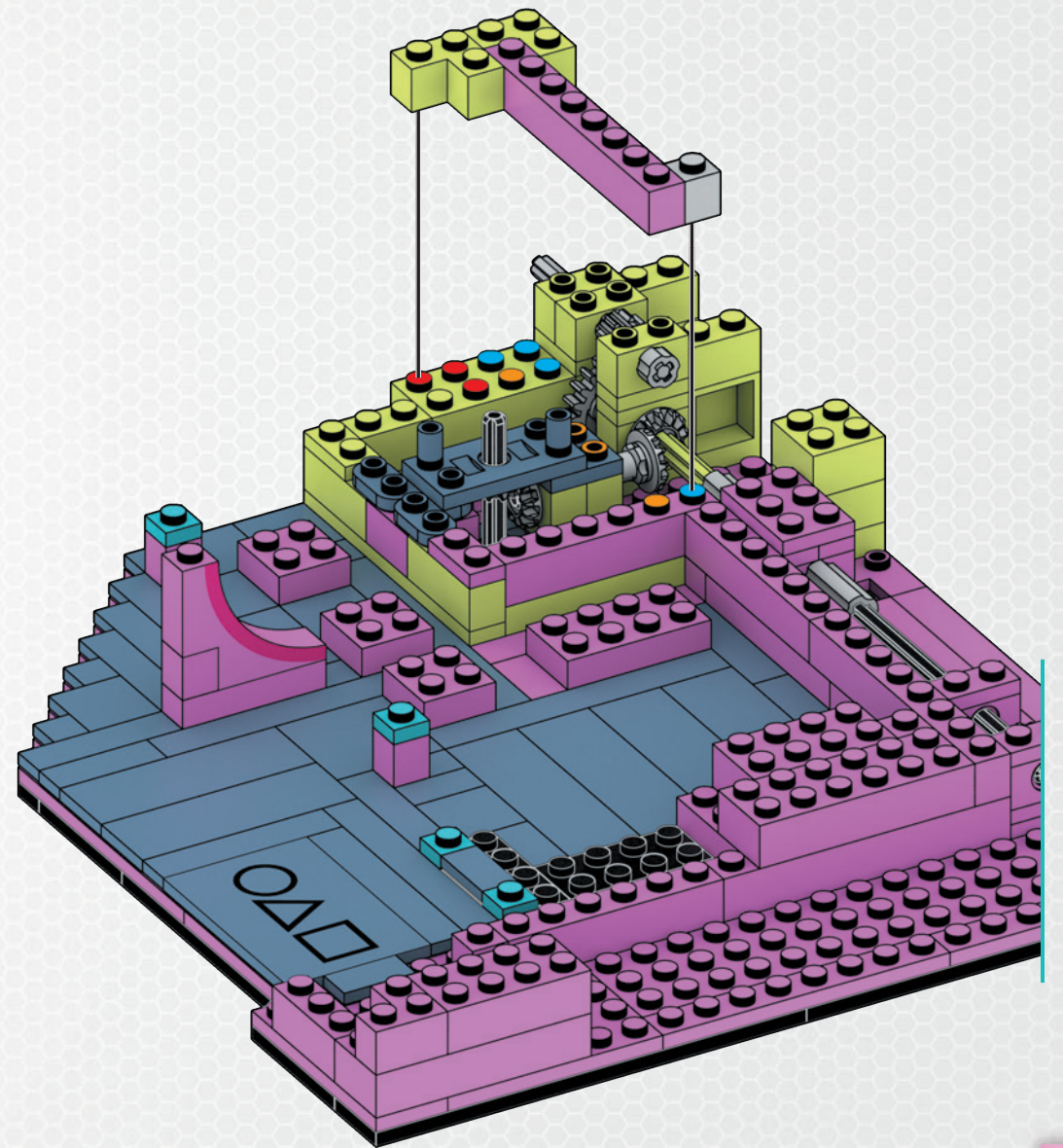

067



1x



1x

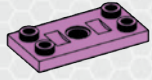

1x

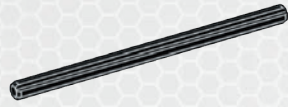

1x

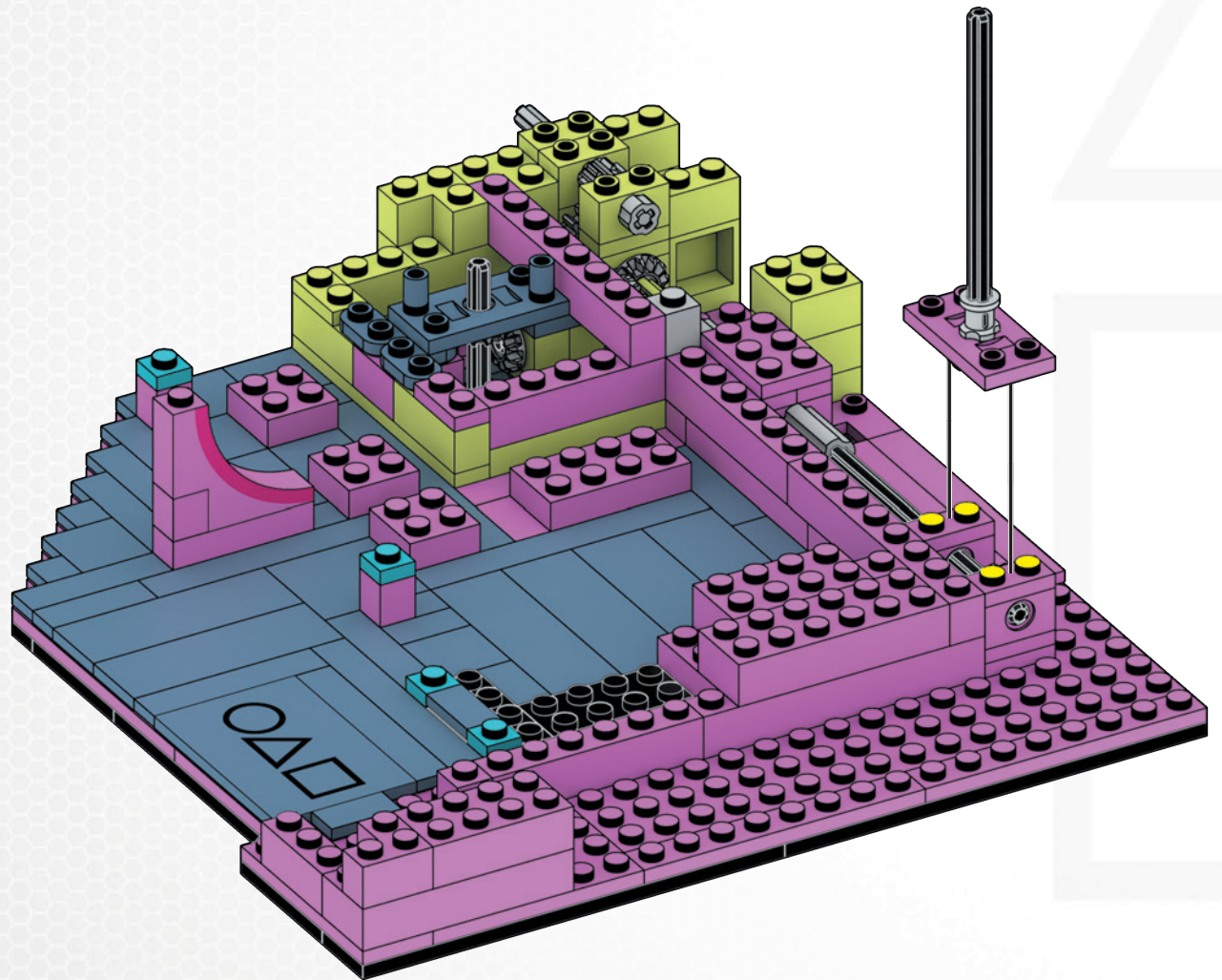
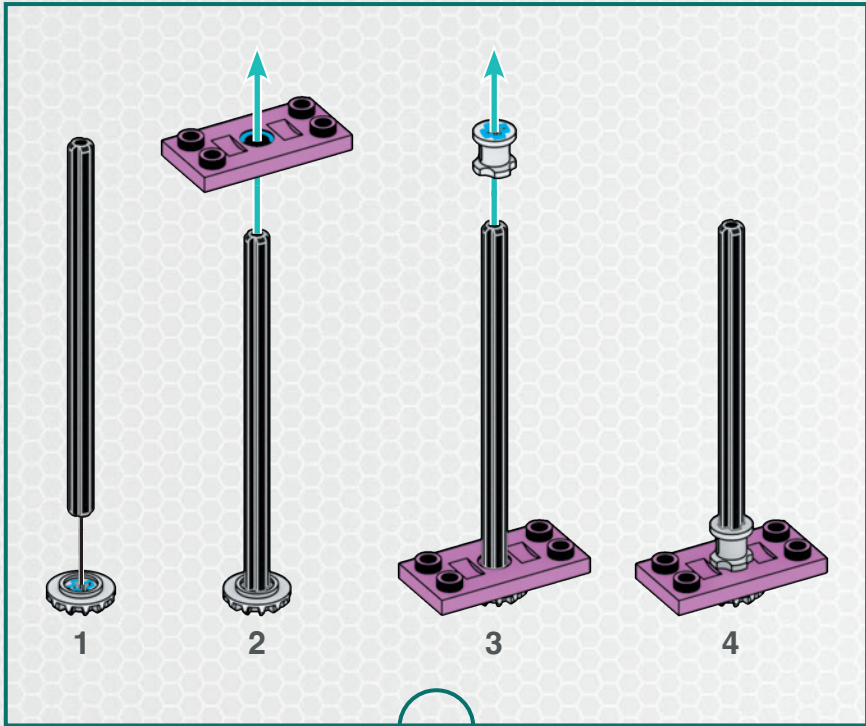

068

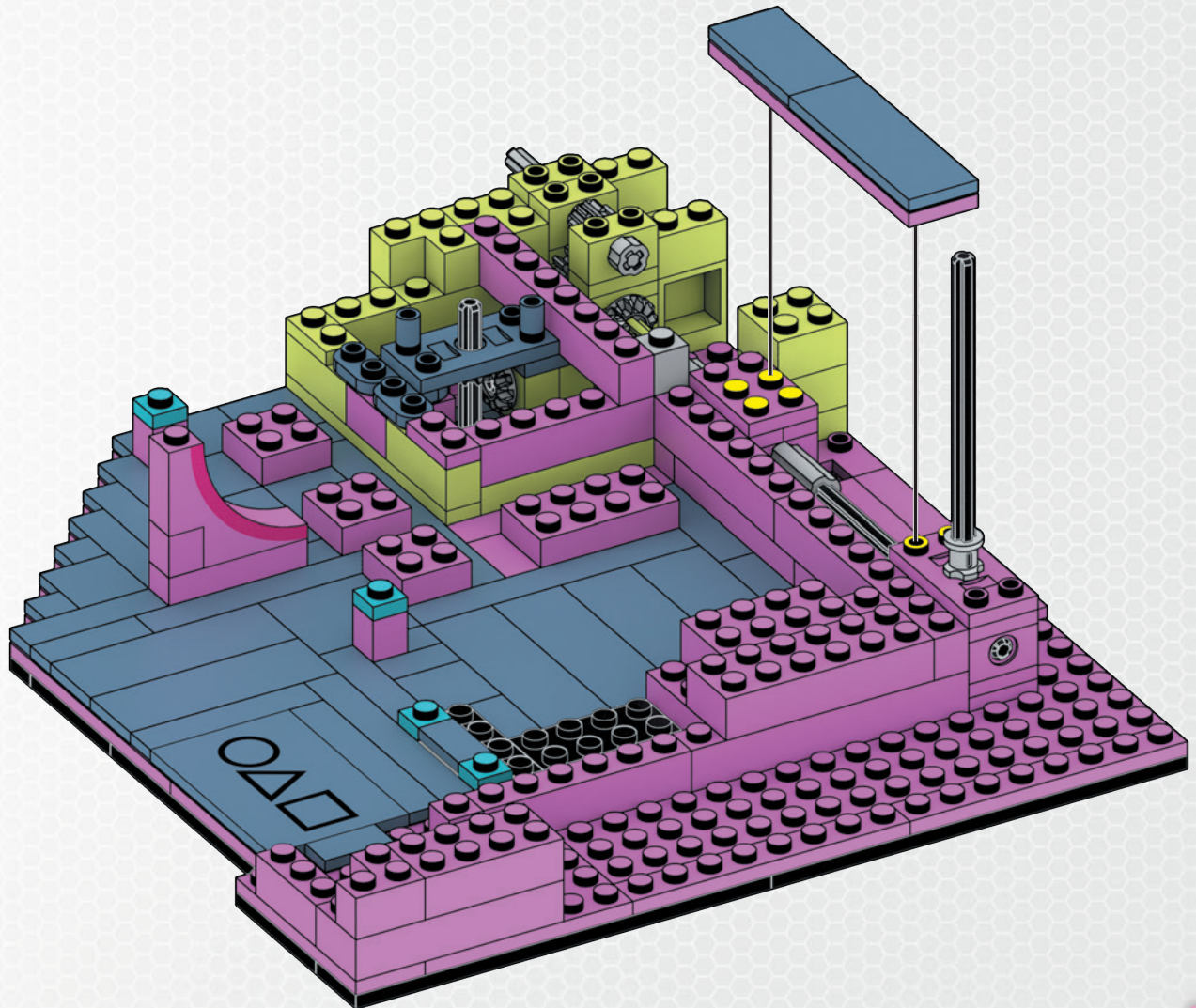
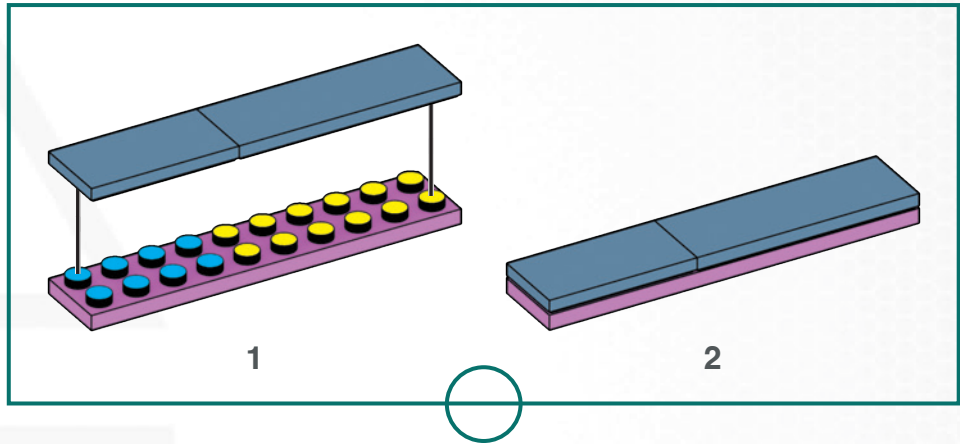
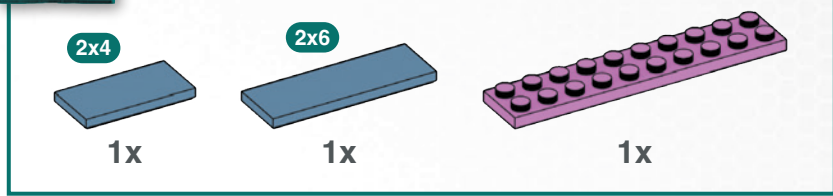

069

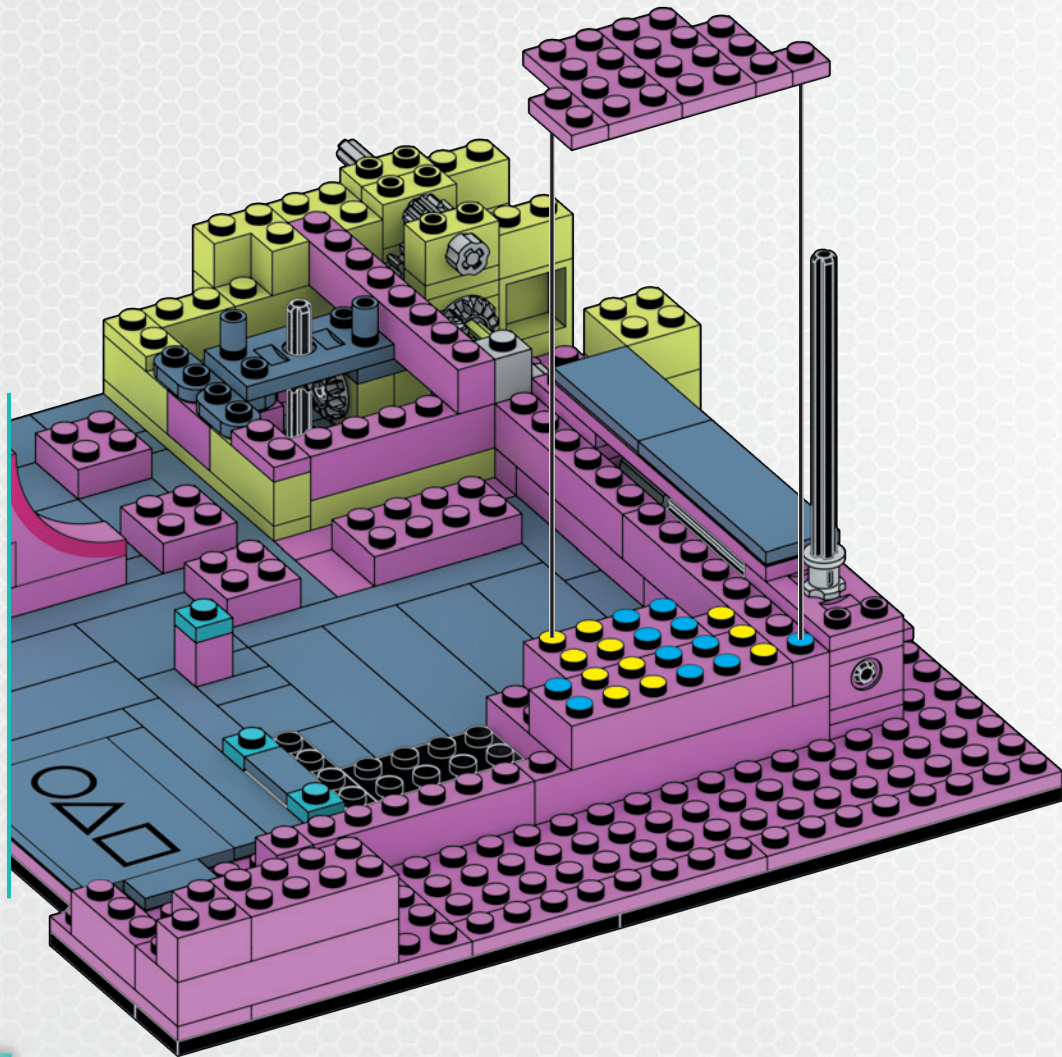
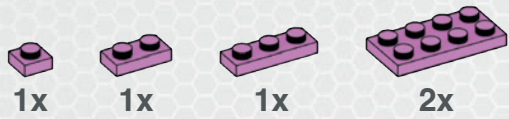

070

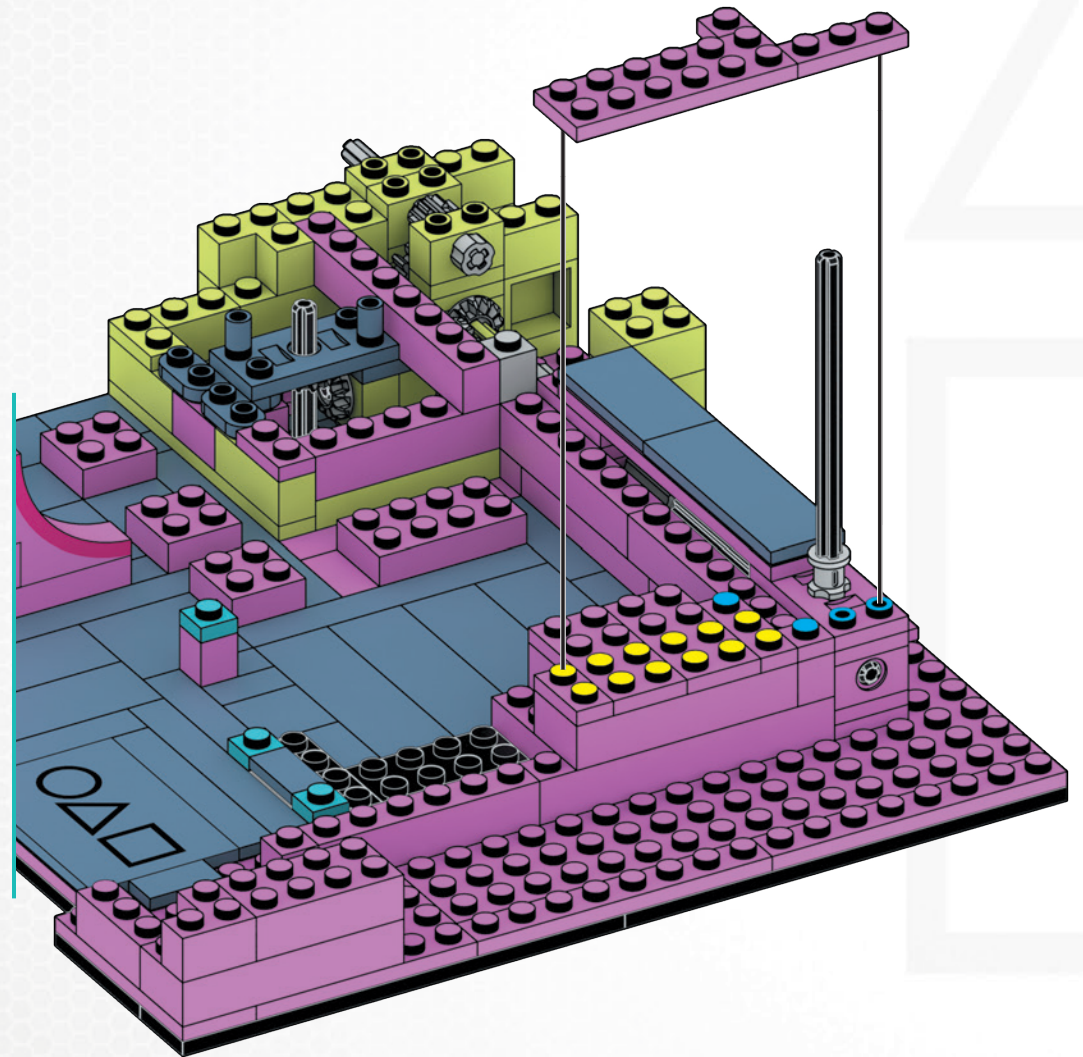
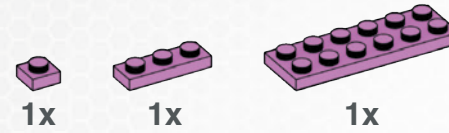

071

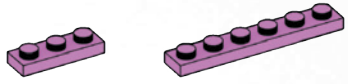

1x

1x

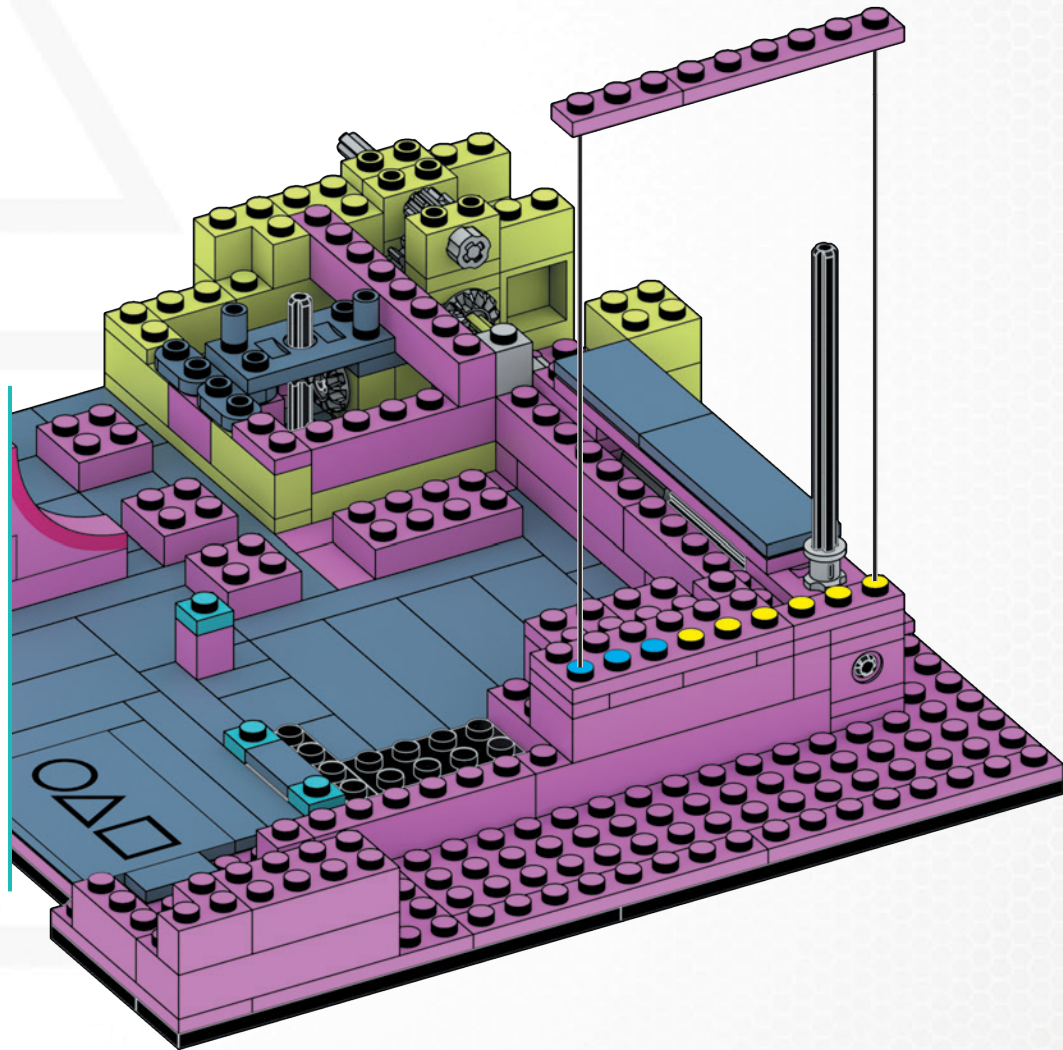

072



1x

1x

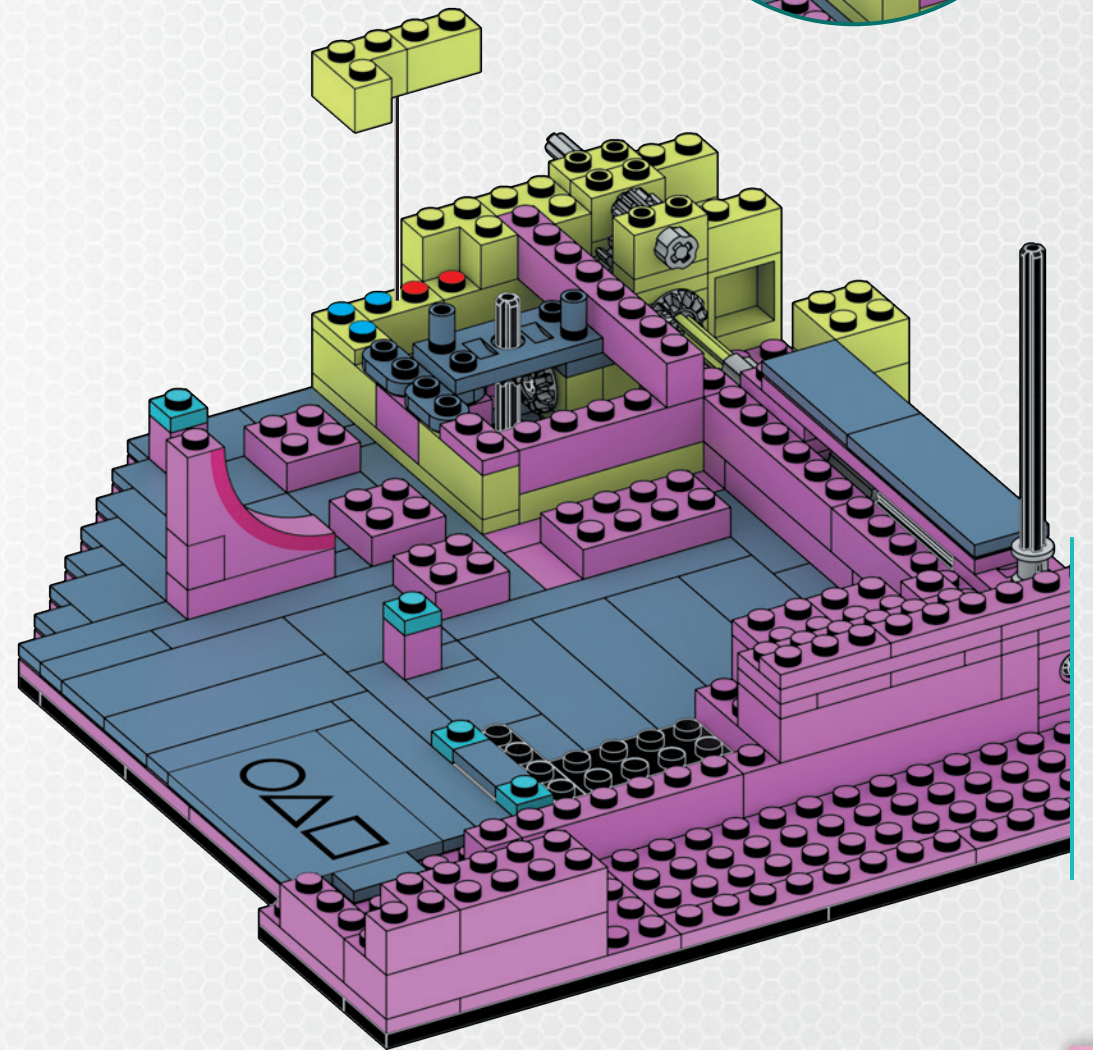



073

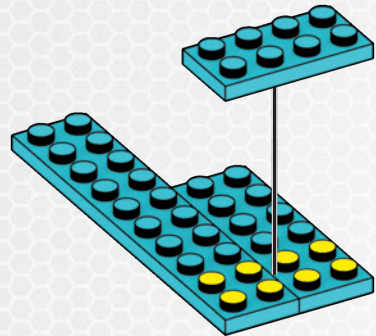
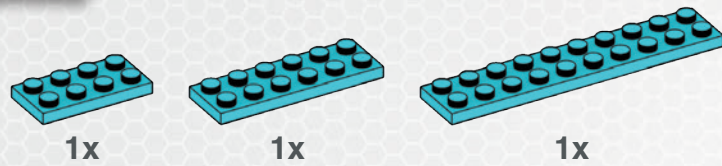

074

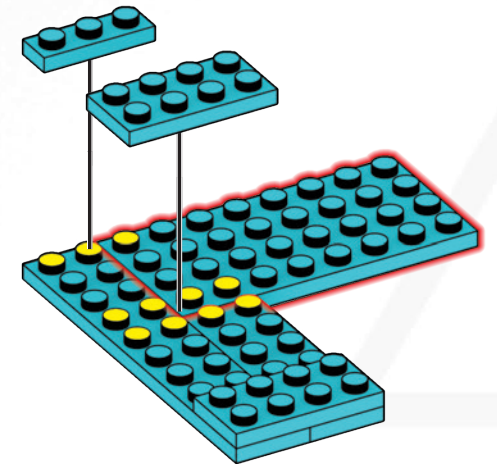
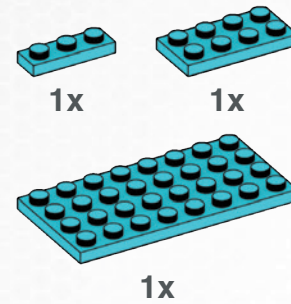

075

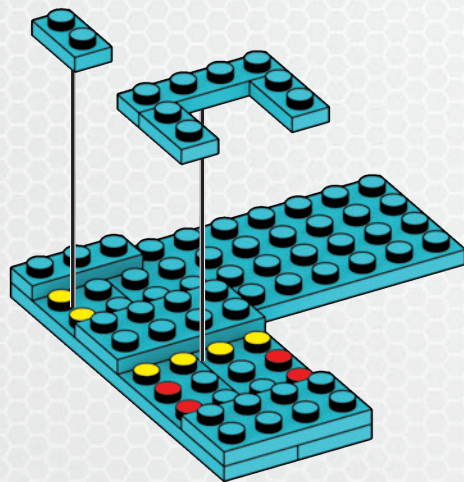

076

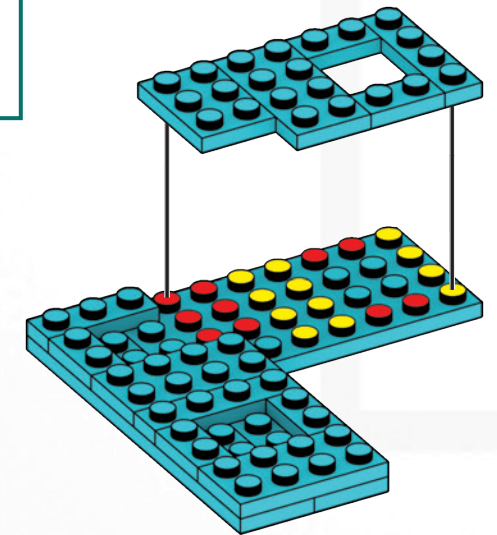
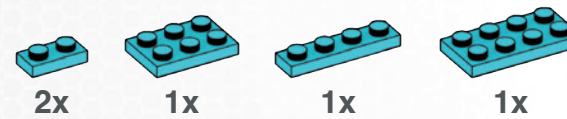

077

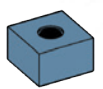

3x

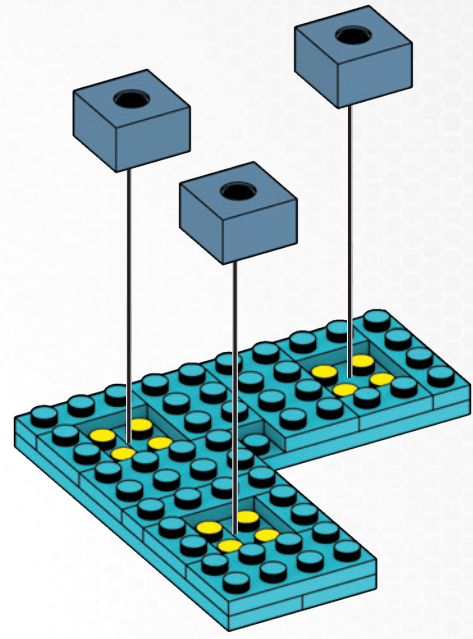

078

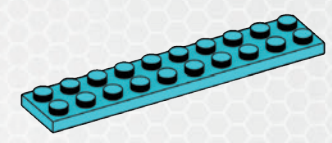

2x

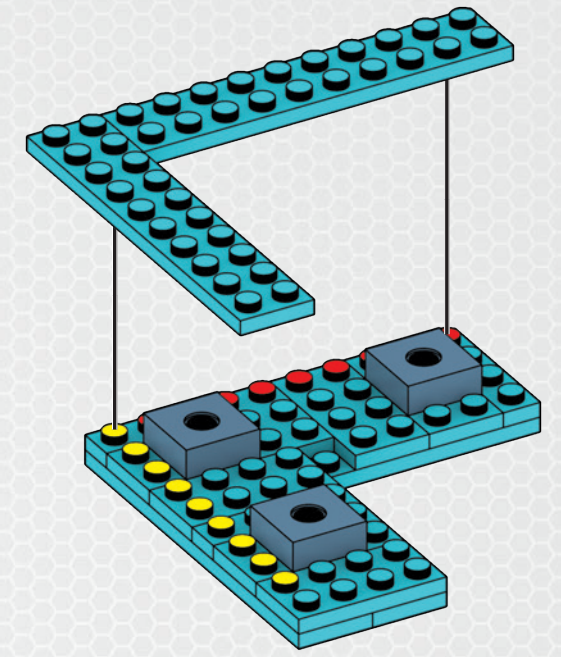

079

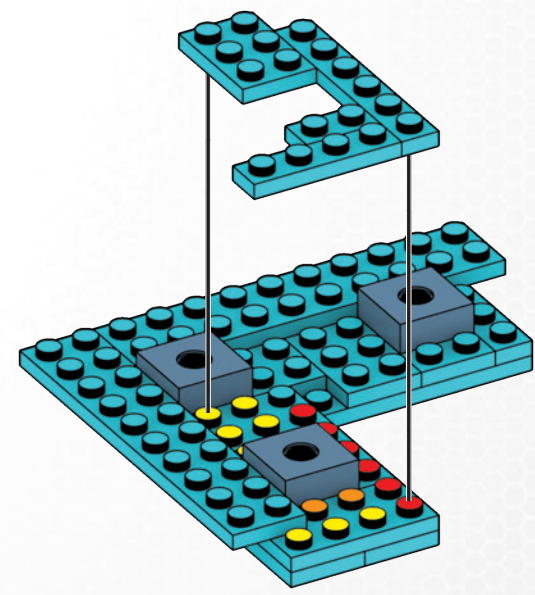
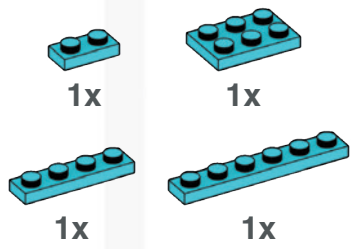

080

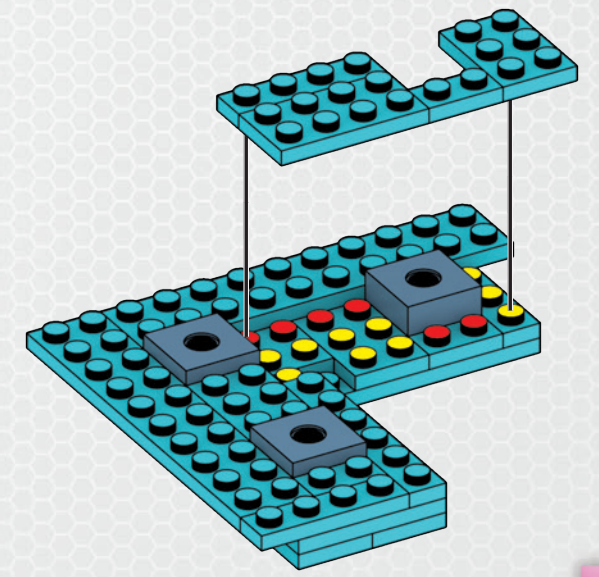
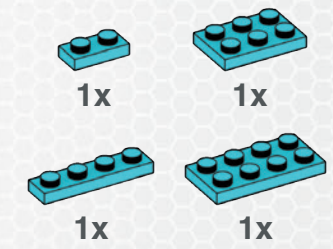

081

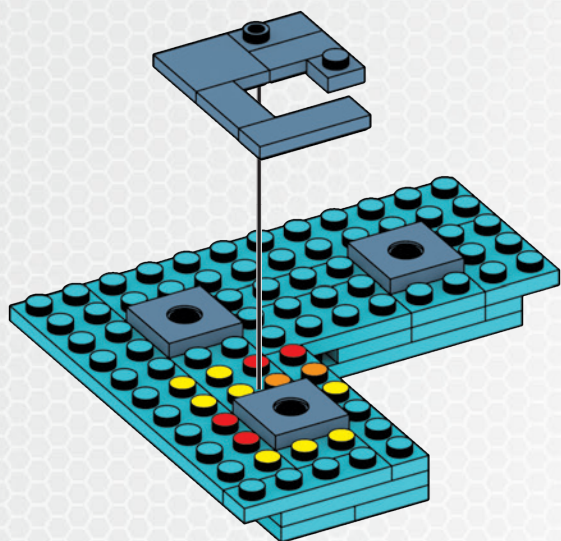
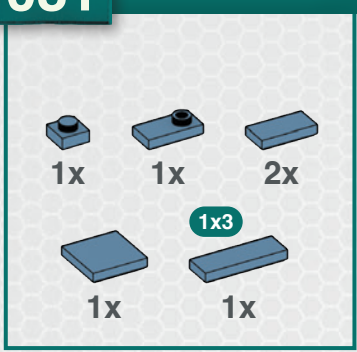

082

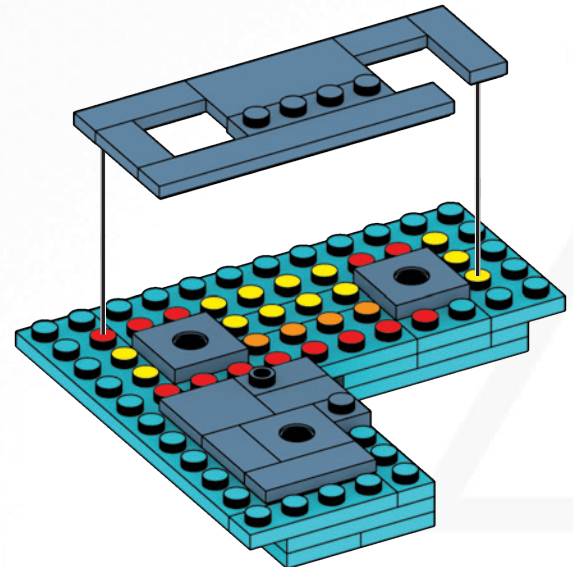
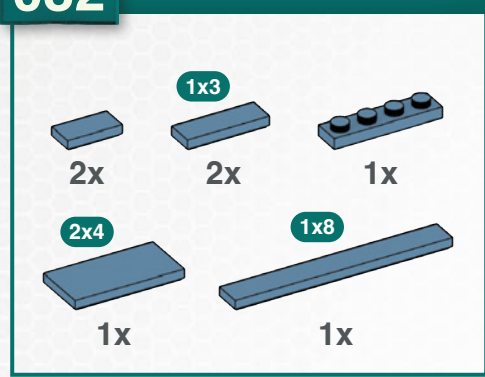

083

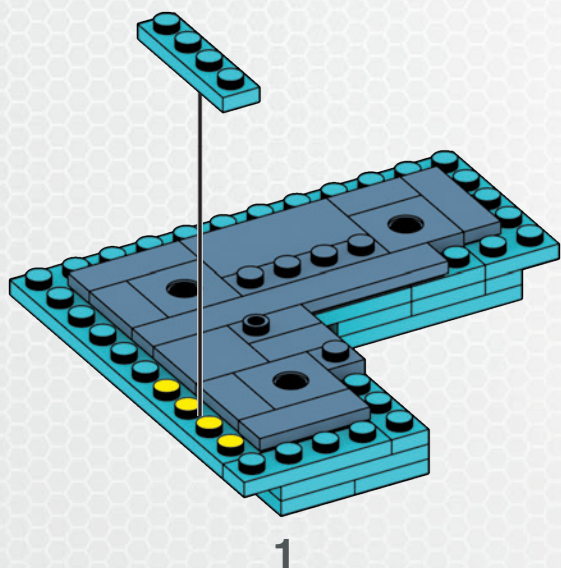

1

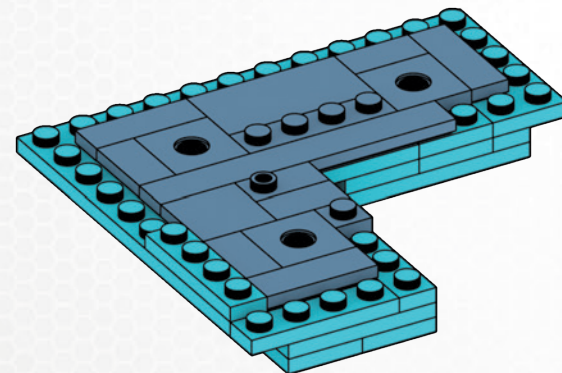

2

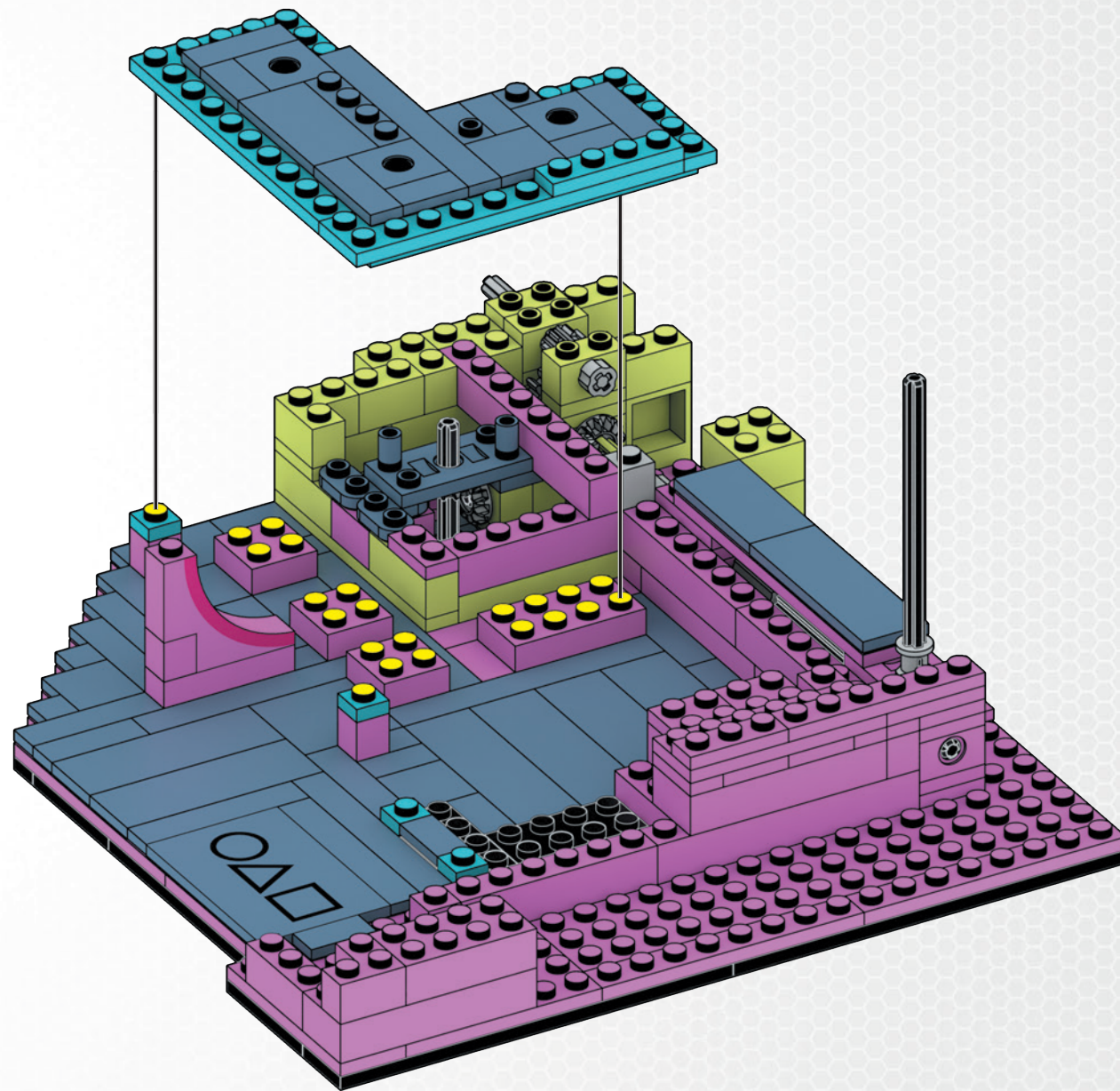

085



2x

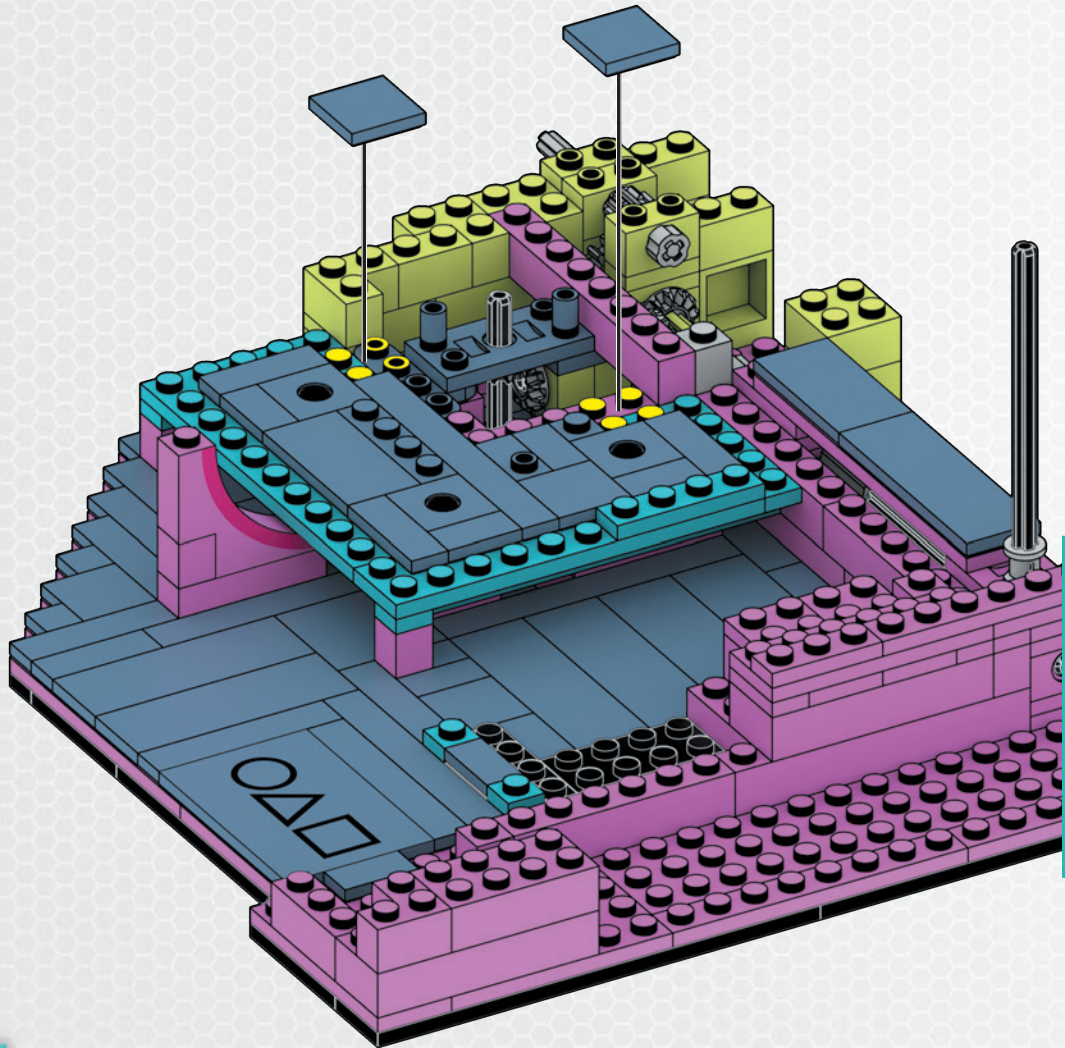

1

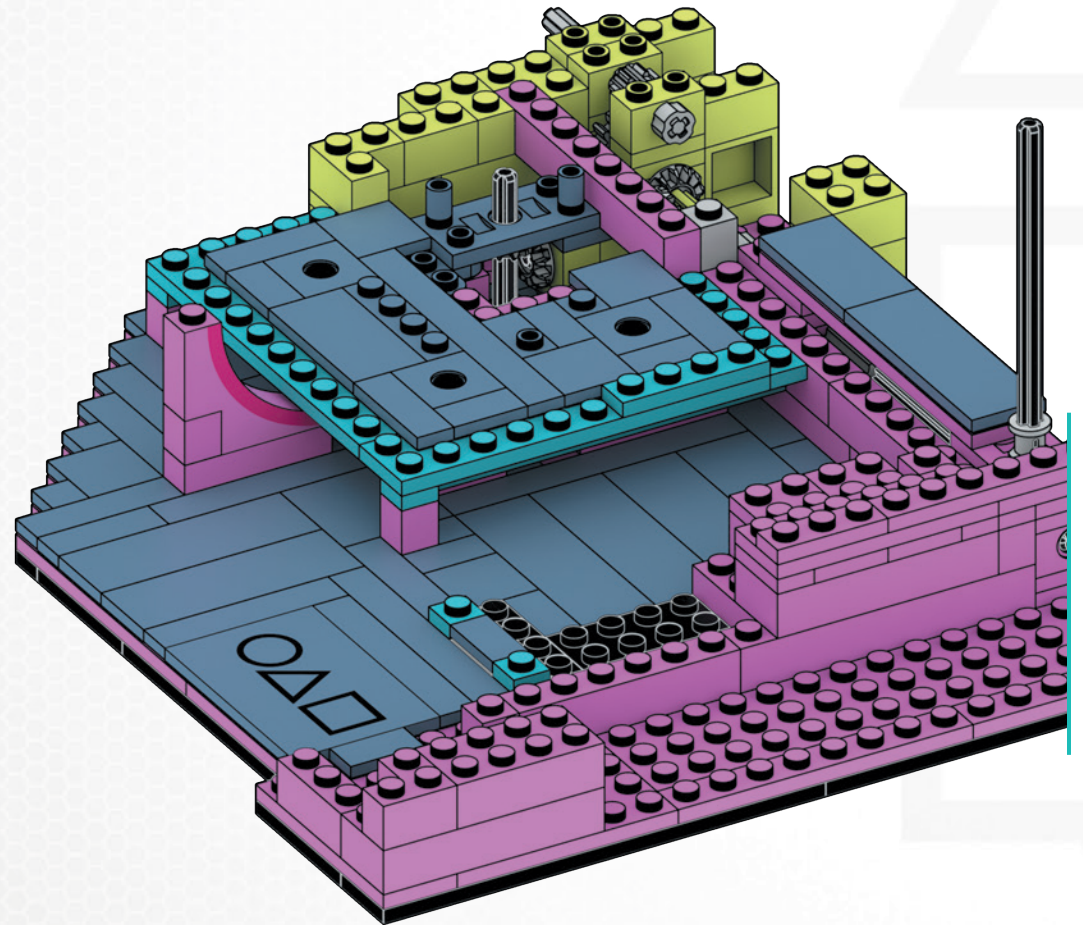

2

086

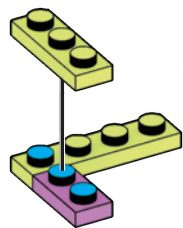
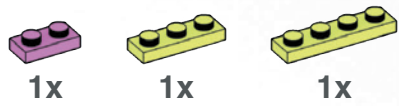

087

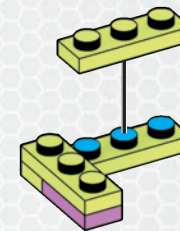

088

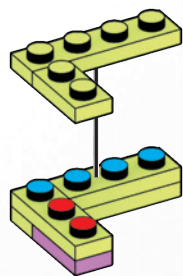
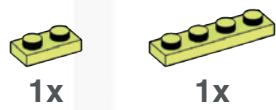

089

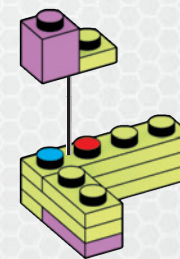

1

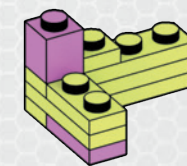

2

090

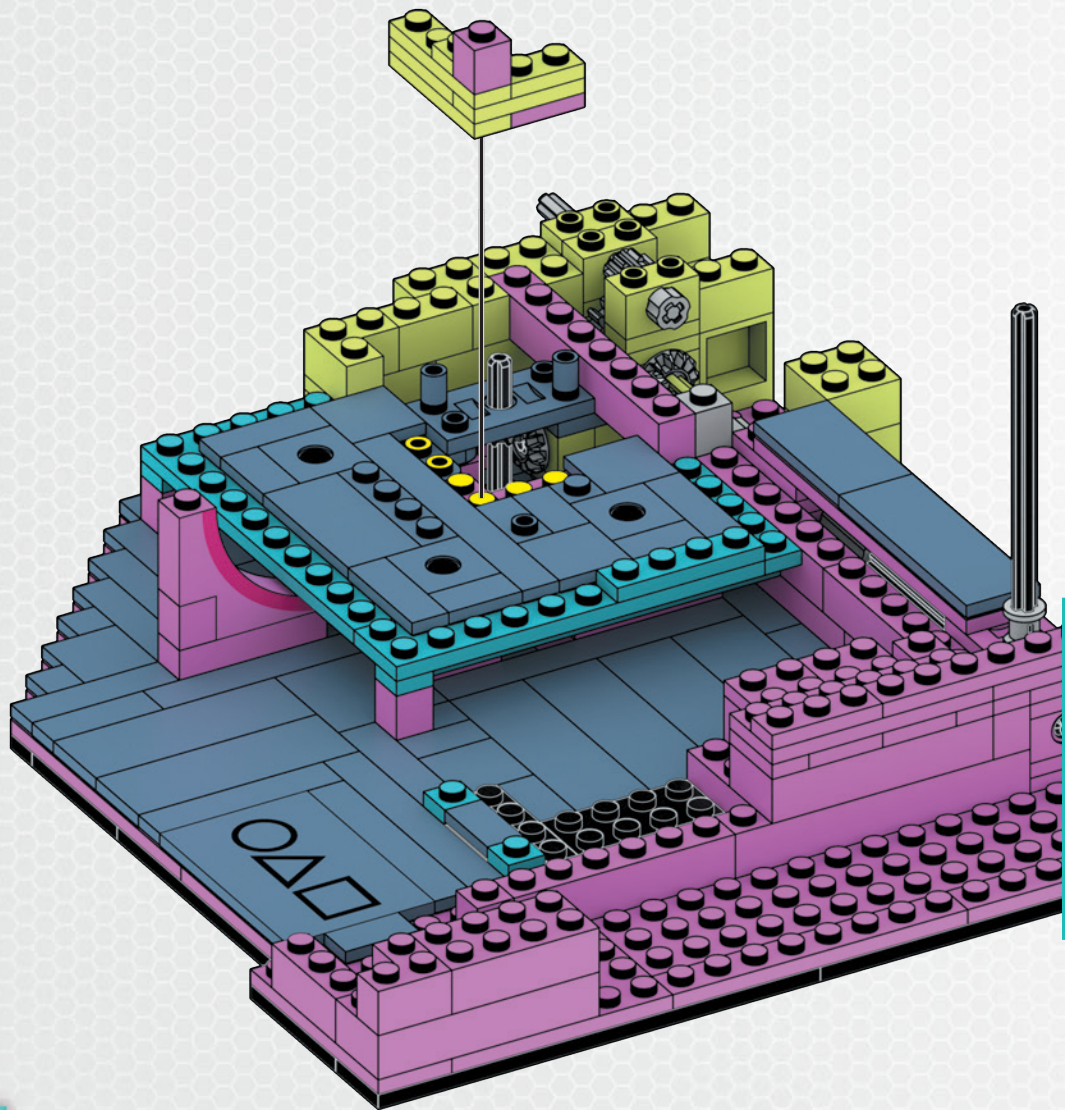

091



3x

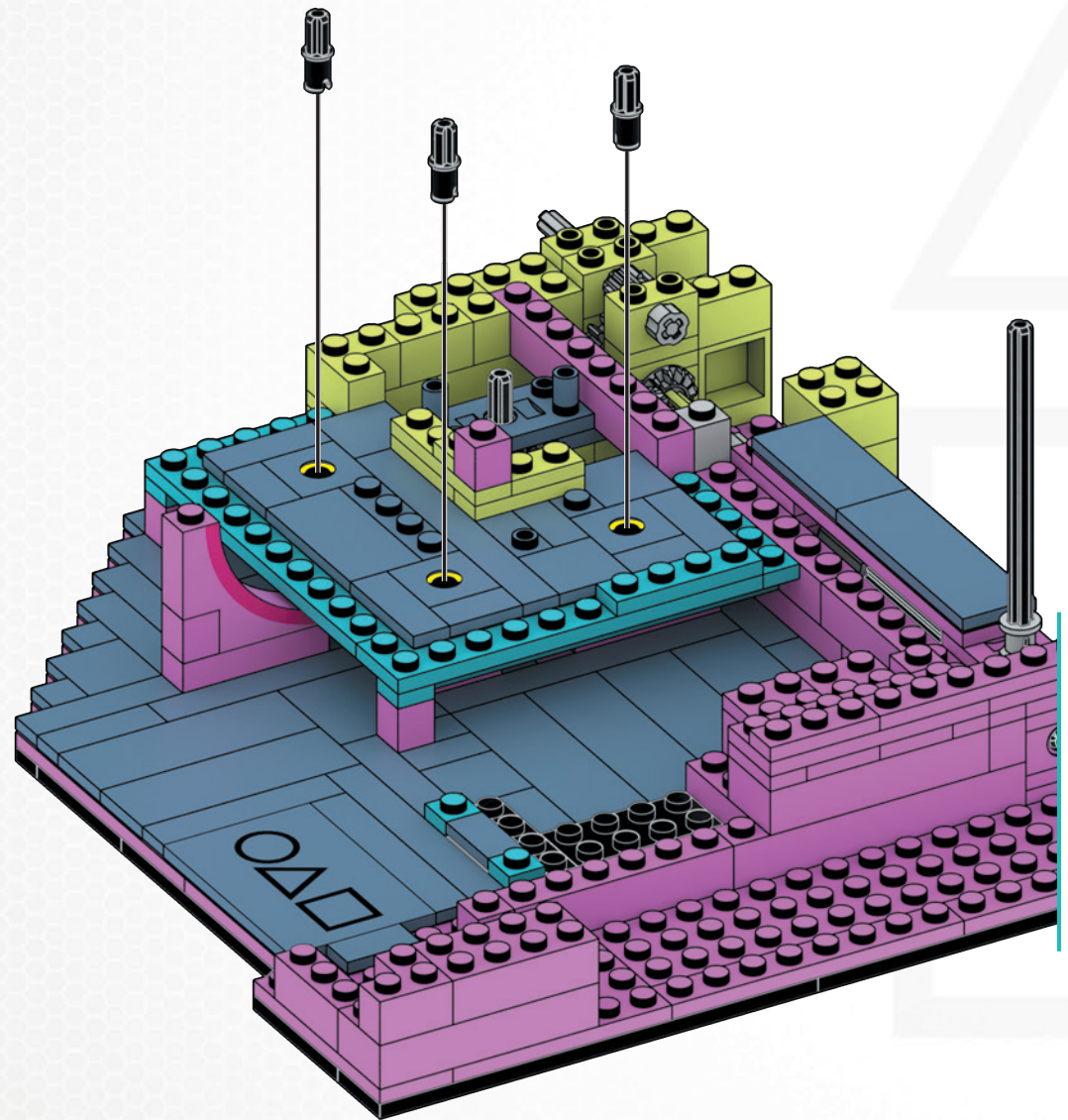

092



4x

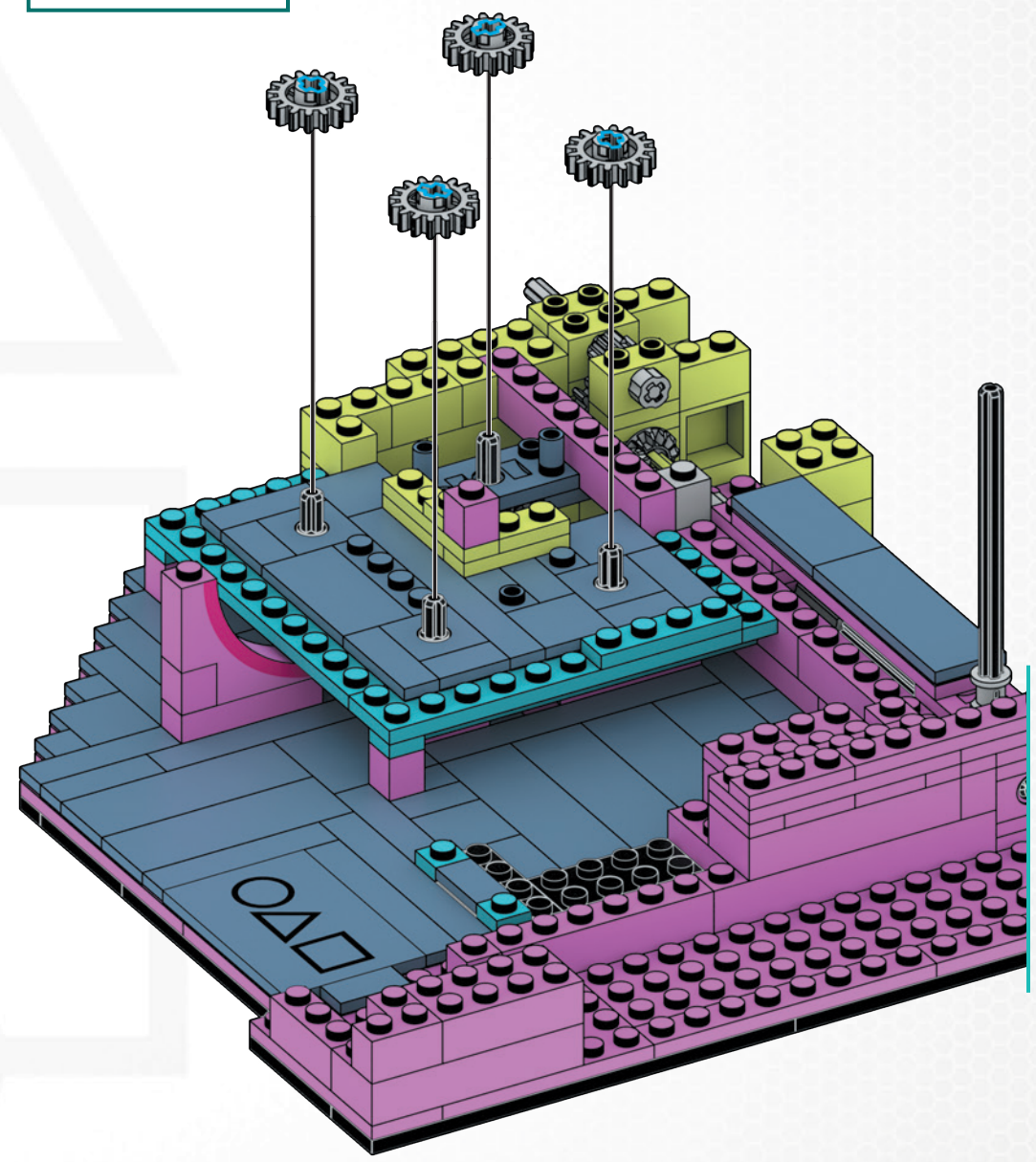

1

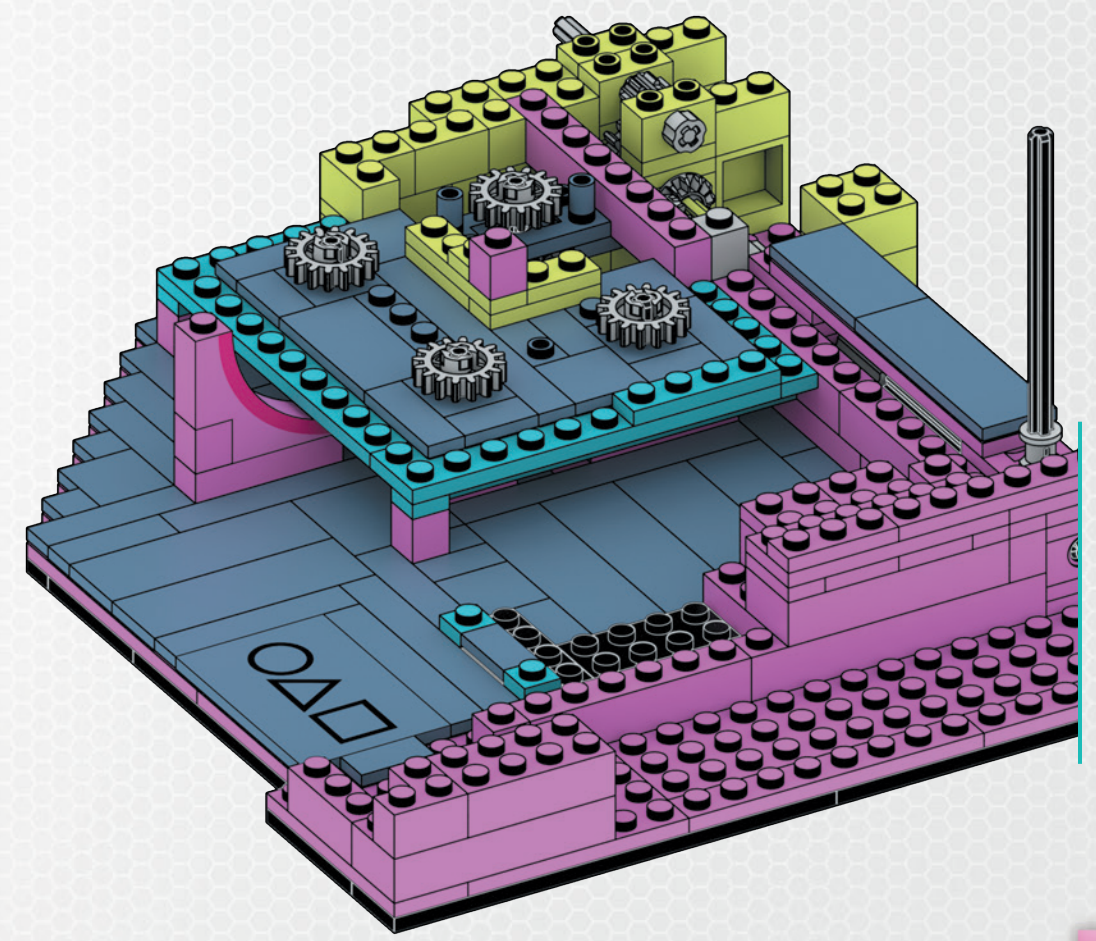

2

093



22x



11x

x11

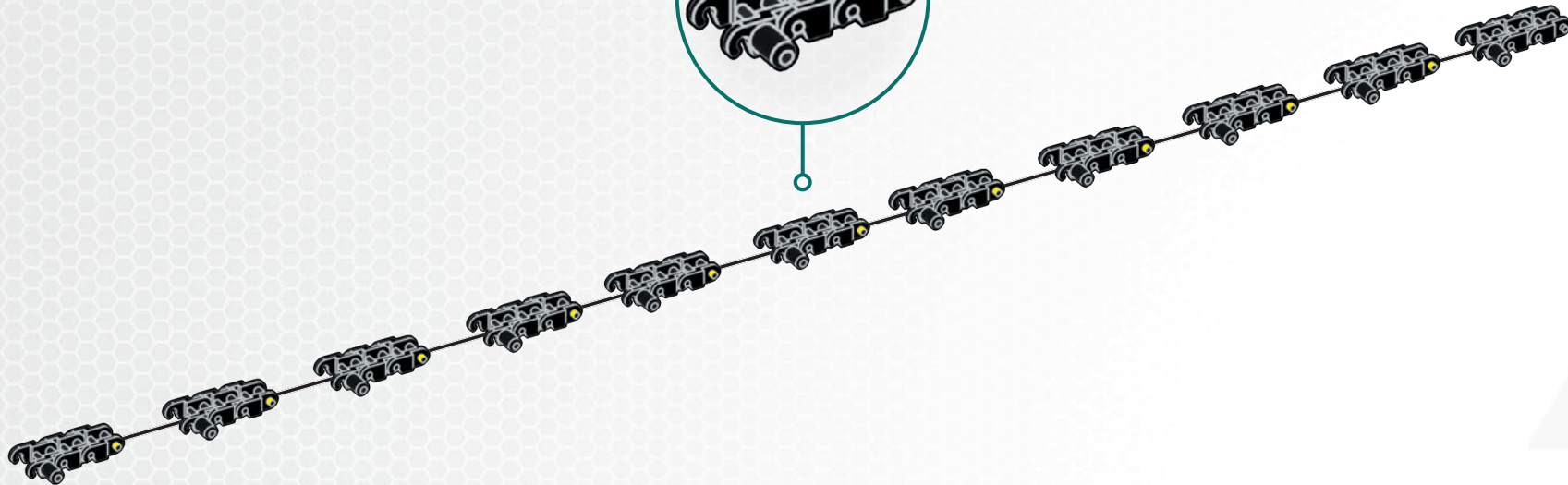

094



1x



1x

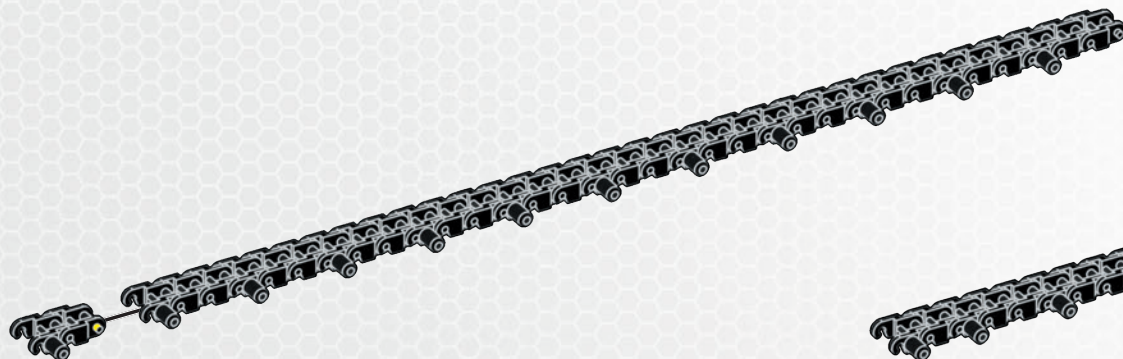

1

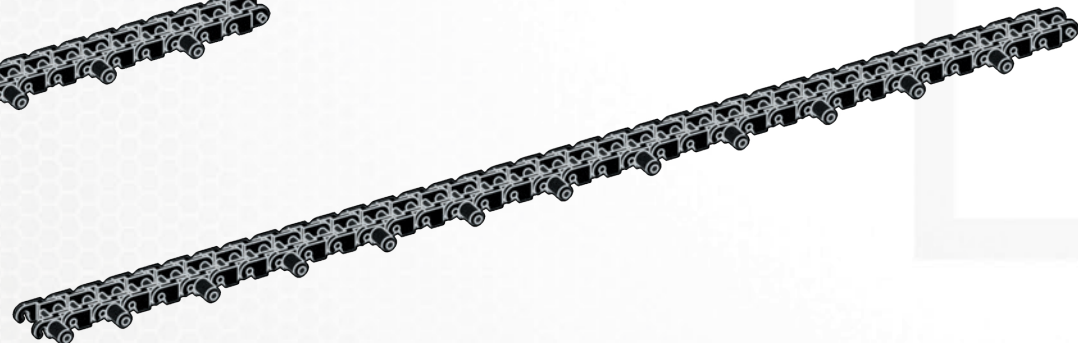

2

095



11x



1x

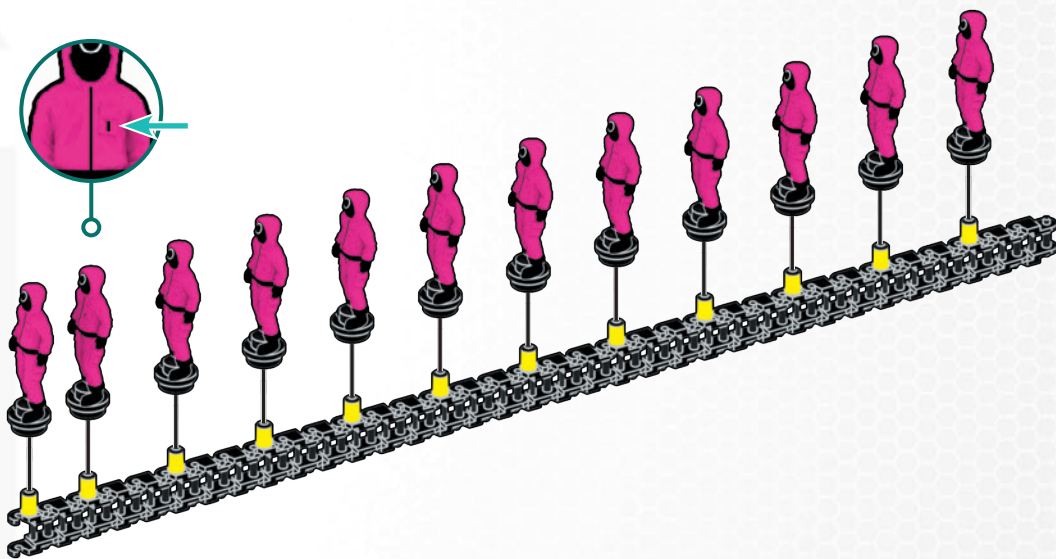

1

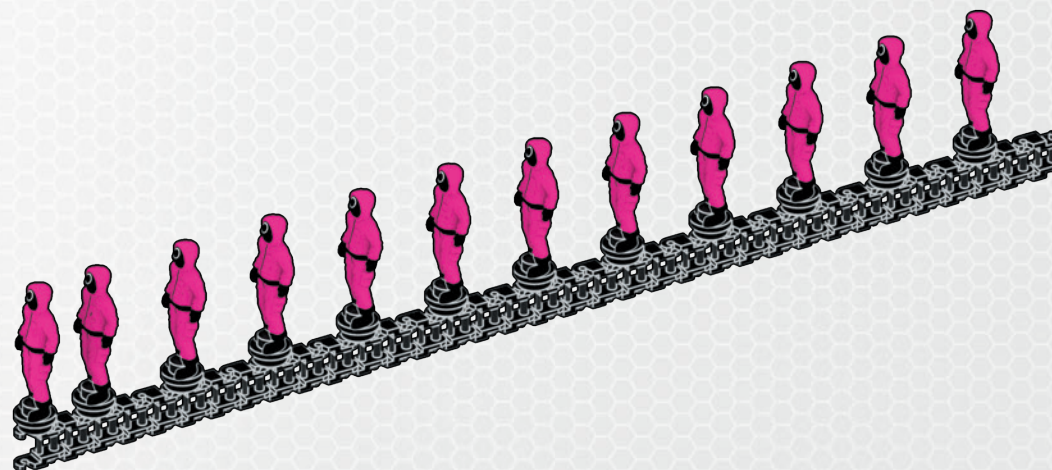

2

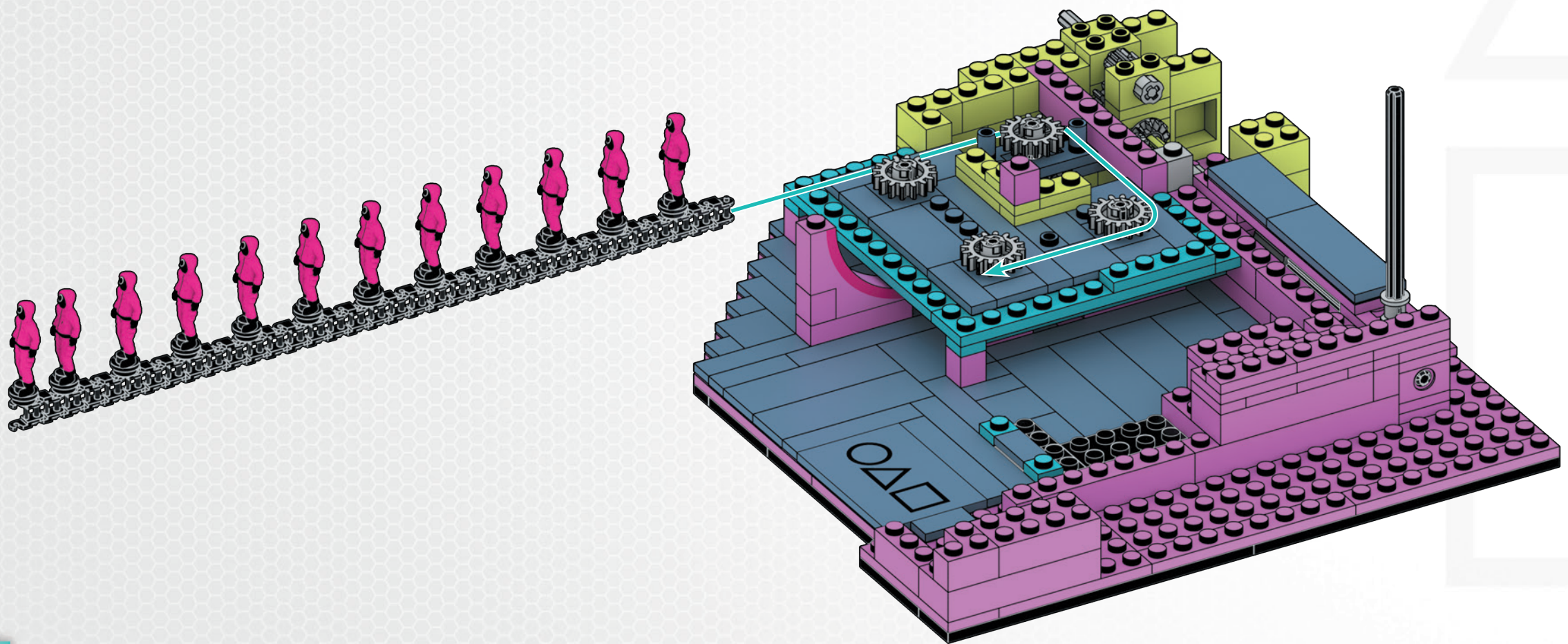

1

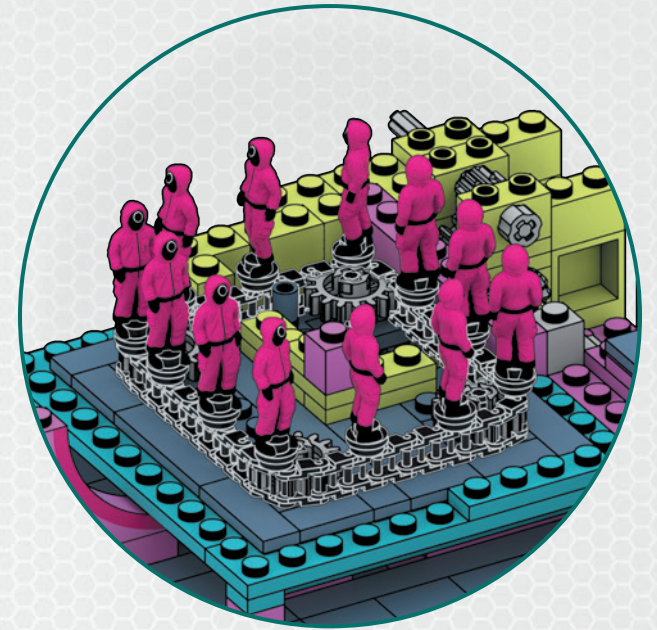
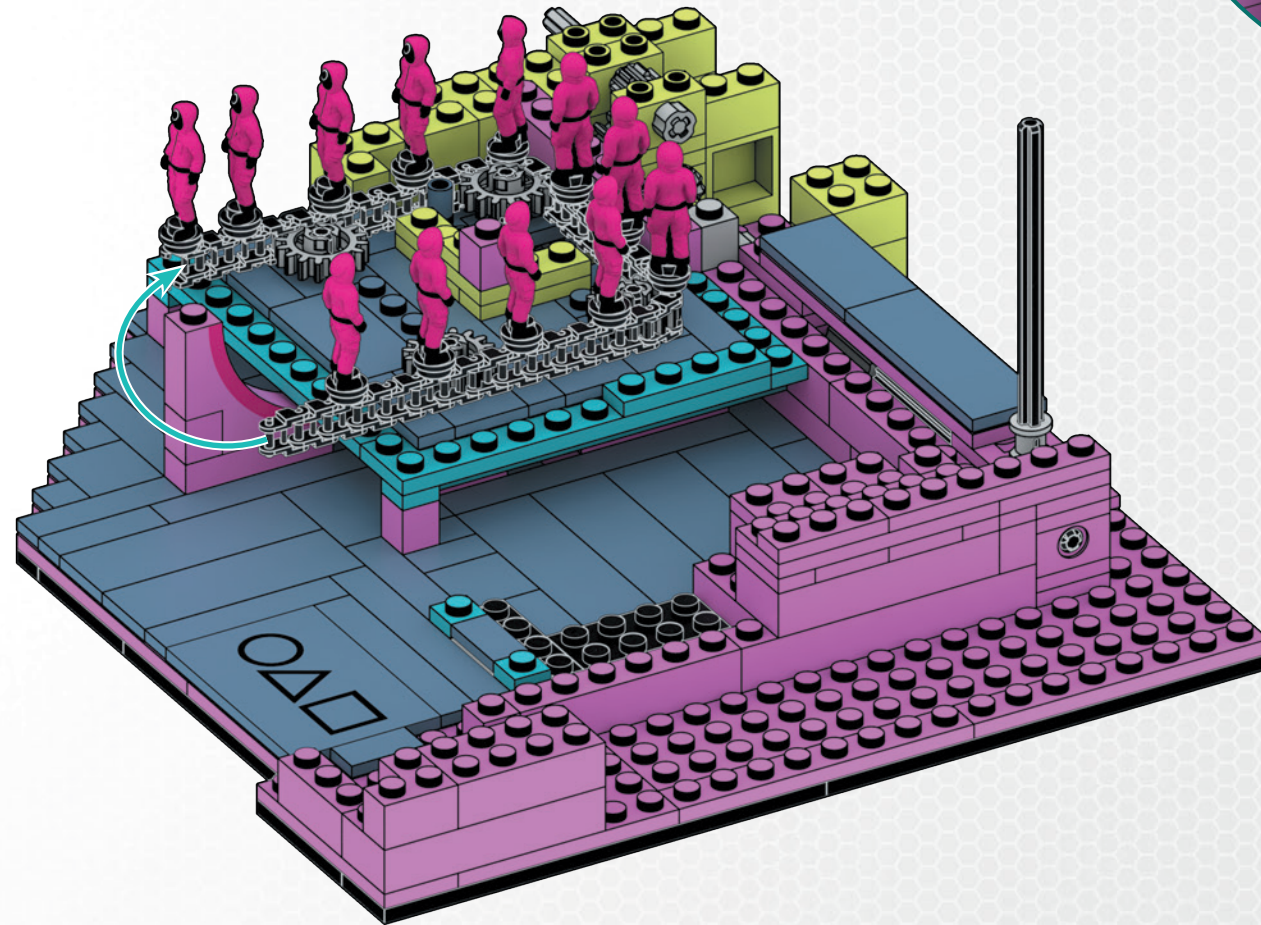

2

097

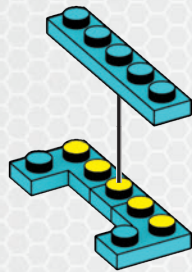

098

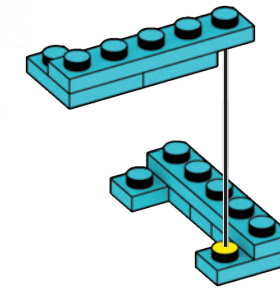
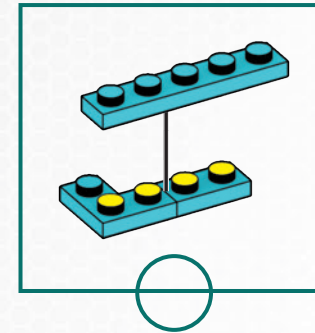

099

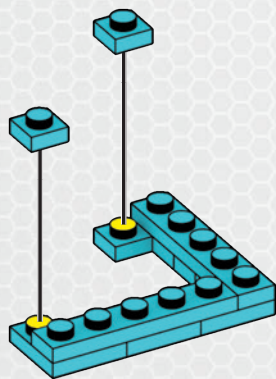

100

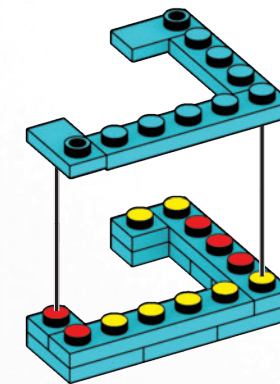
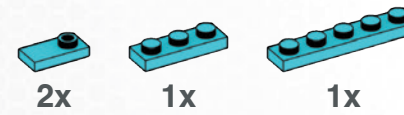

101

1x5

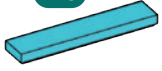

2x

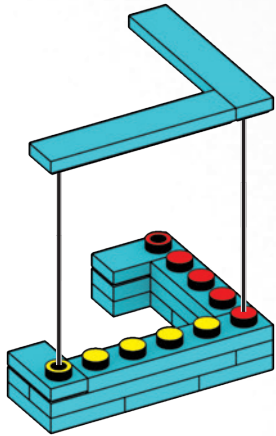

1

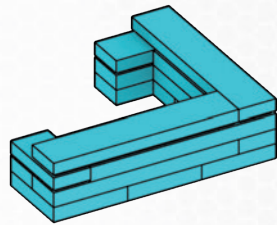

2

102



1x



1x

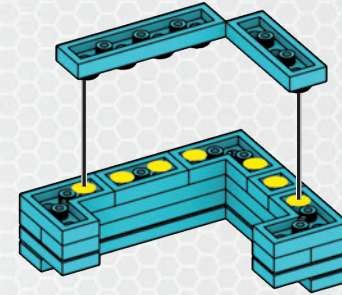

103



2x



2x

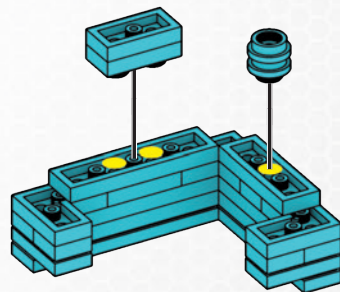
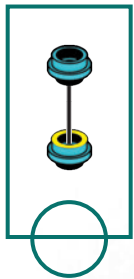
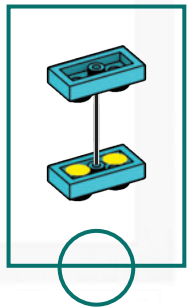

1

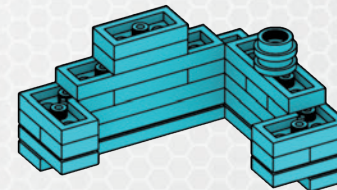

2

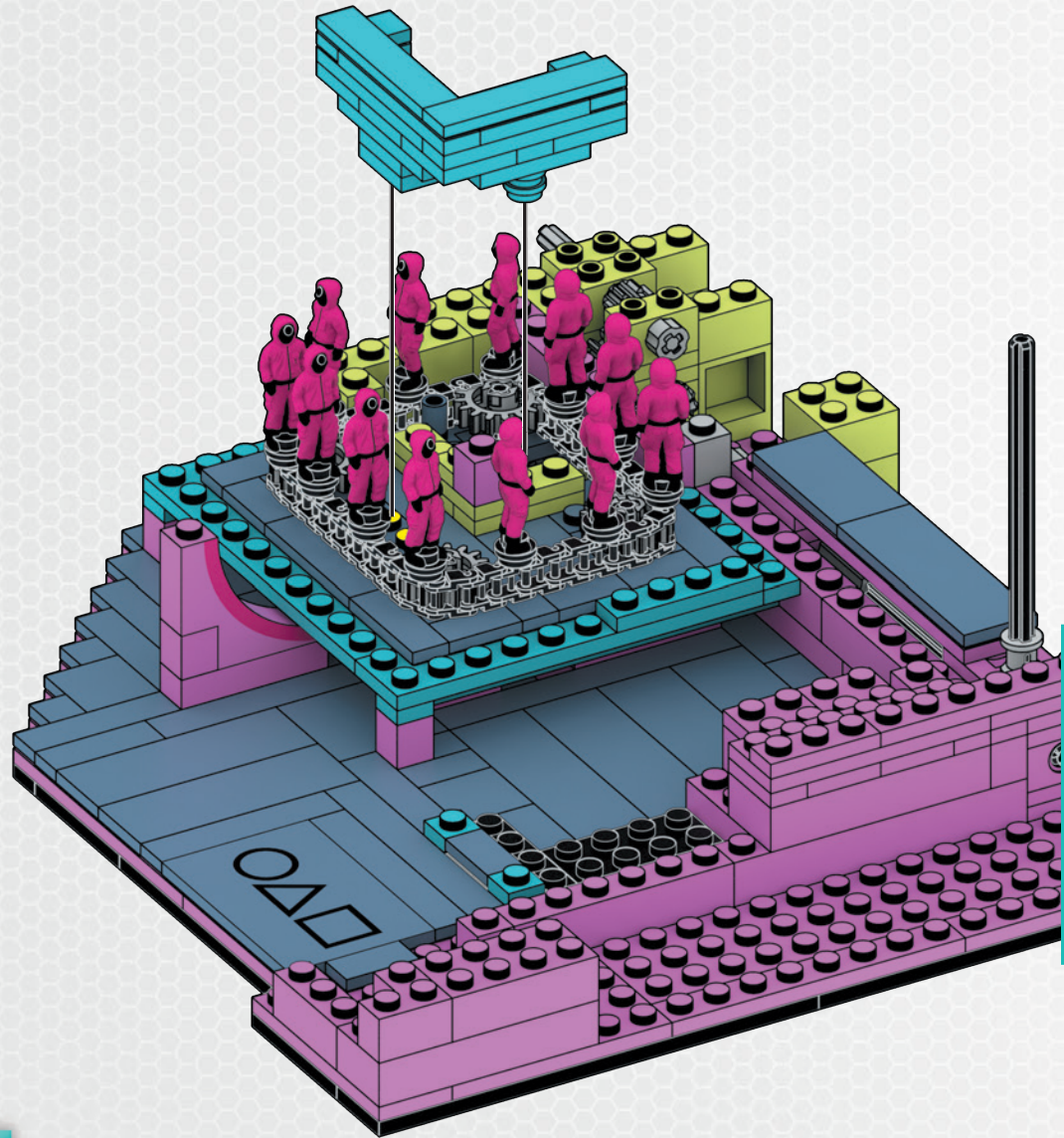

1

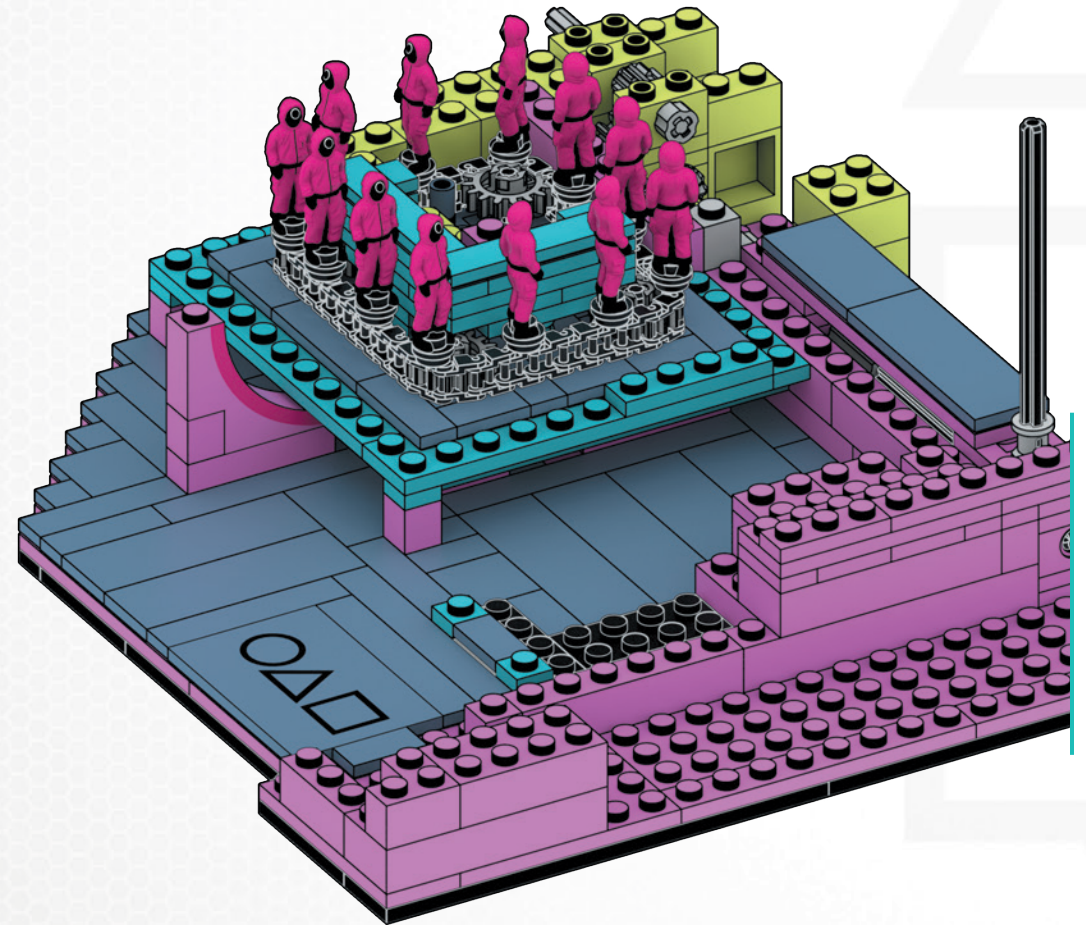
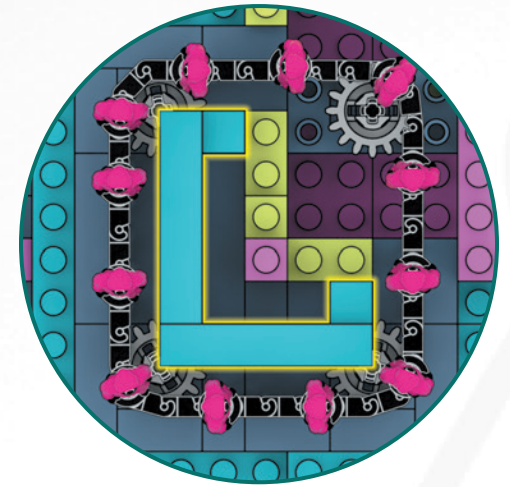

2

105

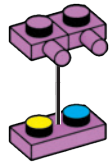
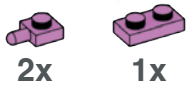

106

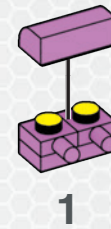

107

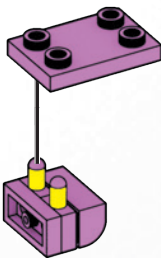
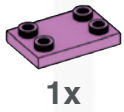

108

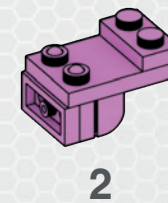
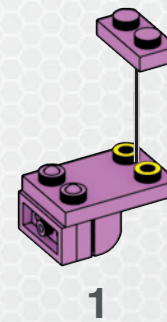

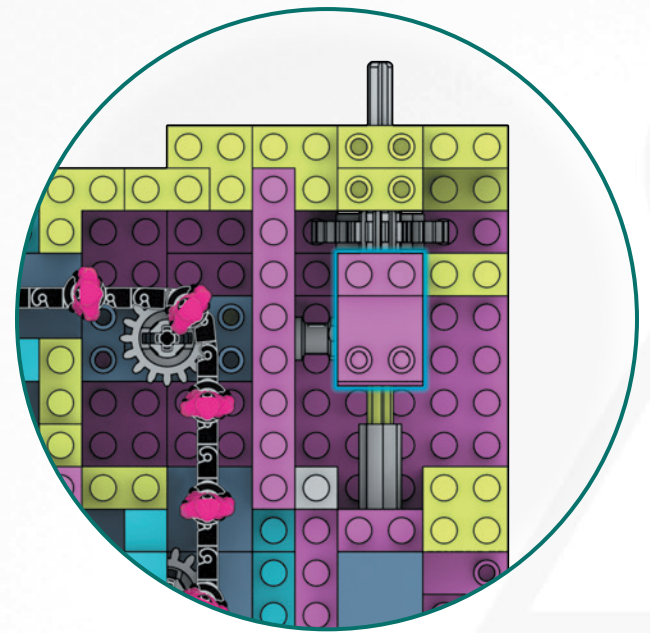
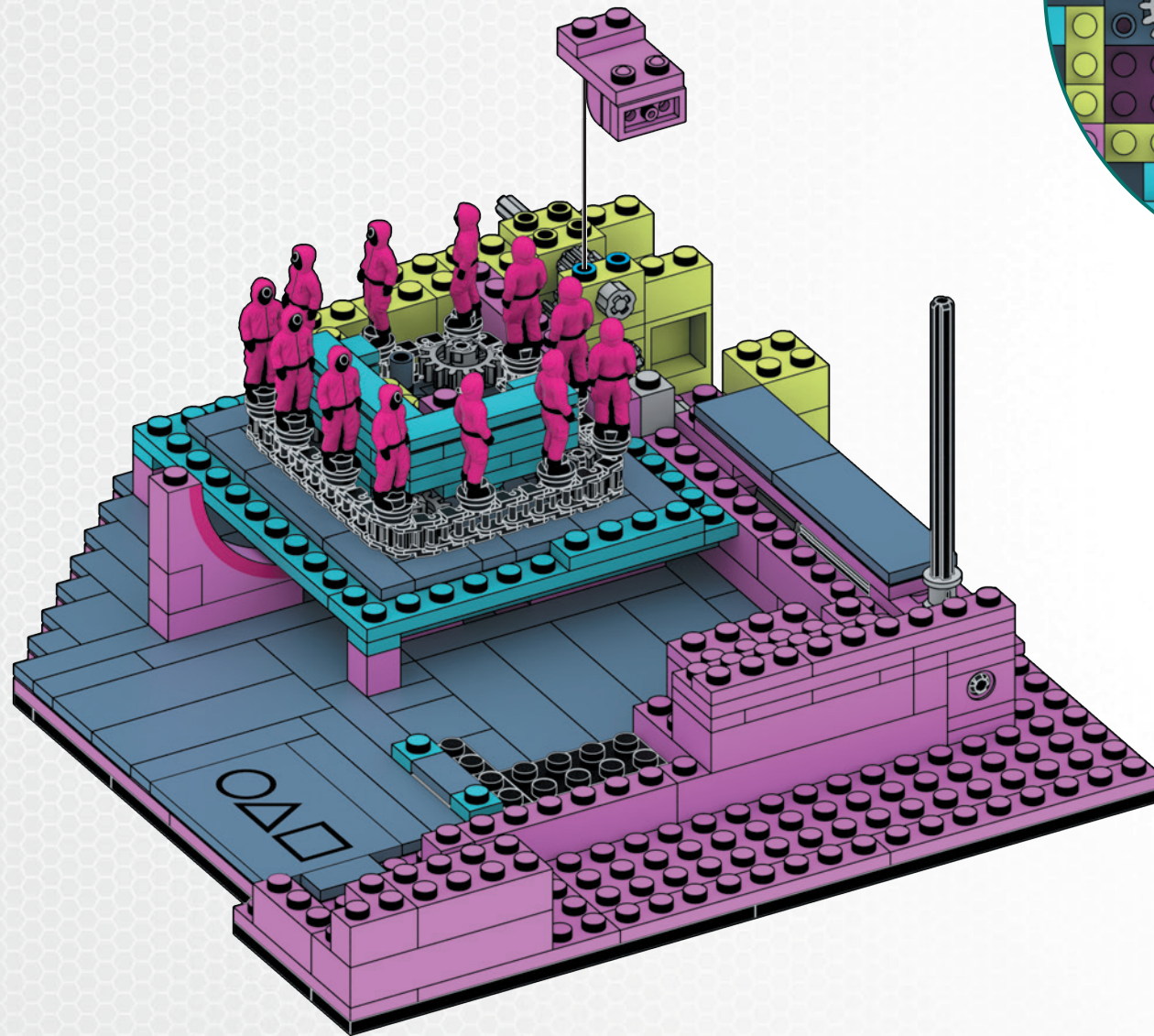

110

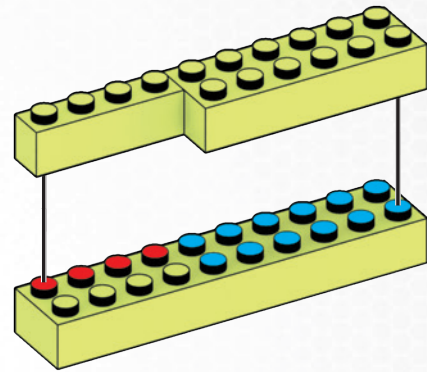
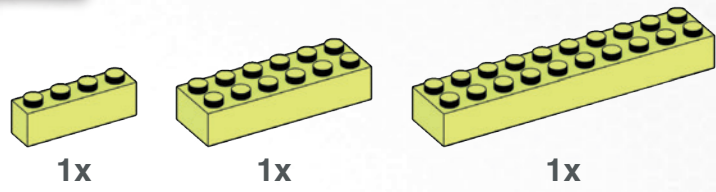

111

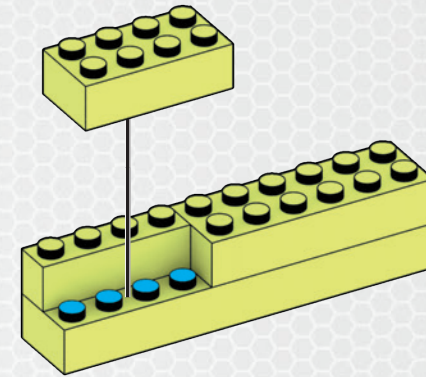
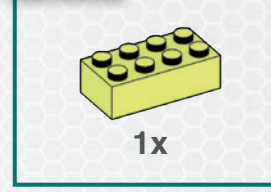

112

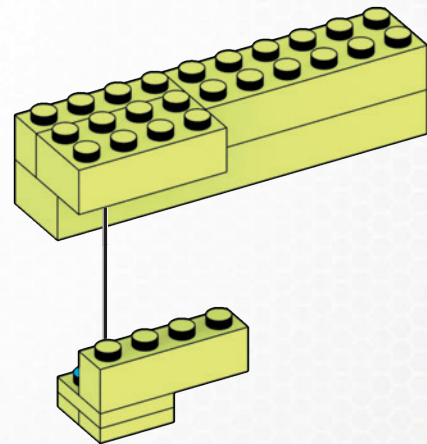
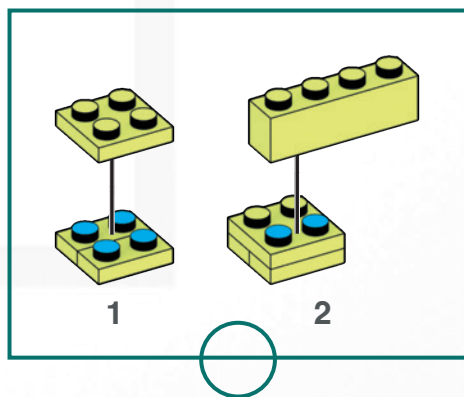

113

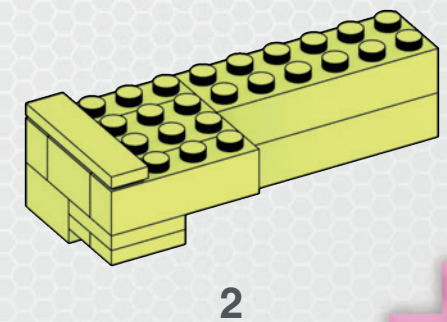
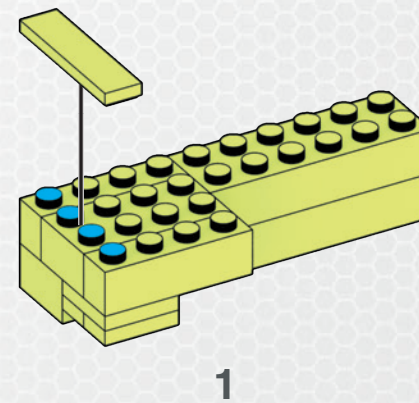
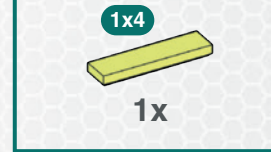

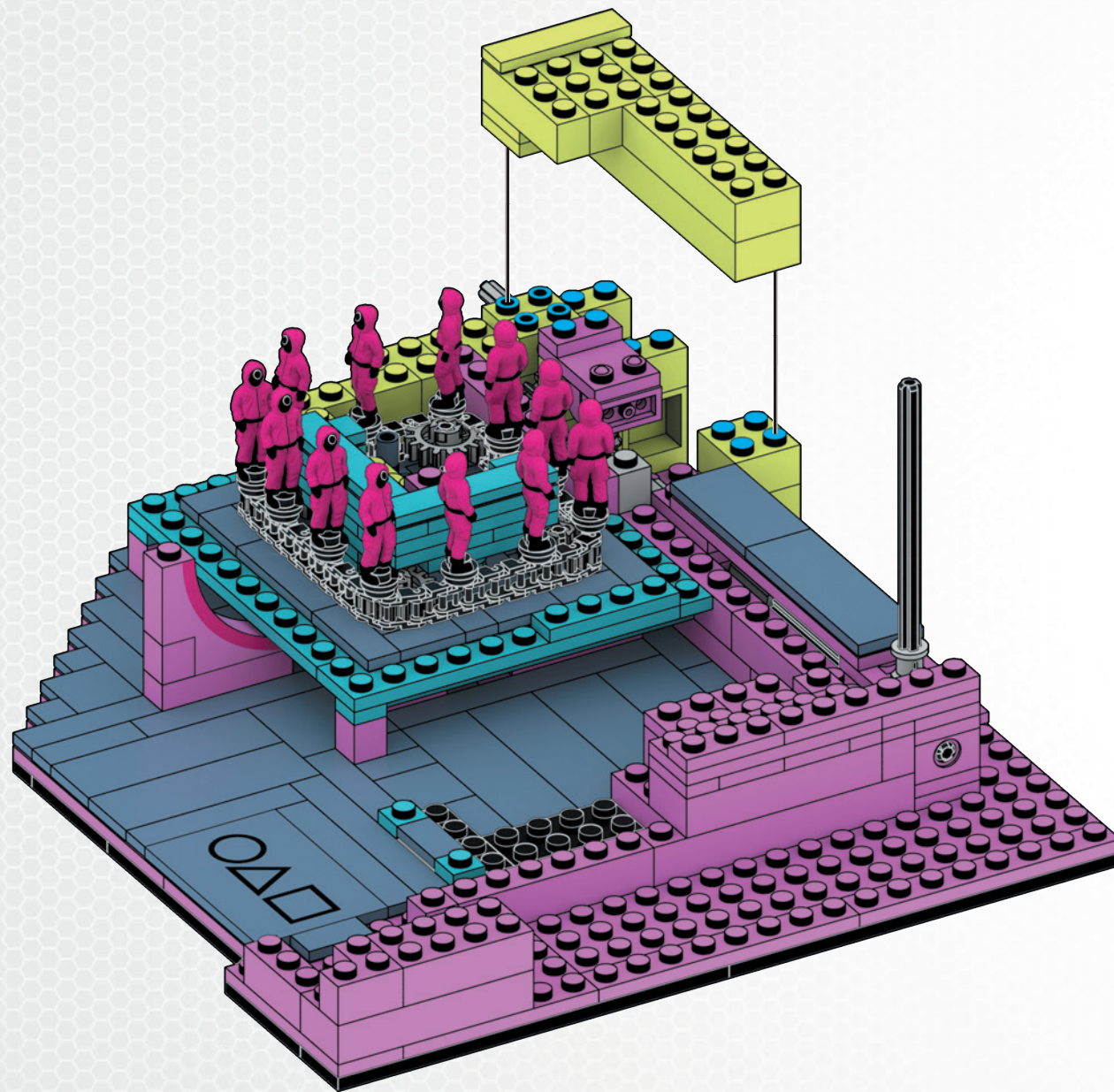

115

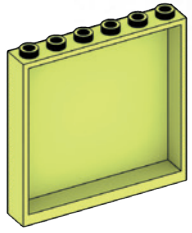

1x

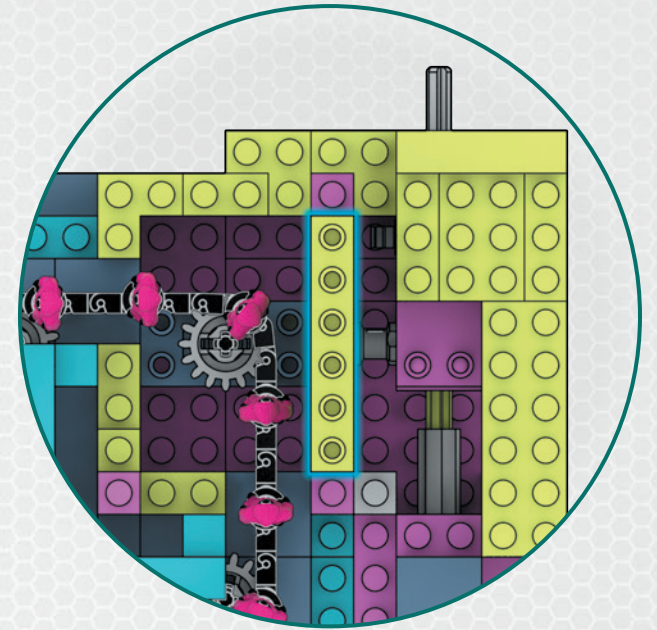
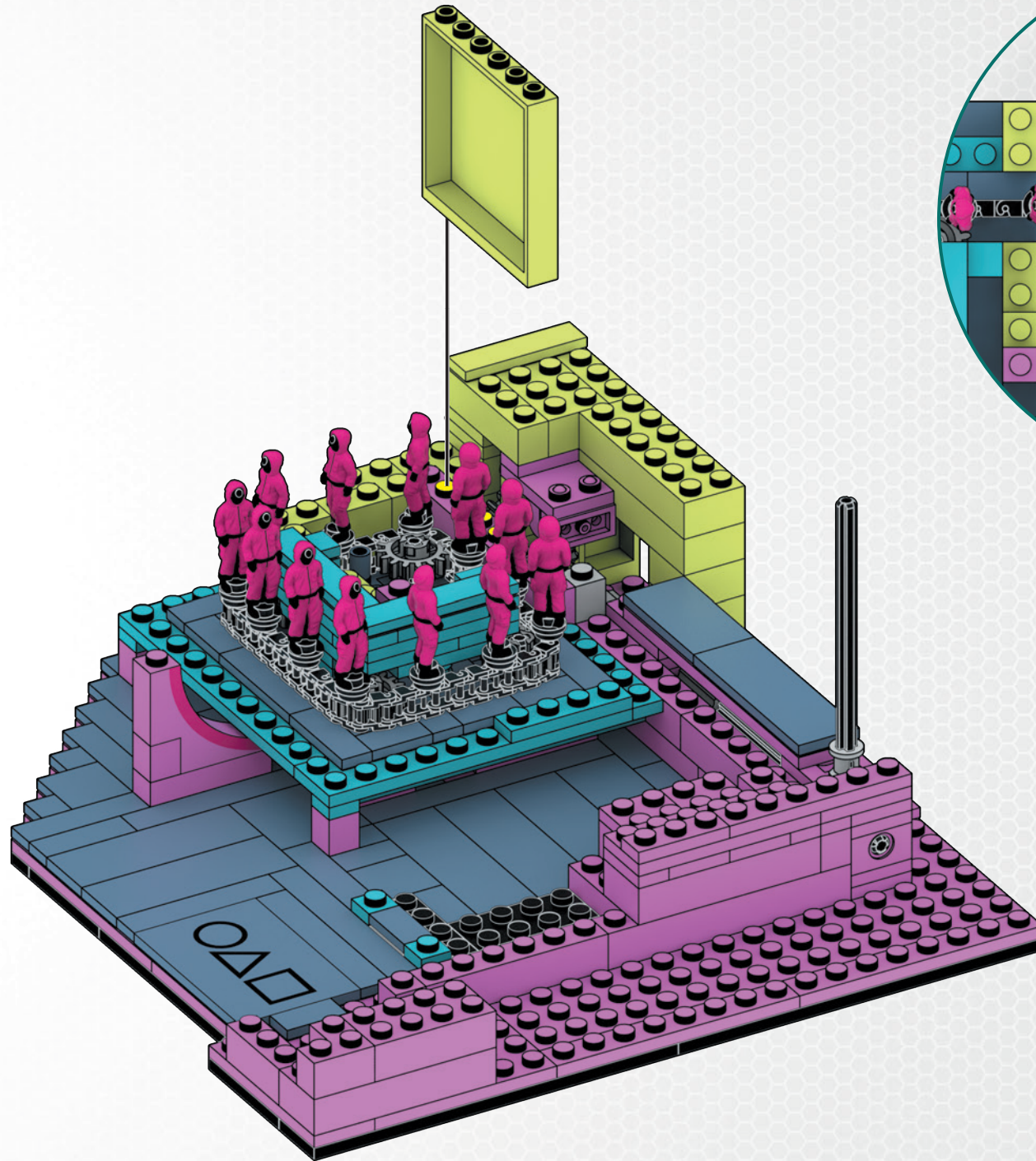

116

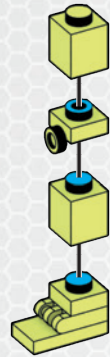
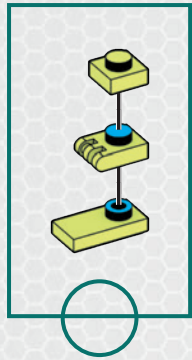
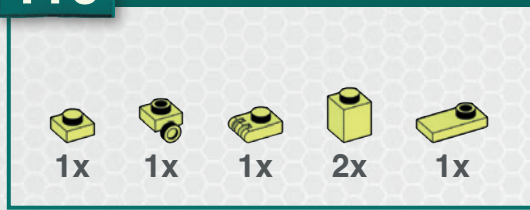

118

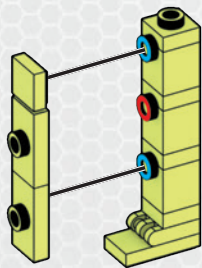

117

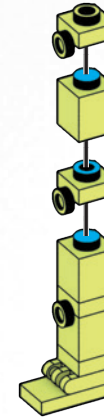
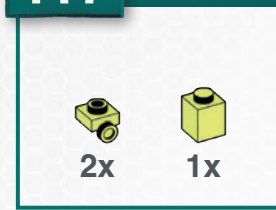

119

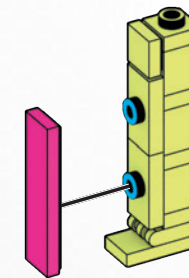
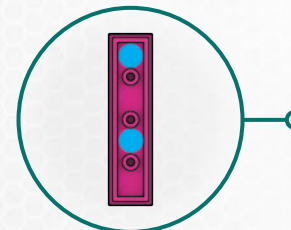
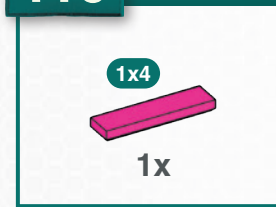

1



2

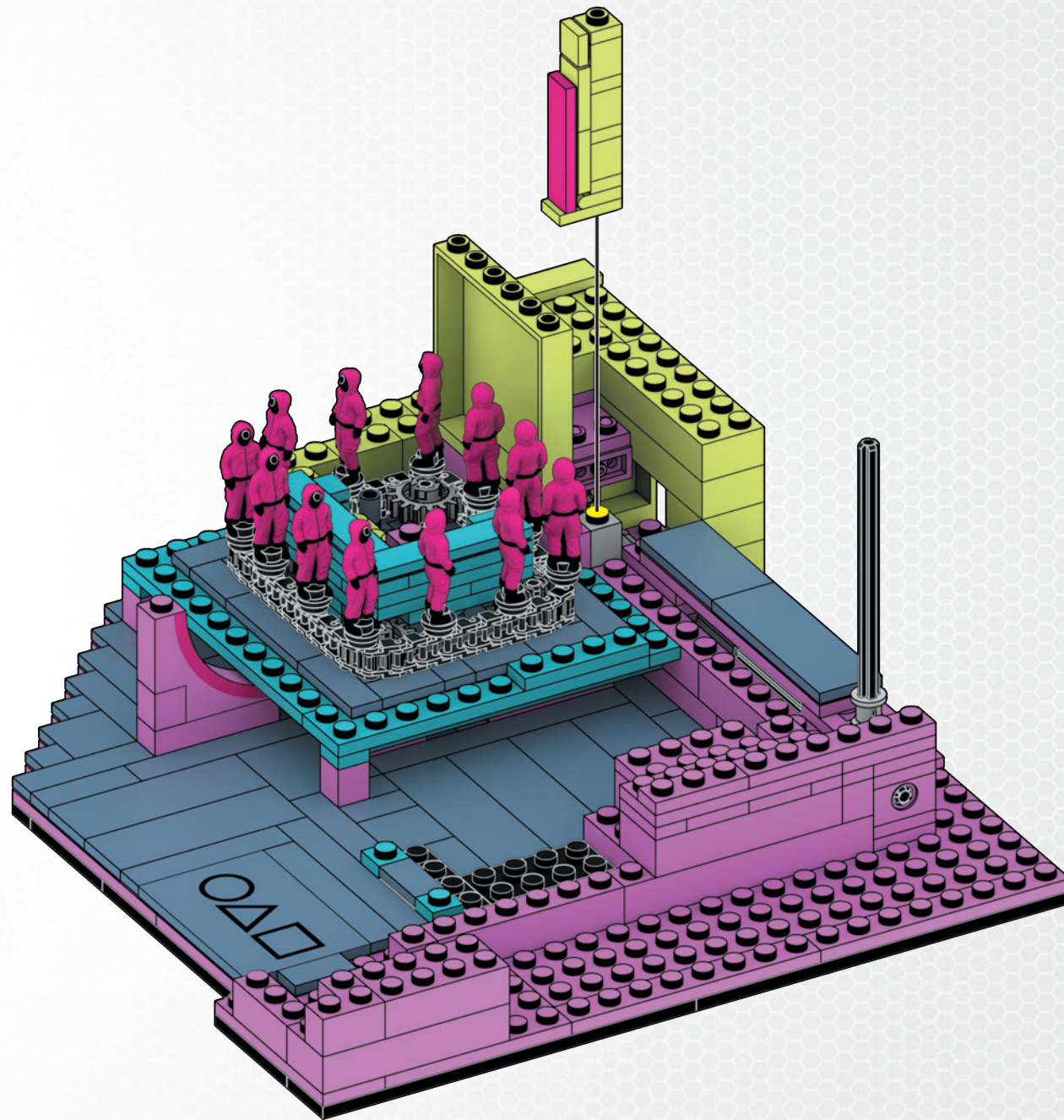

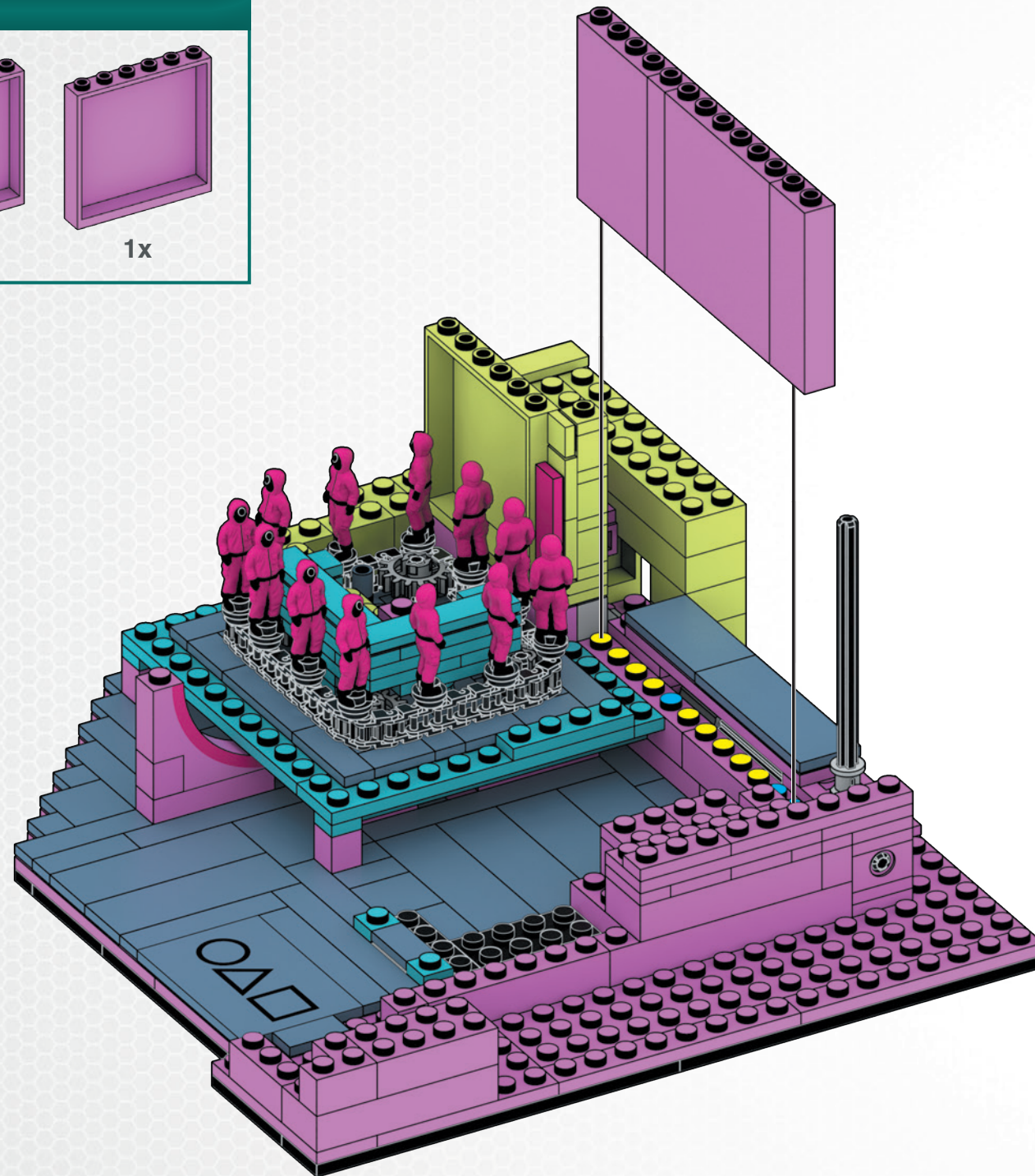
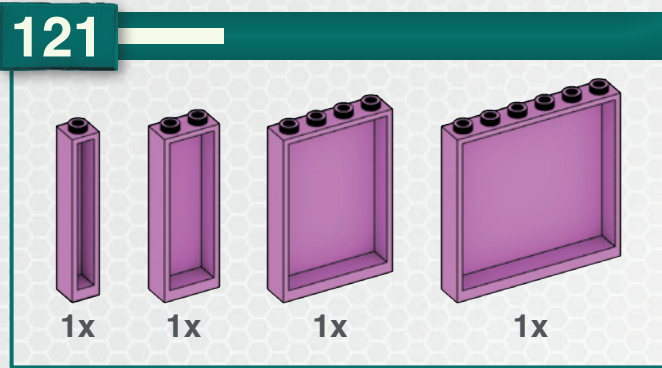

122

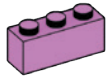

1x

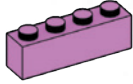

1x



2x

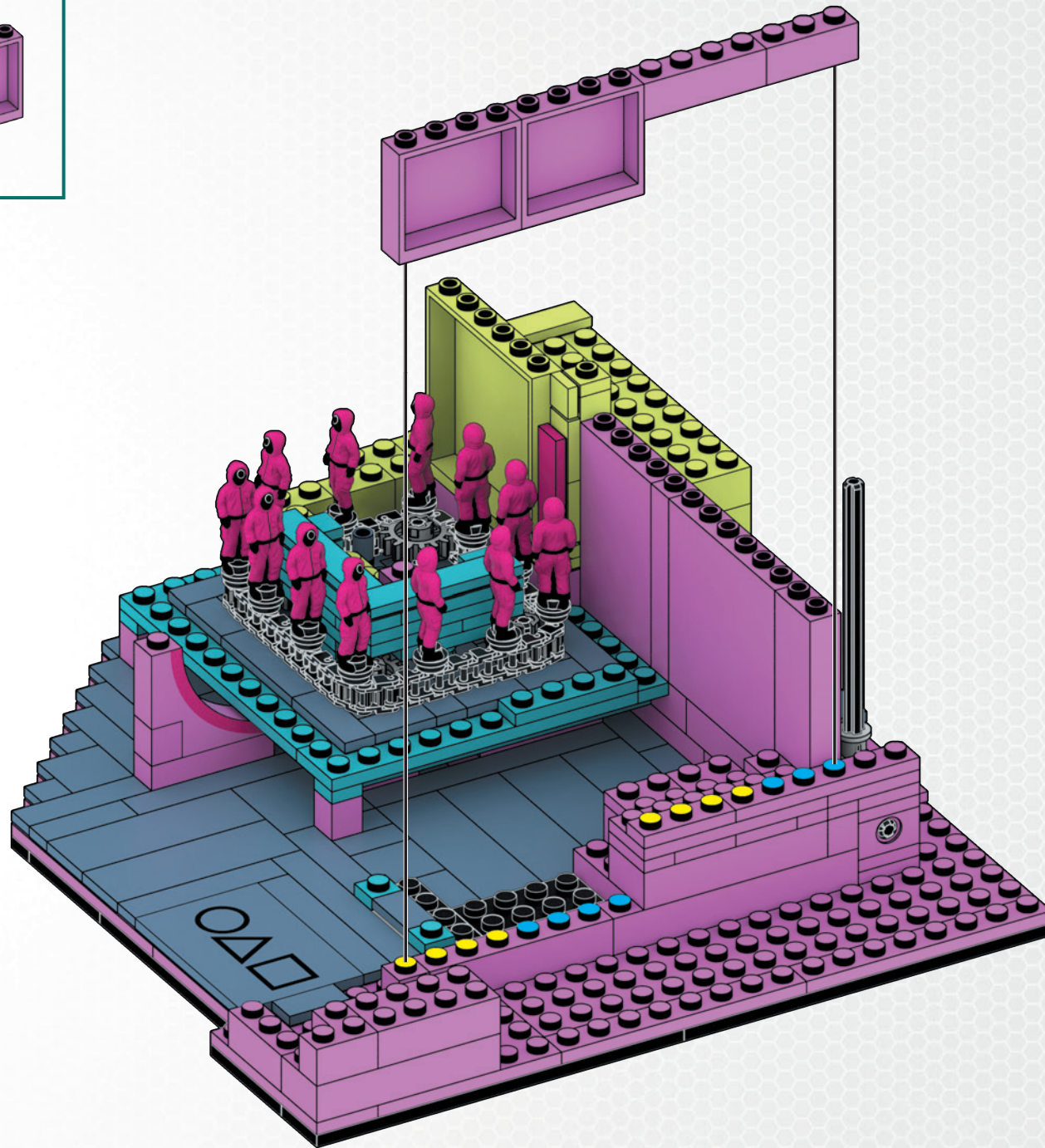

123

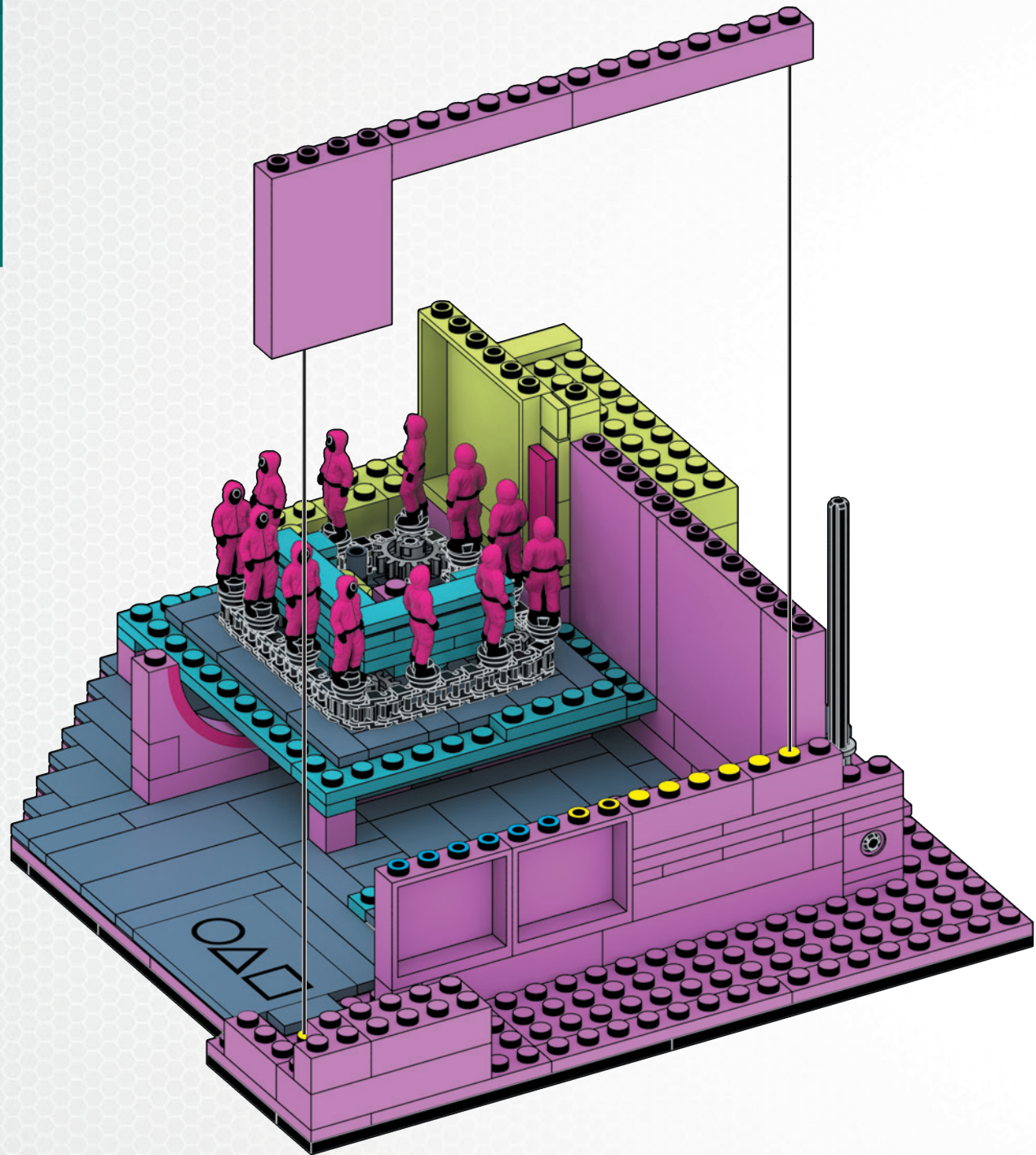
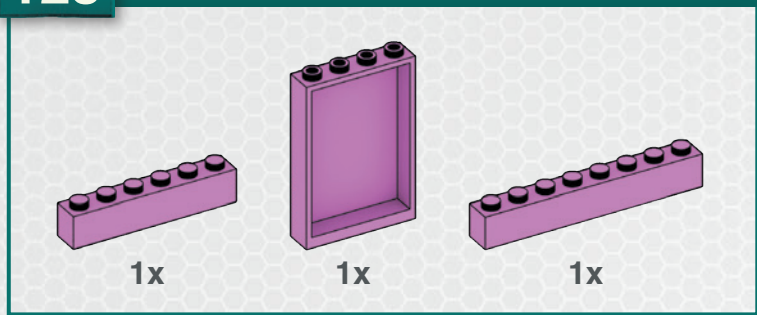

124



1x



1x



1x

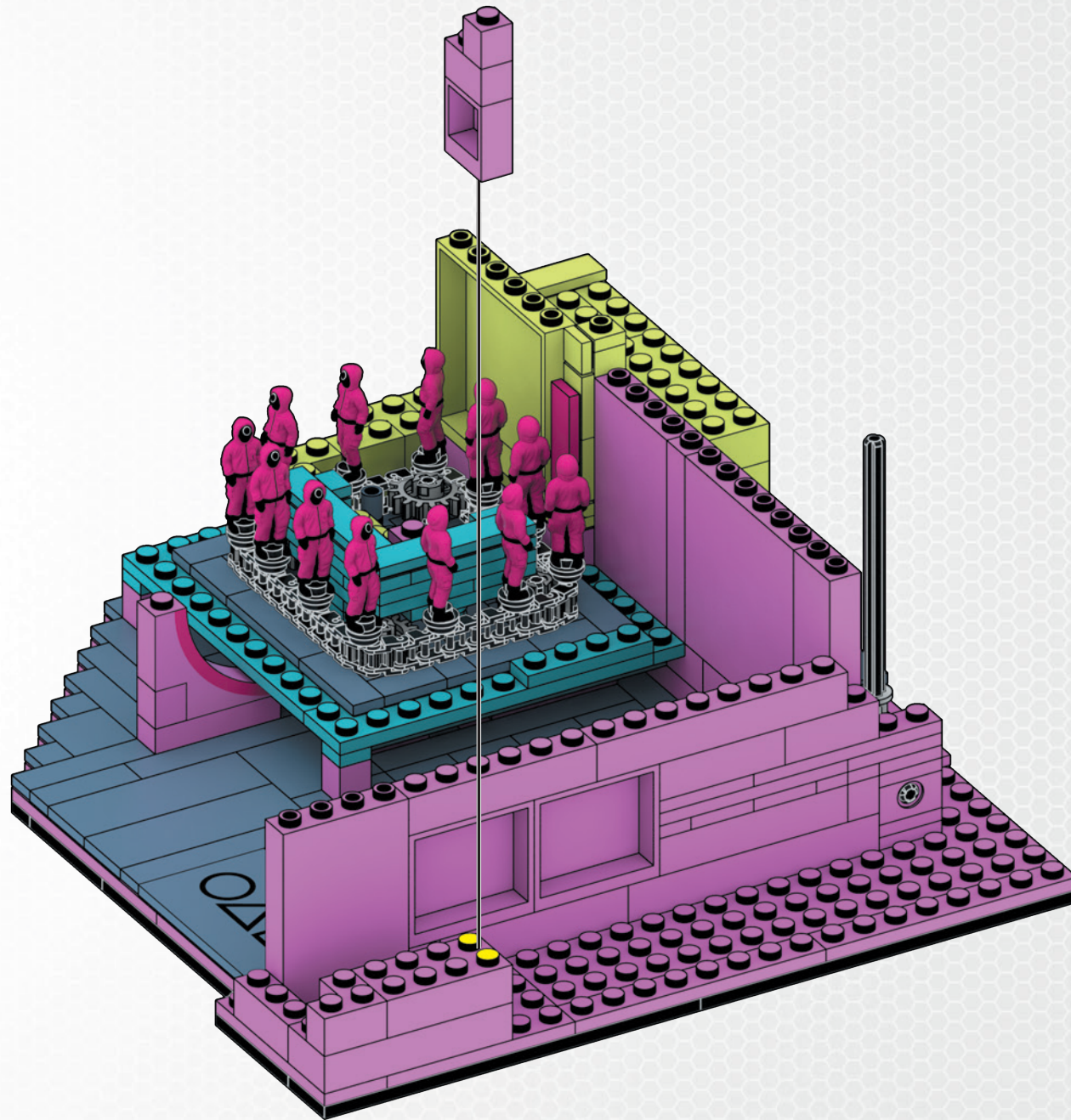
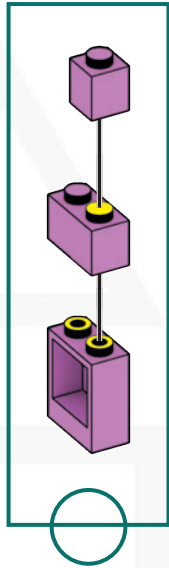

125

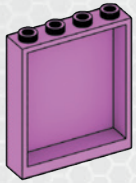

1x

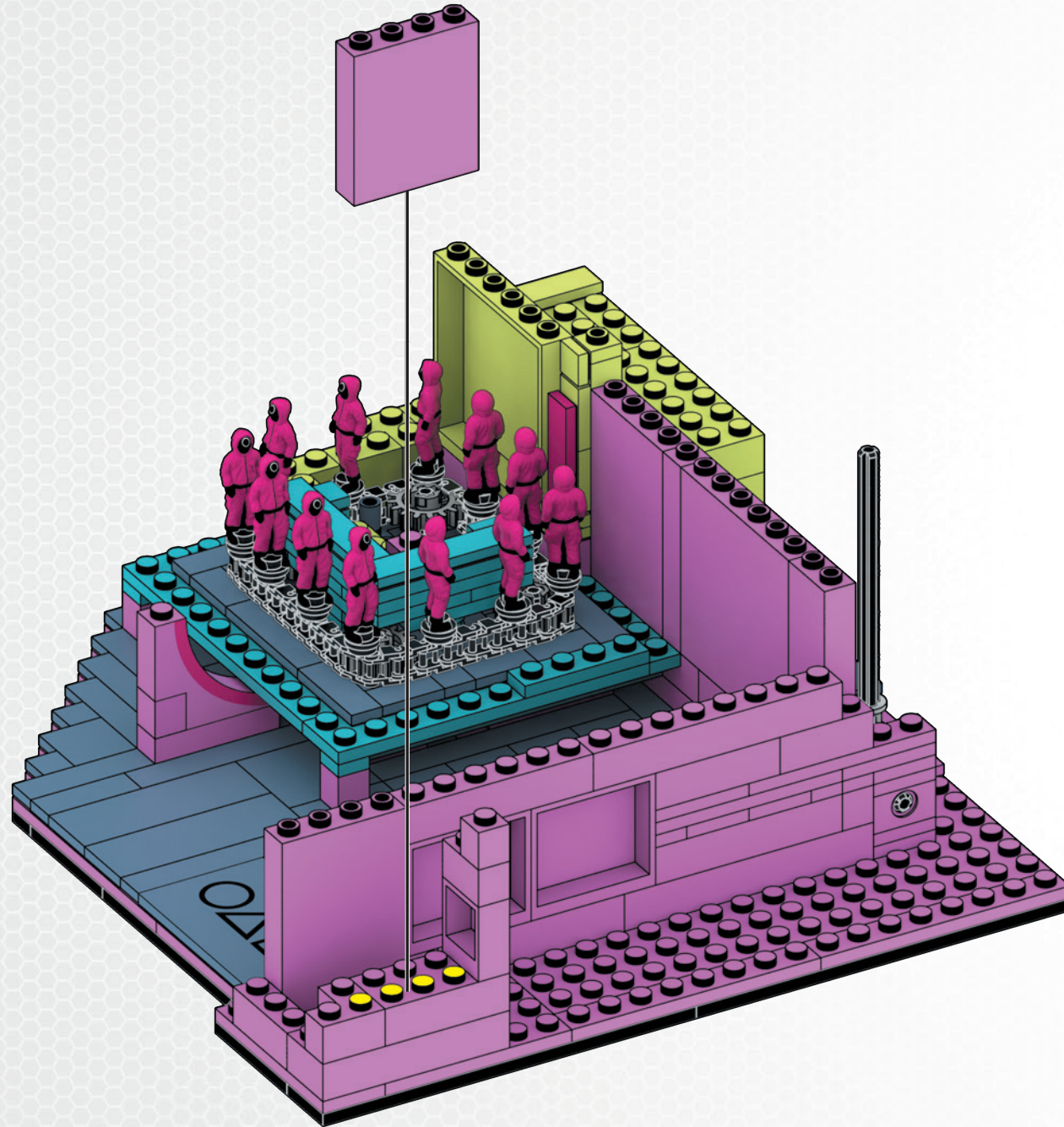

126

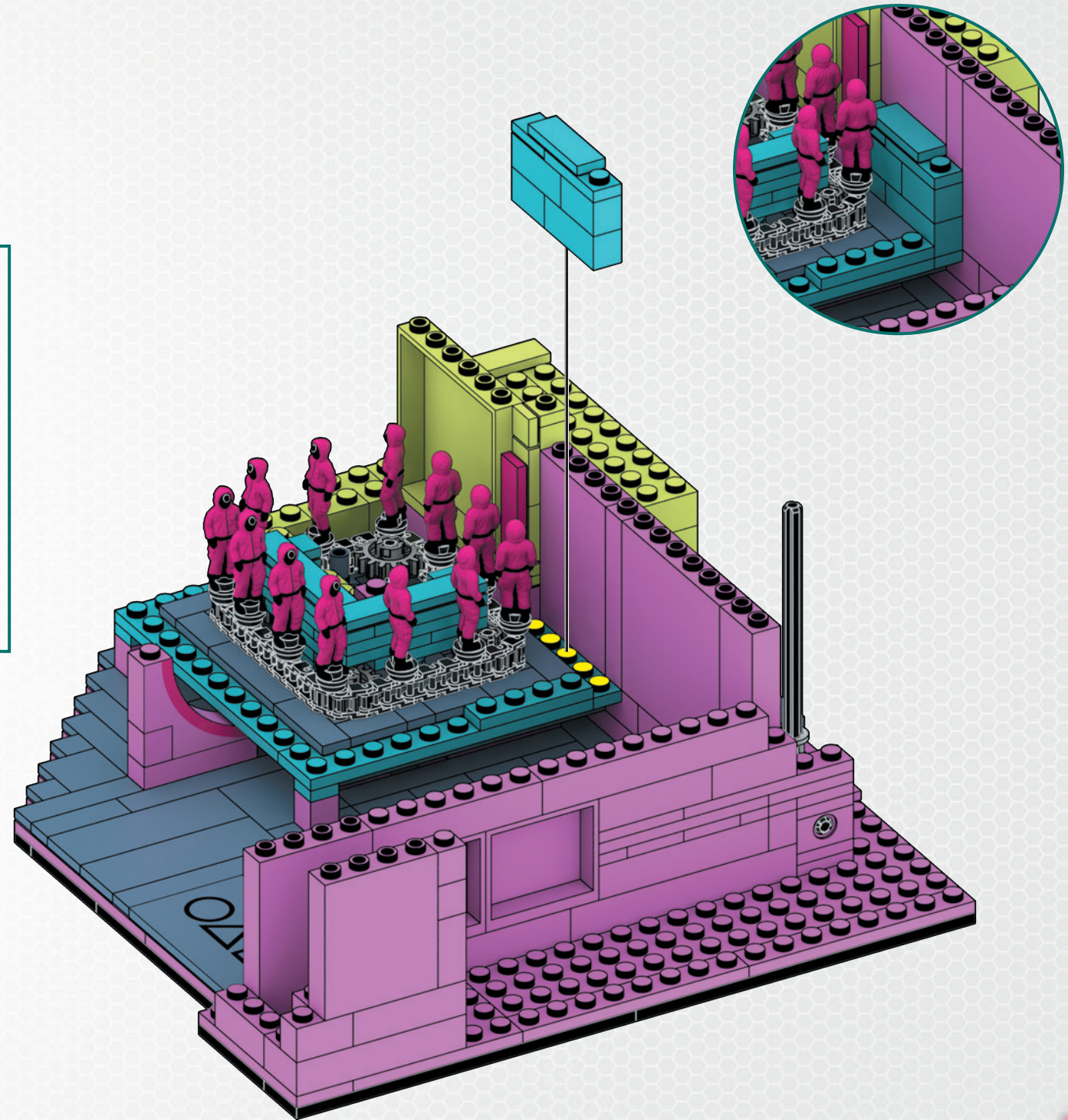
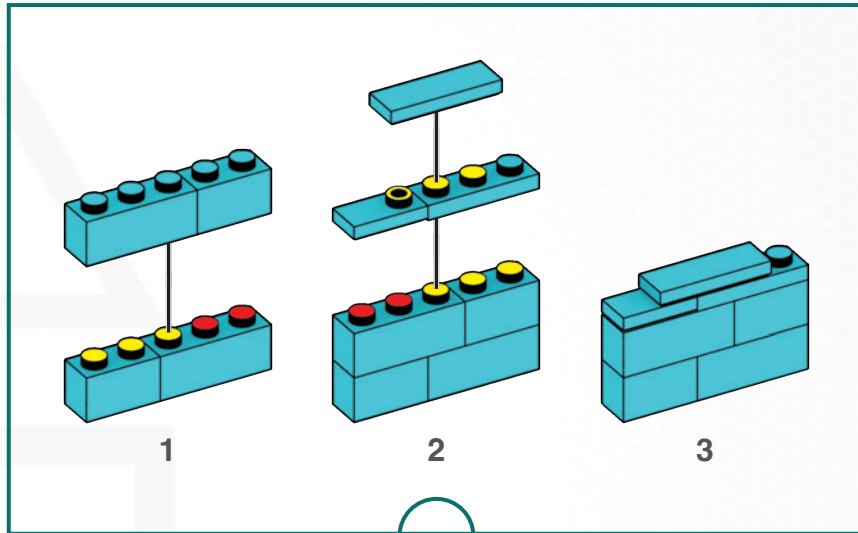
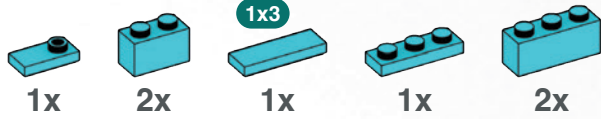

127

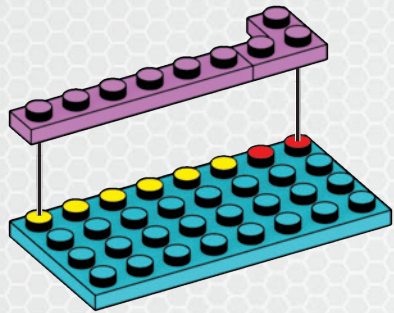
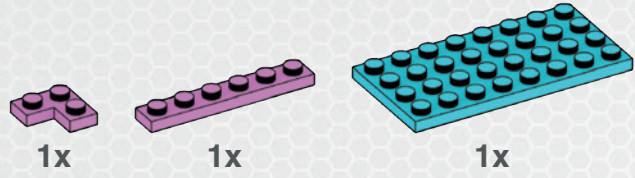

128

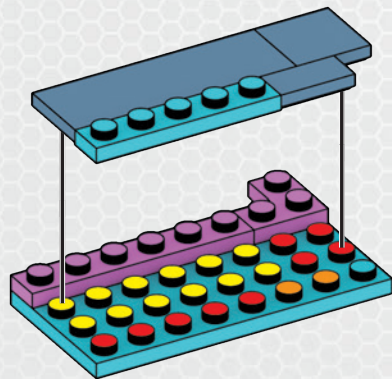
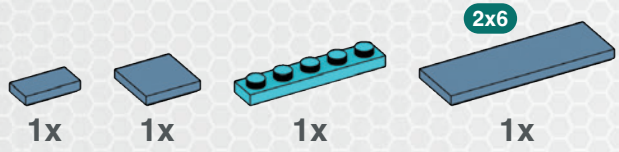

1

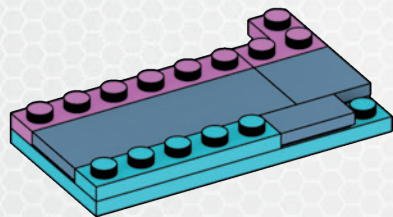

2

129

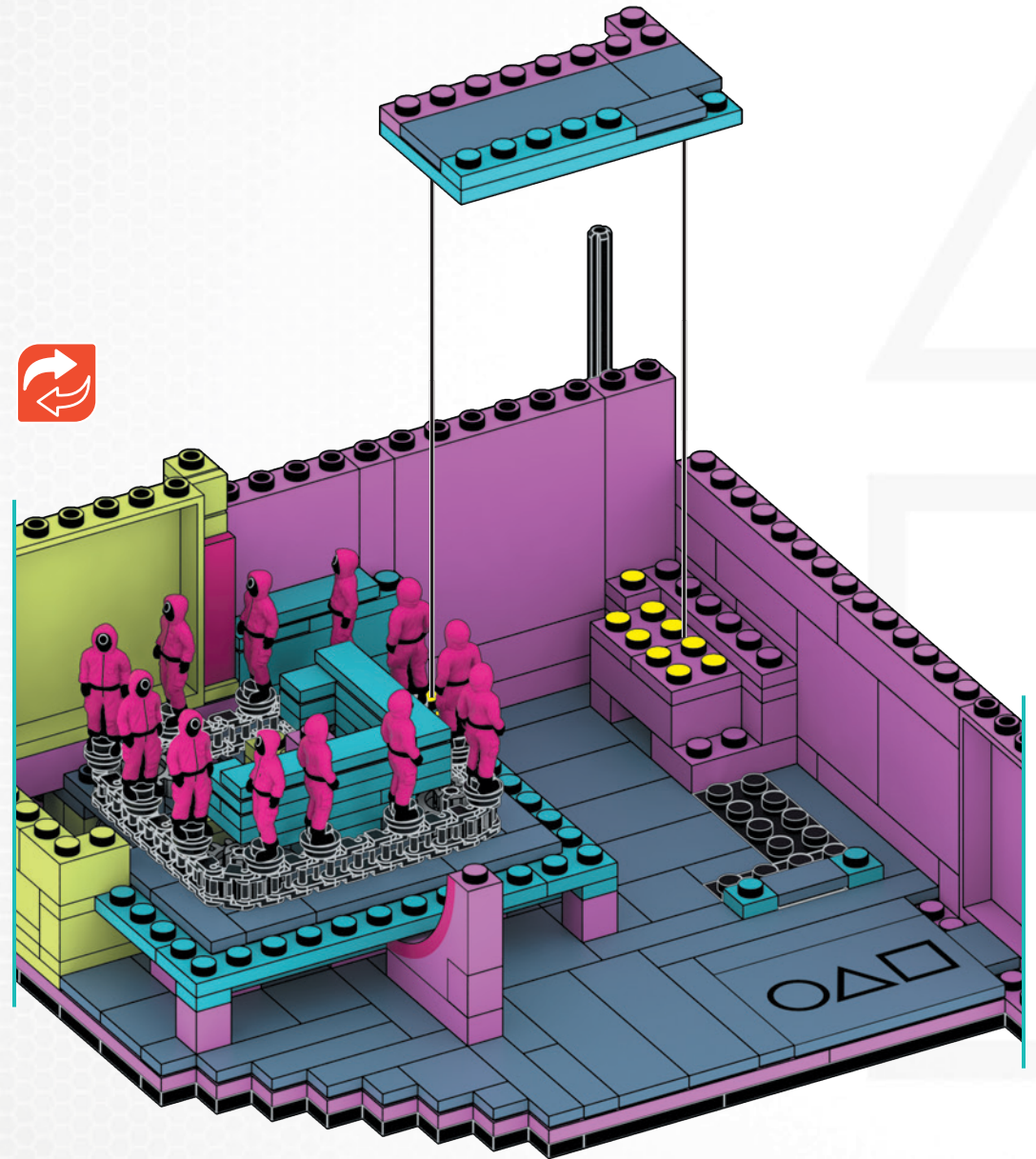

130

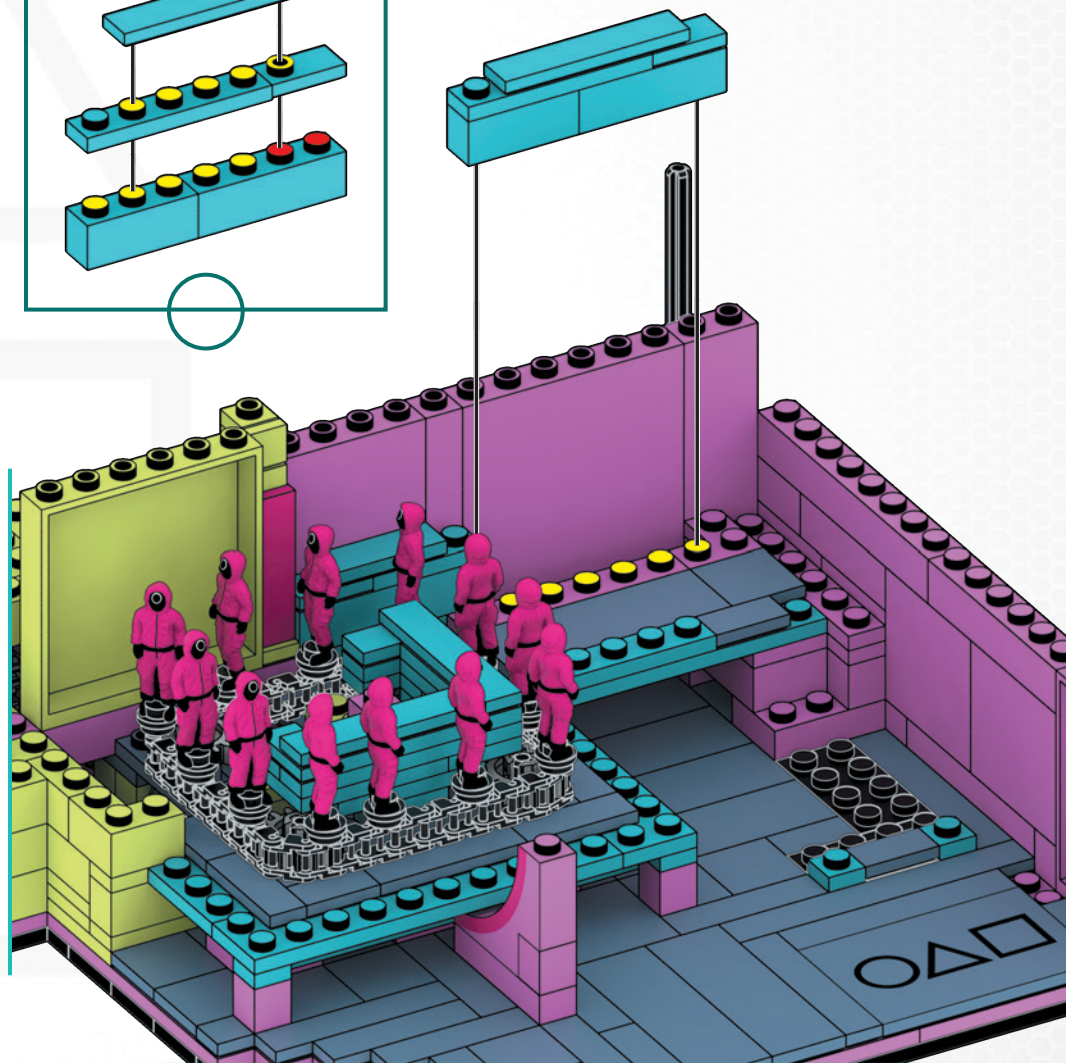
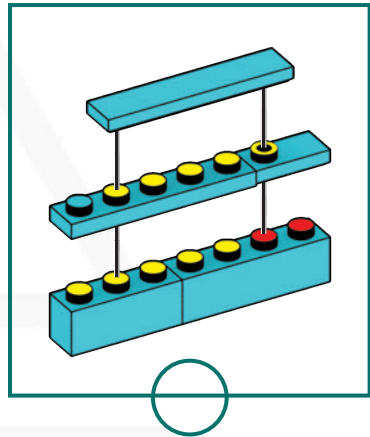
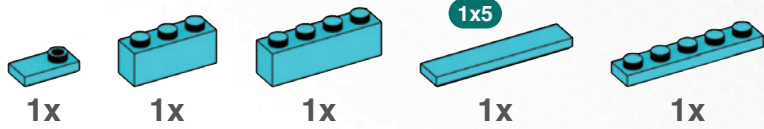

131

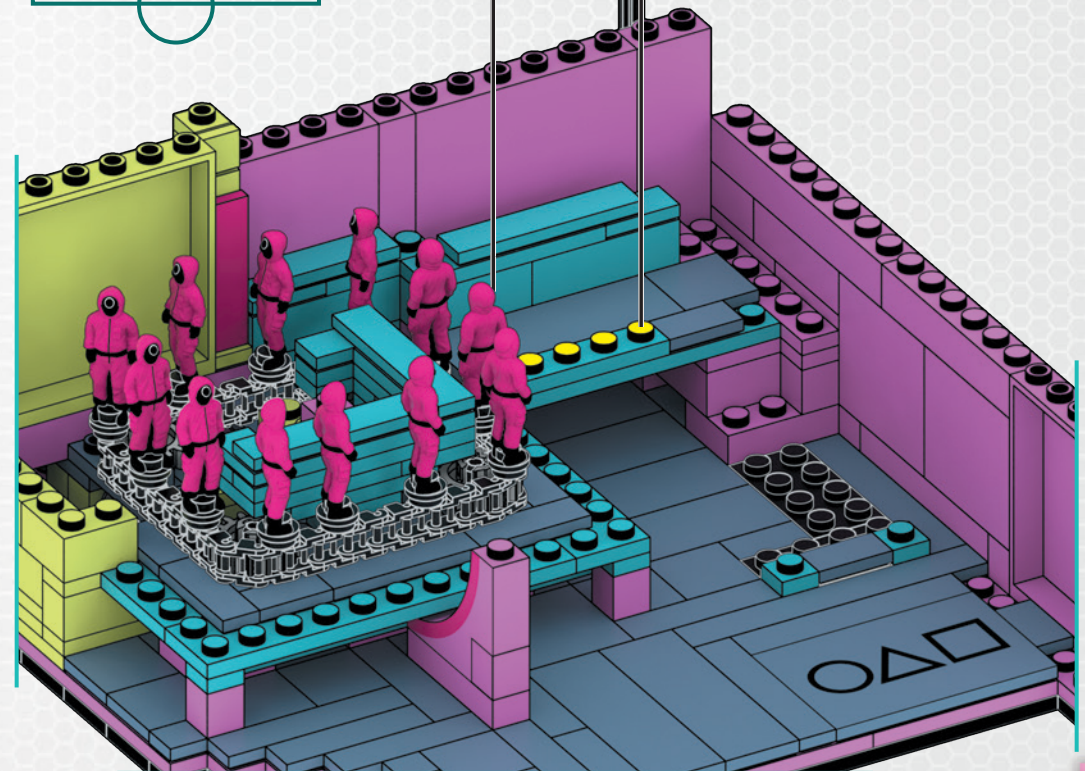
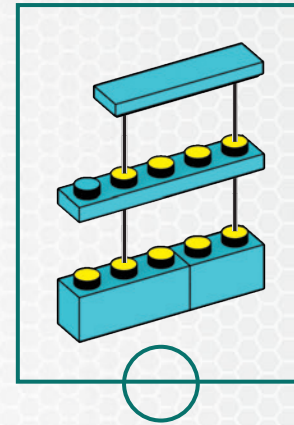
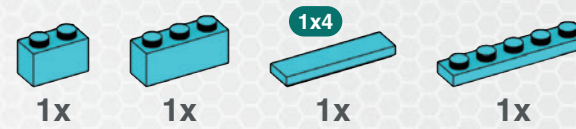

132

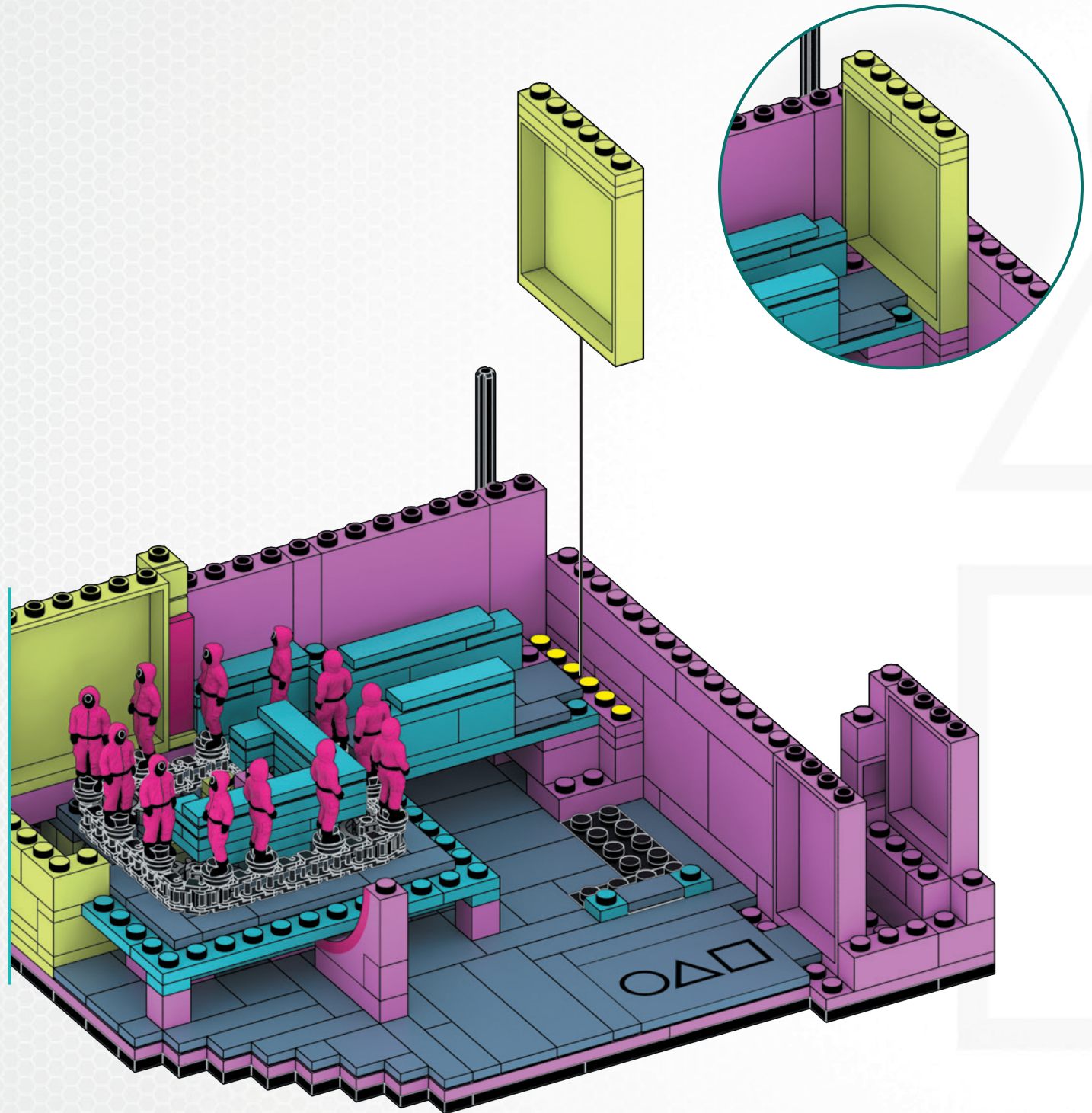
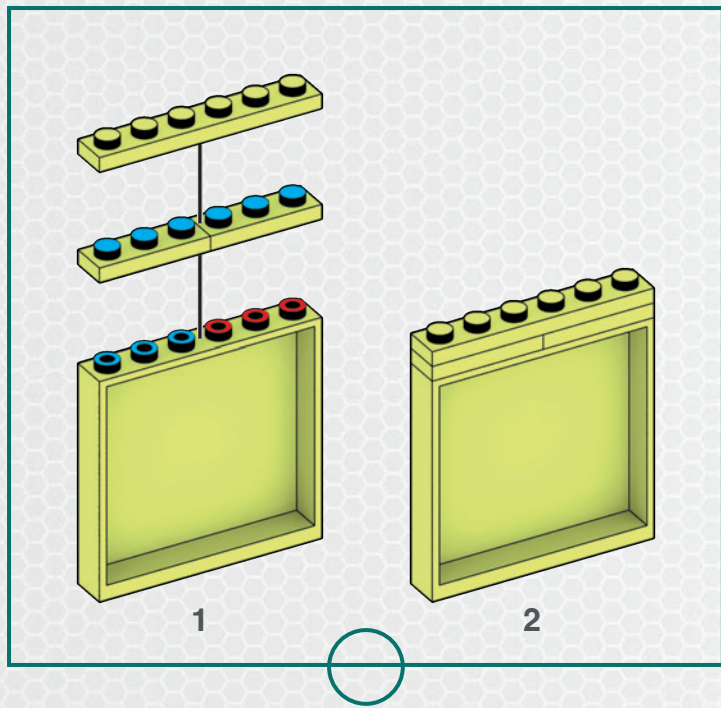
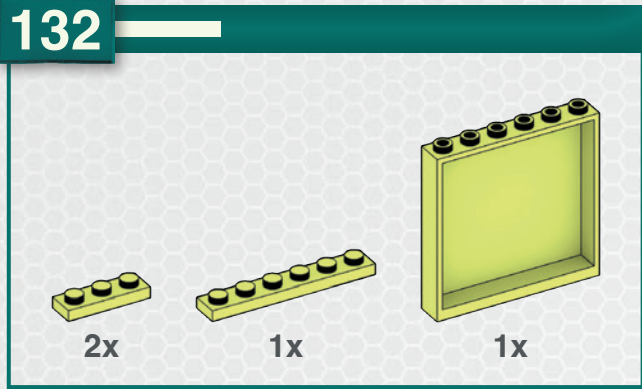

133



1x

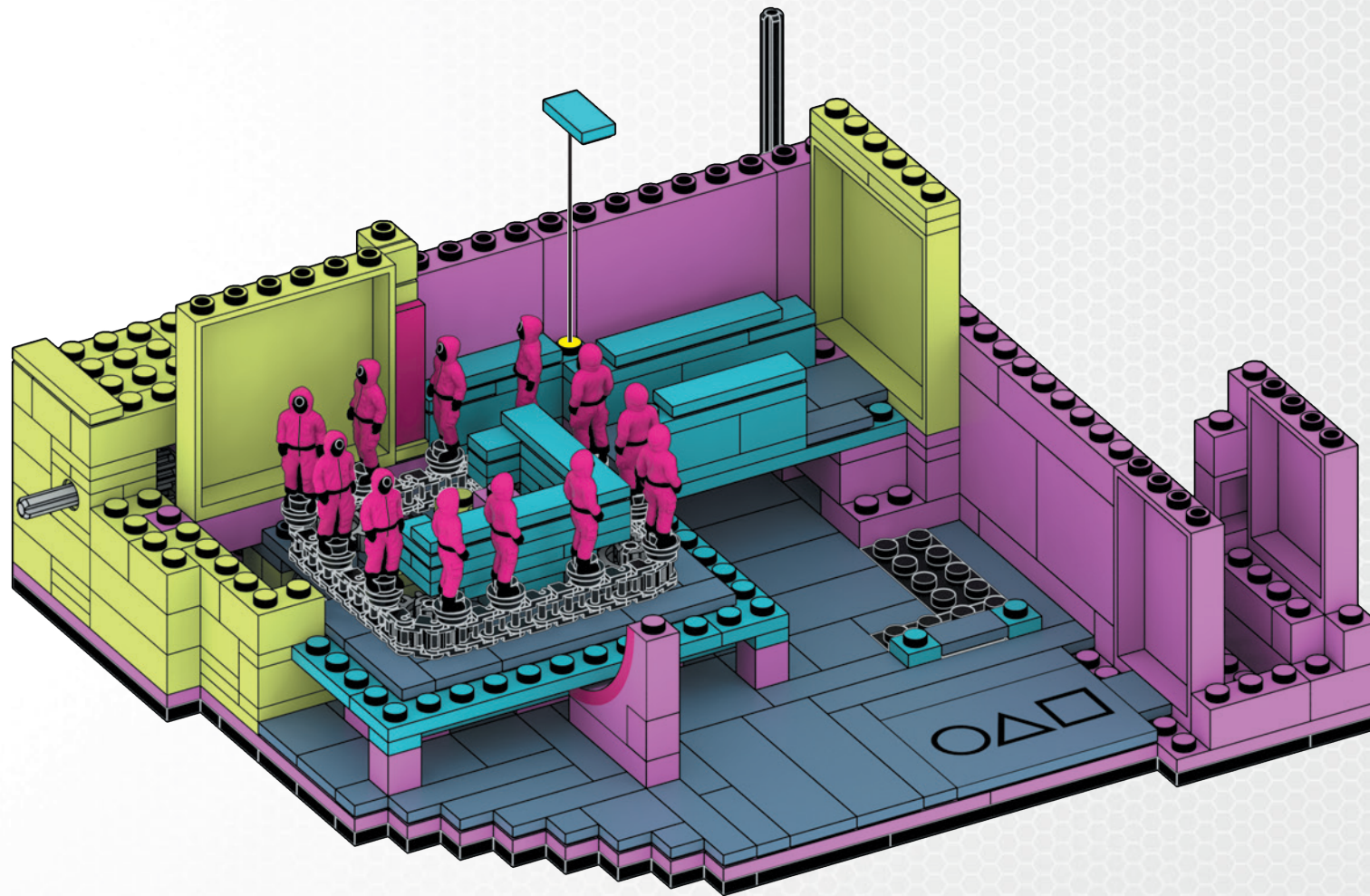
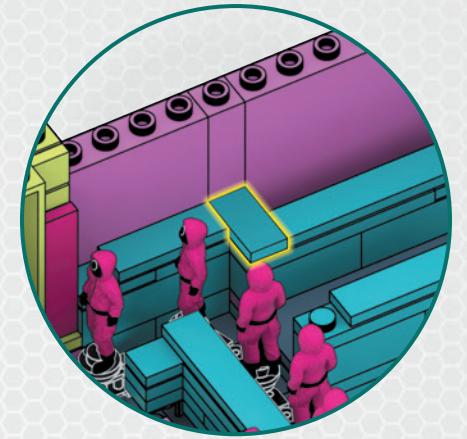



134

1x 2x

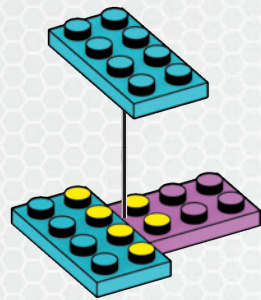

135

1x 2x 1x

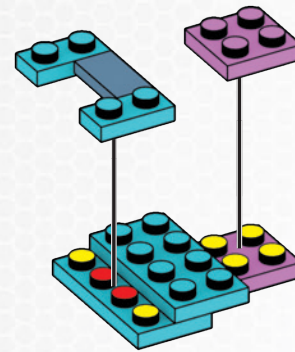

136

1x 2x 1x 1x

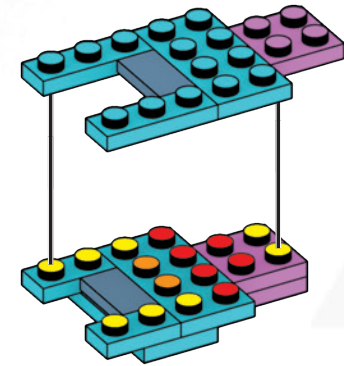

137

1x 1x 2x 1x

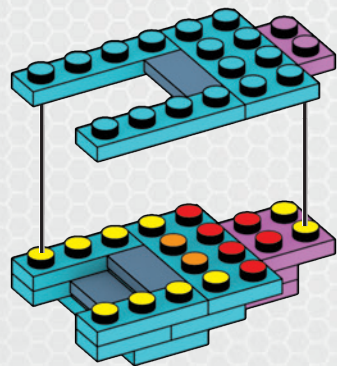

138

1x 2x 1x

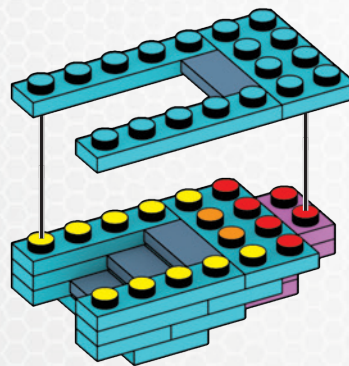

139

1x 2x 3x

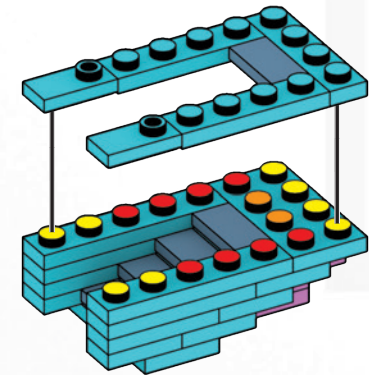

140

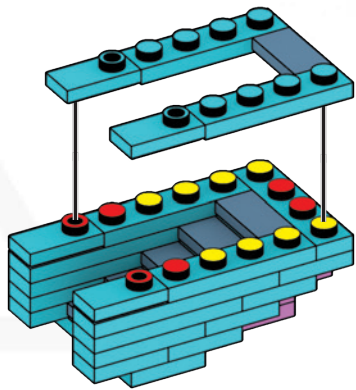
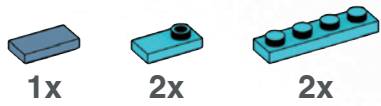

141

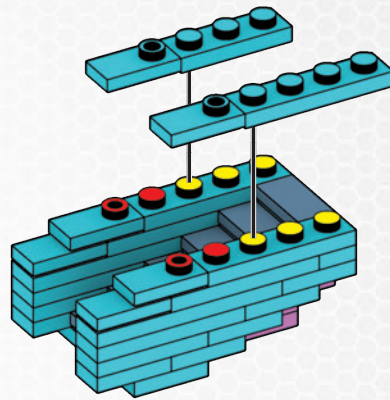
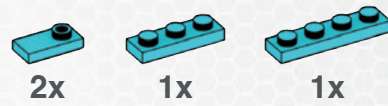

142

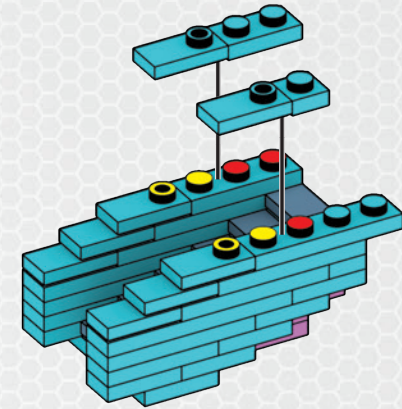

143

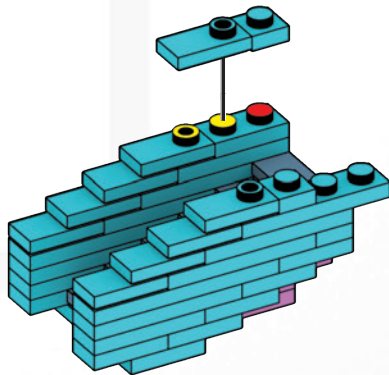

144

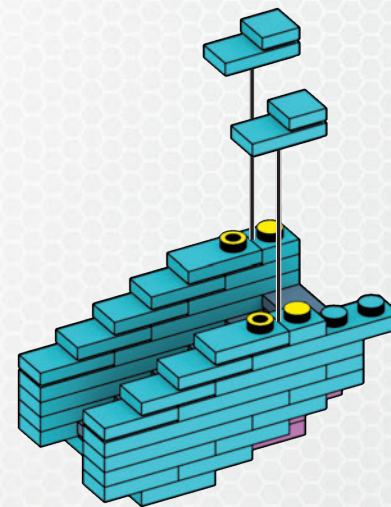
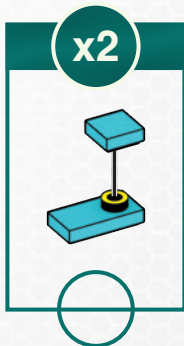

1

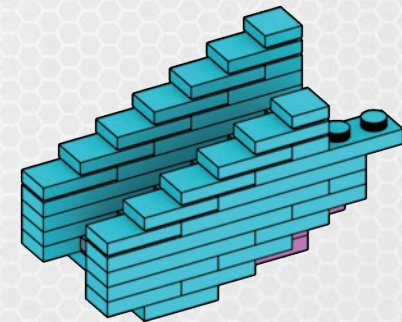

2

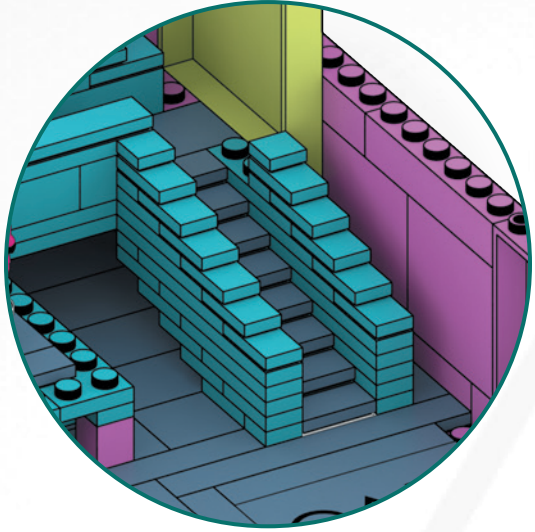
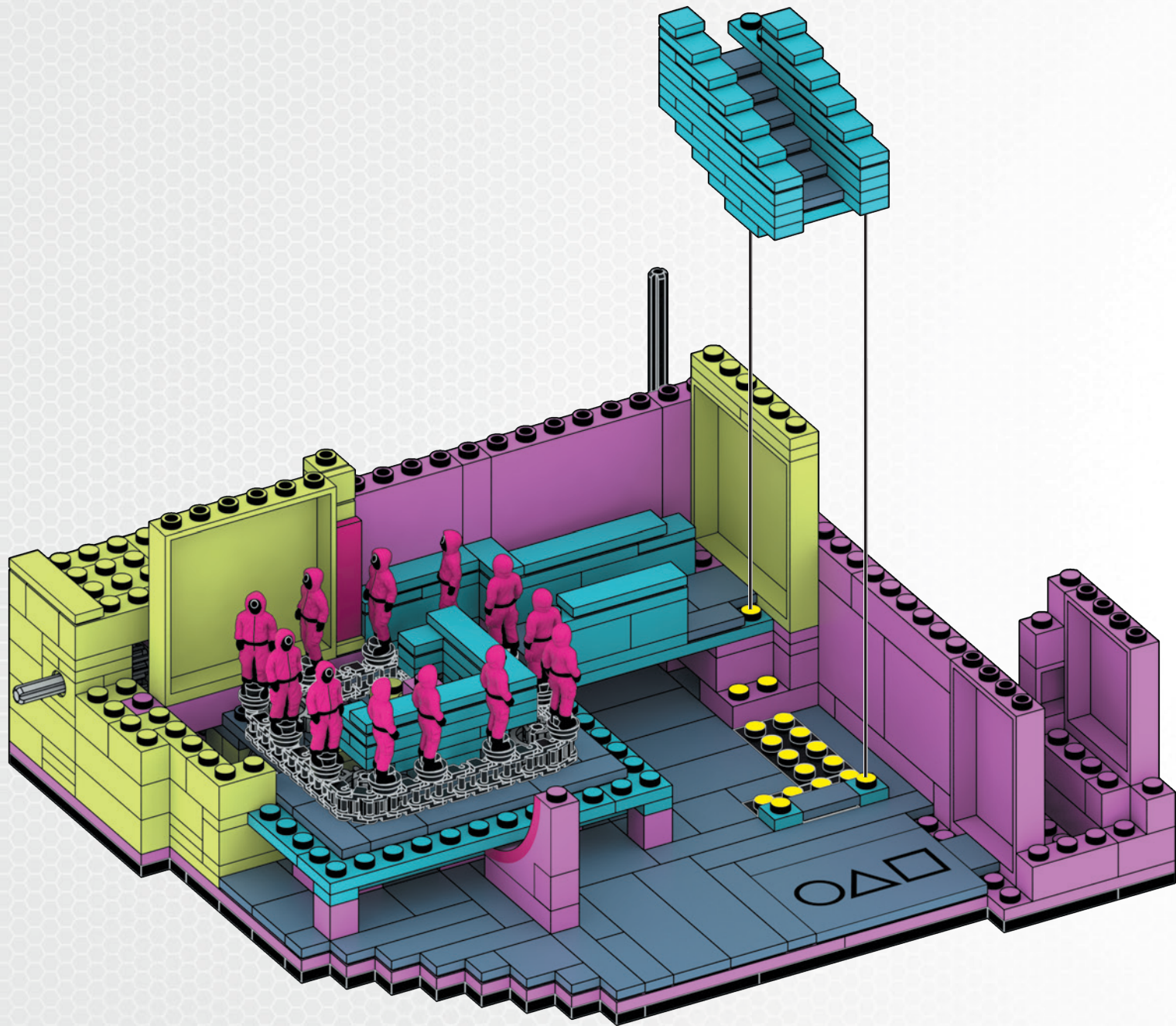

x2

146 149

146

1x 1x 1x 2x 1x

147

2x 1x

148

1x 2x

149

1x4
1x

1

2

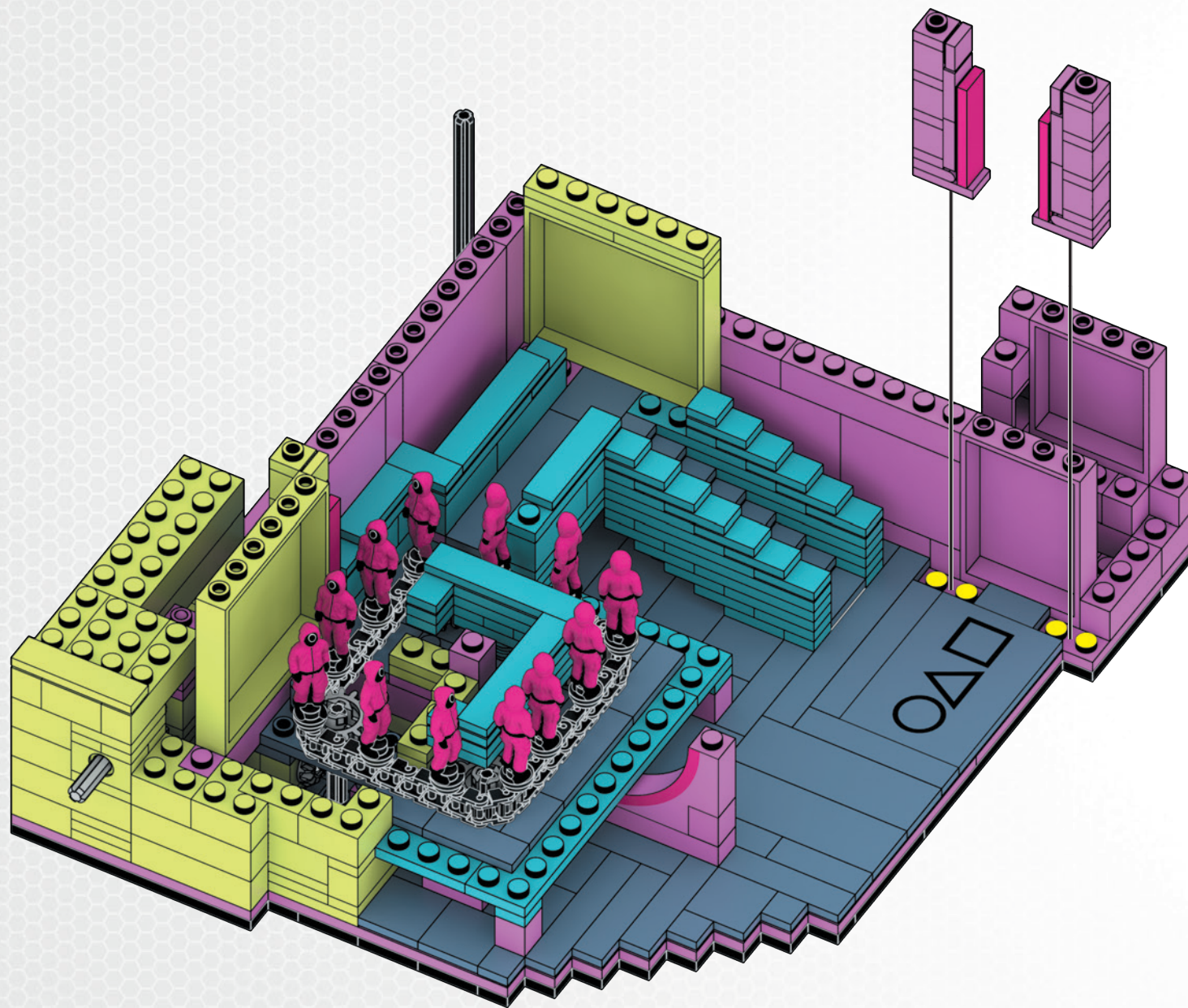

151



1x

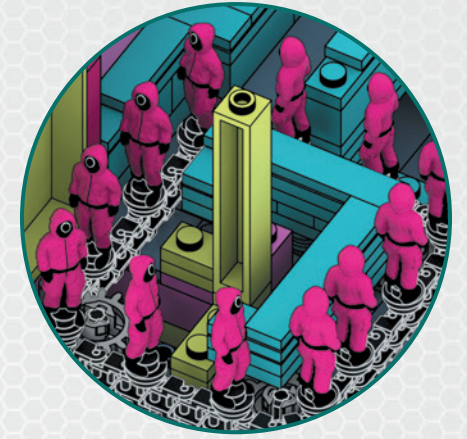
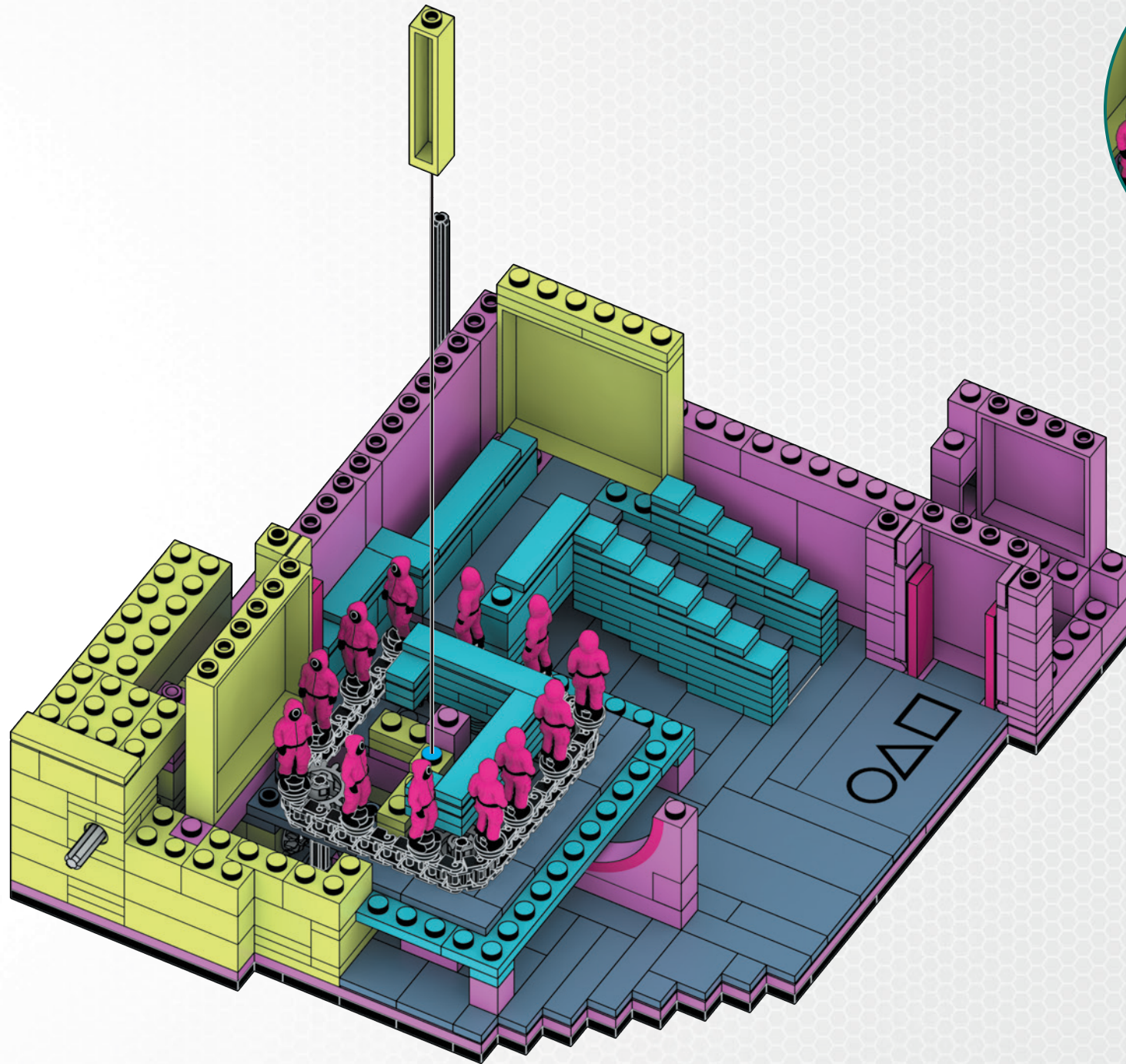

x5

152 155

152

1x 1x 1x 2x 1x

153

2x 1x

154

1x 2x

155

1x4
1x

1 2

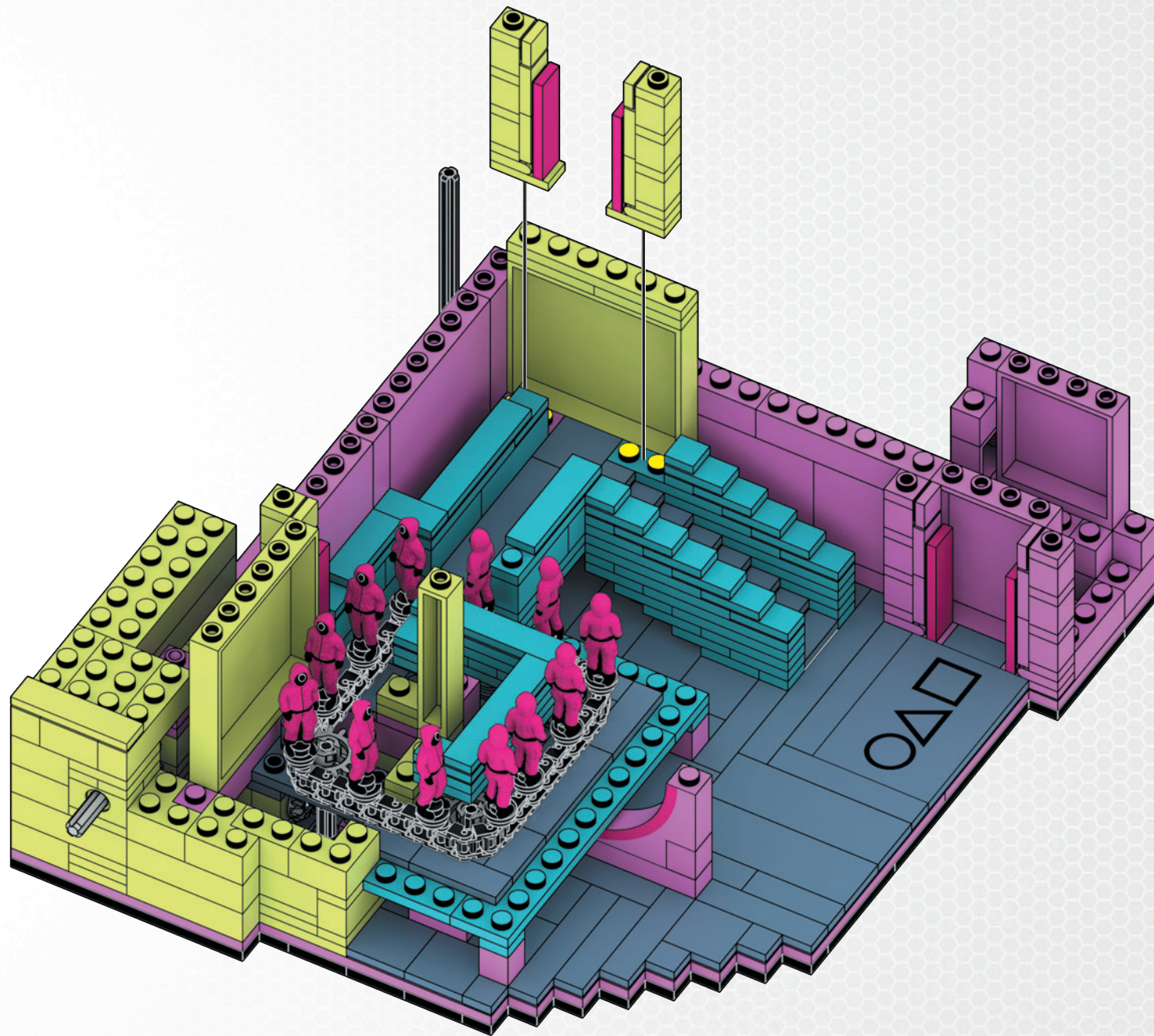

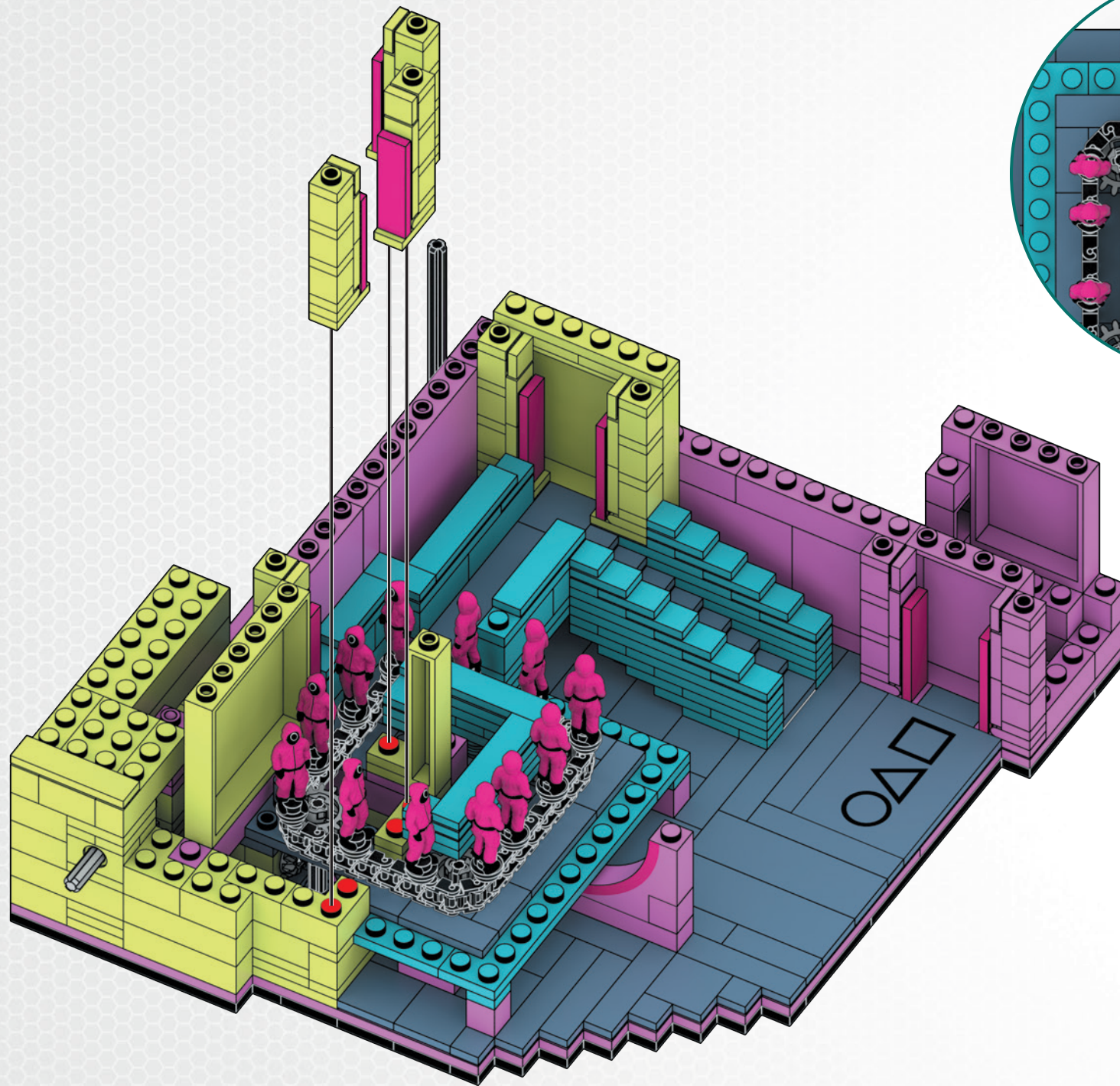

158

- 6x
- 3x
- 3x
- 3x
- 3x

x3

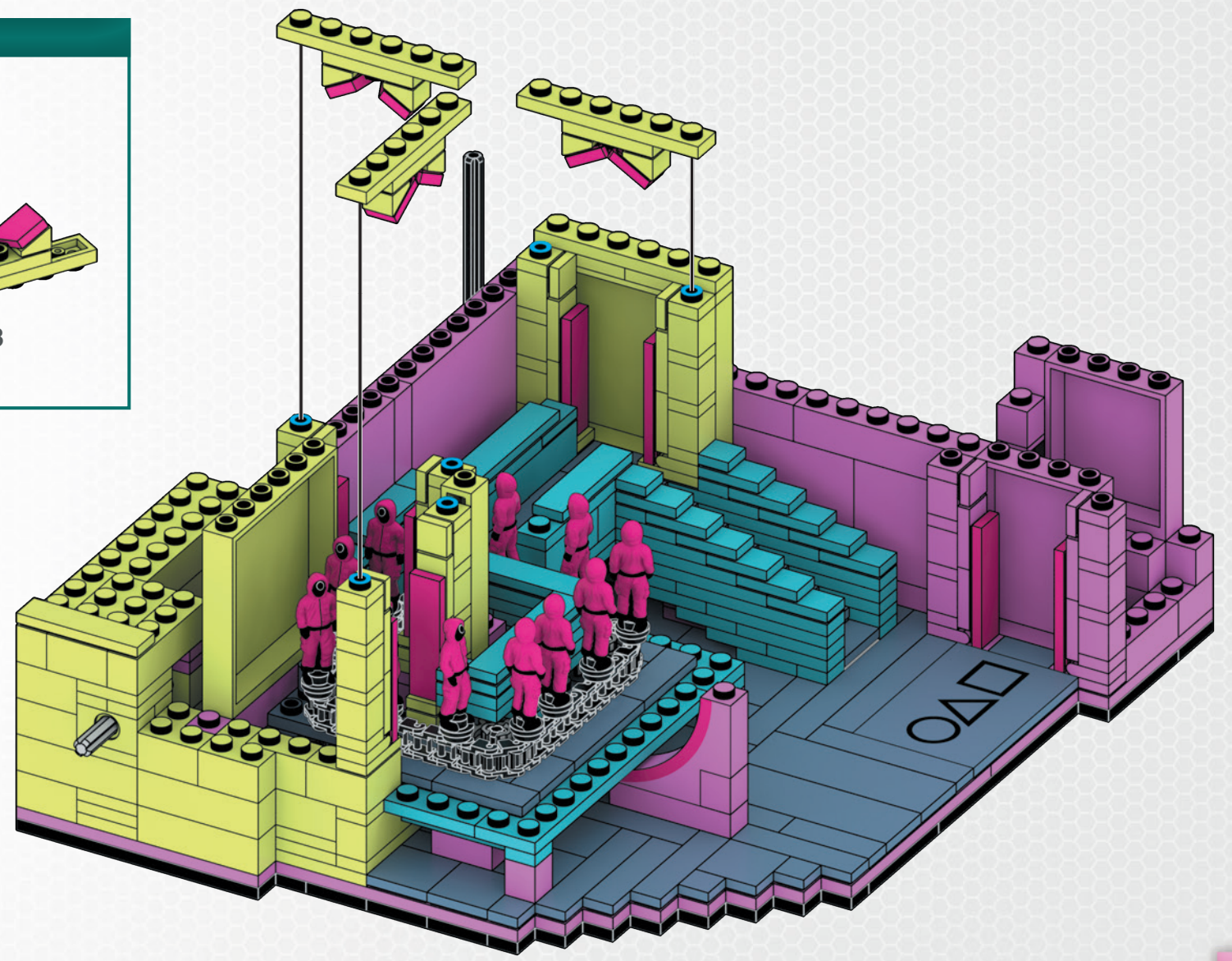
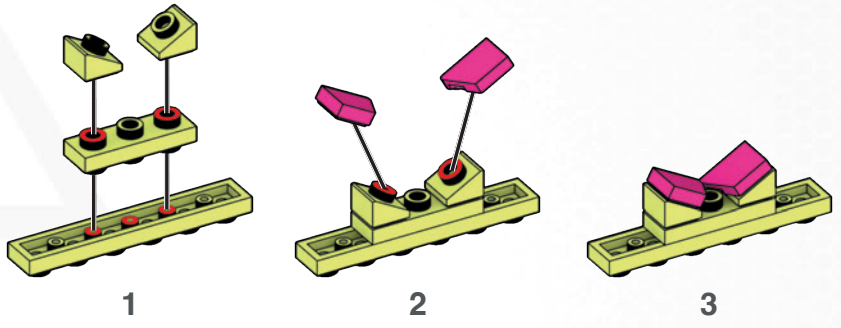

159

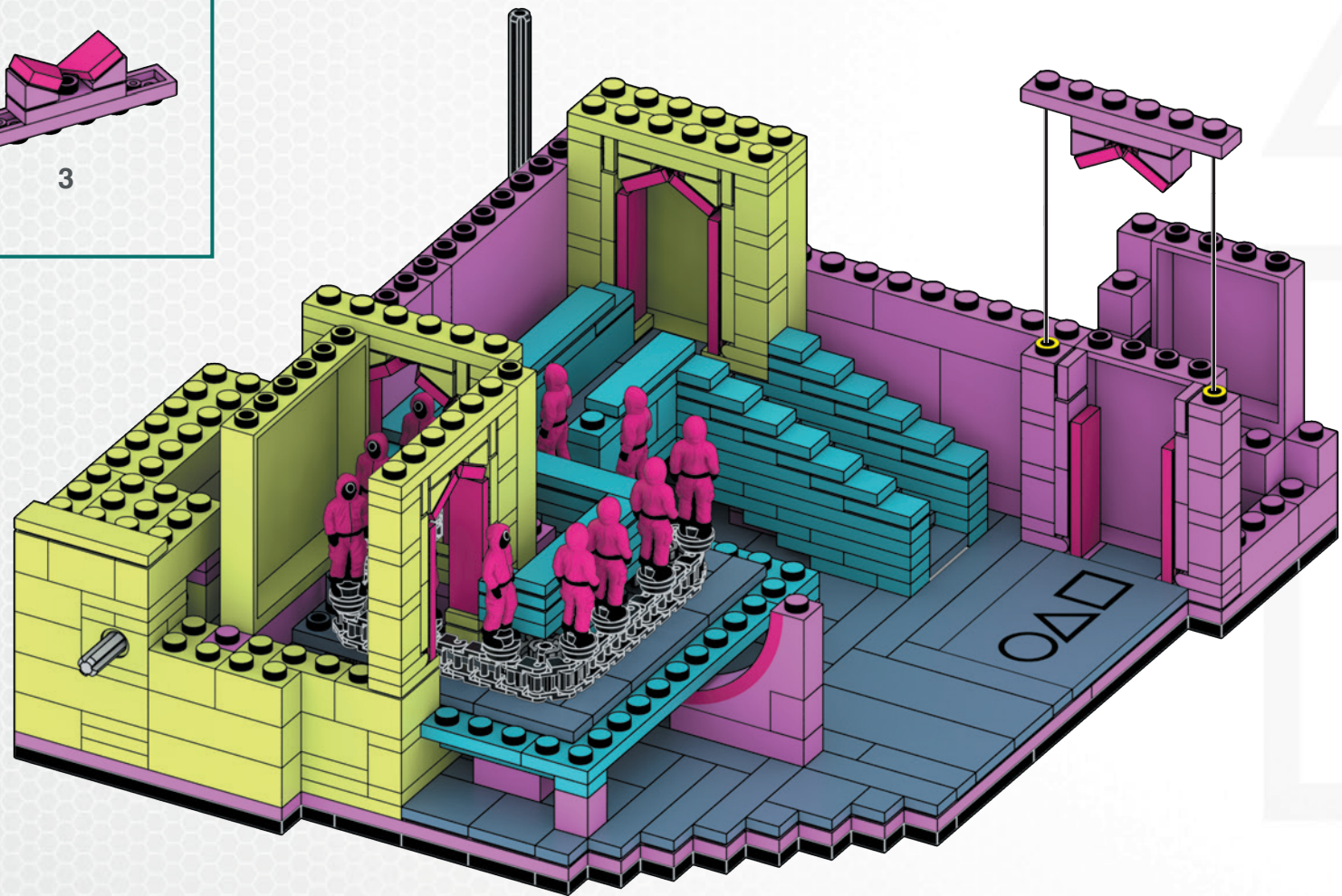
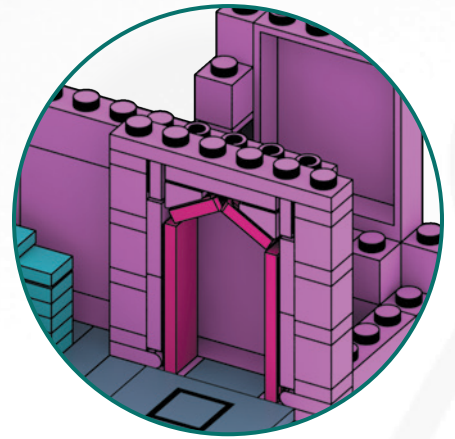
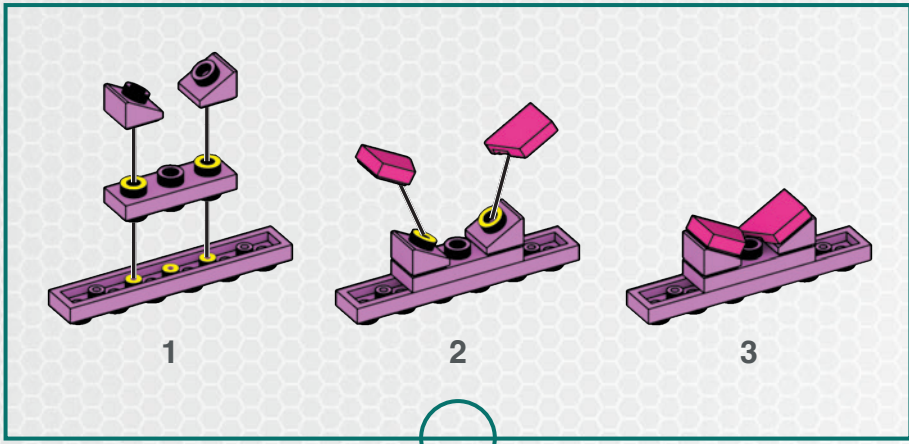

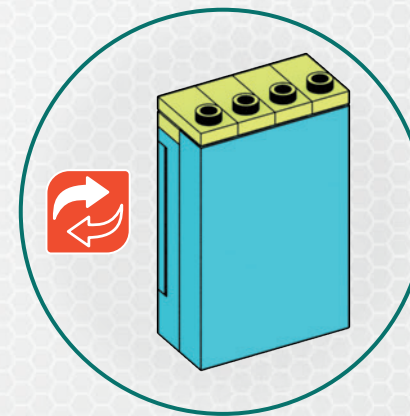
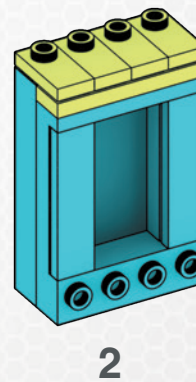
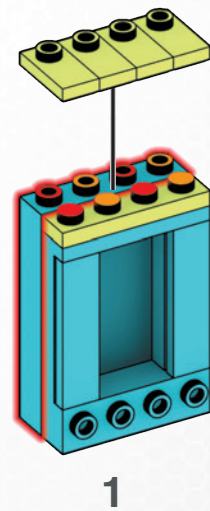
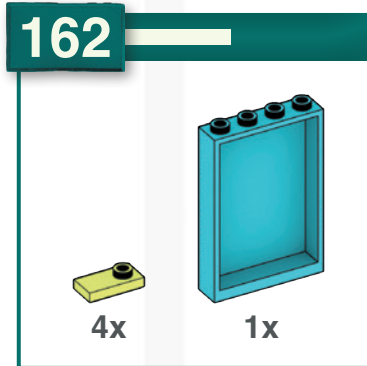
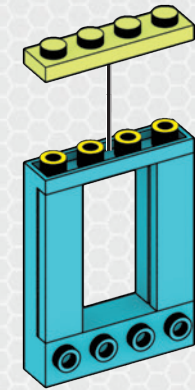
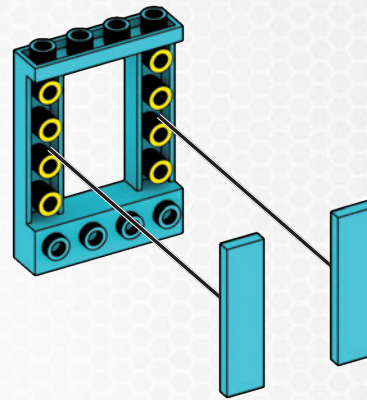
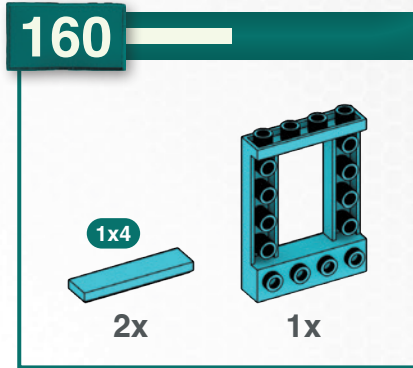

163



1x

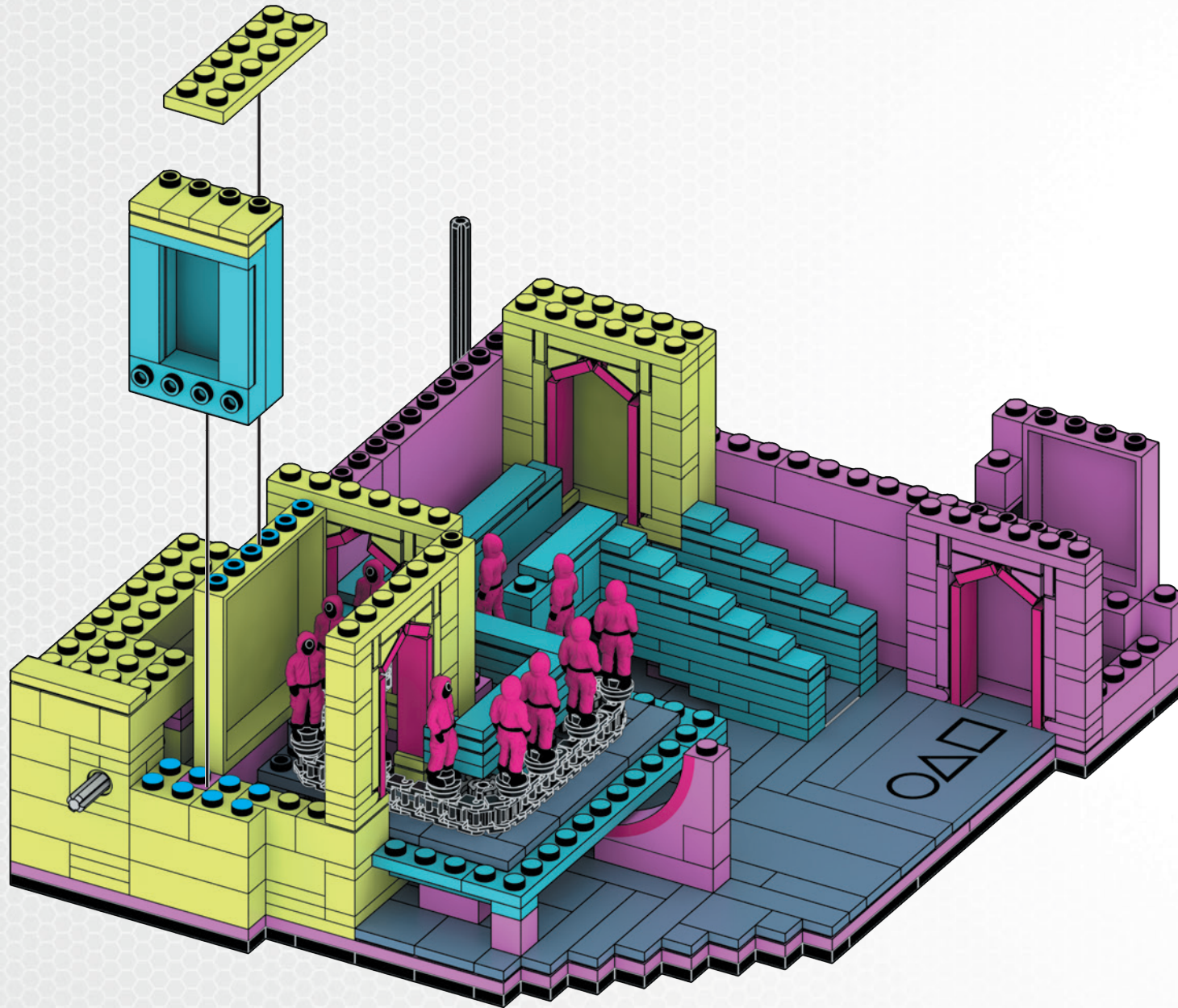

164



1x



1x

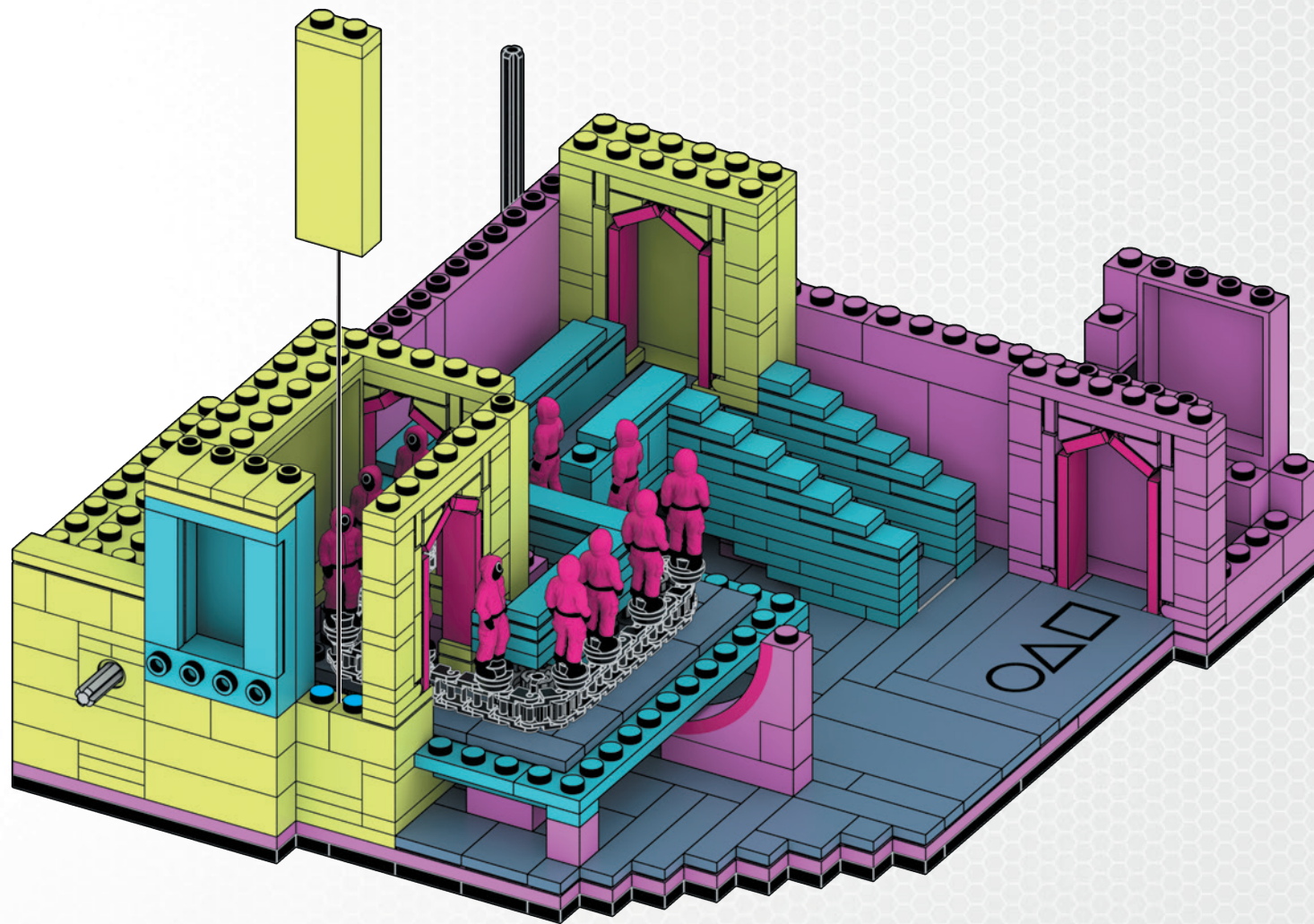
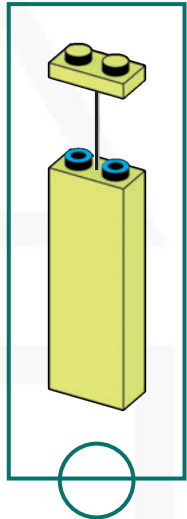

165

2x4



1x

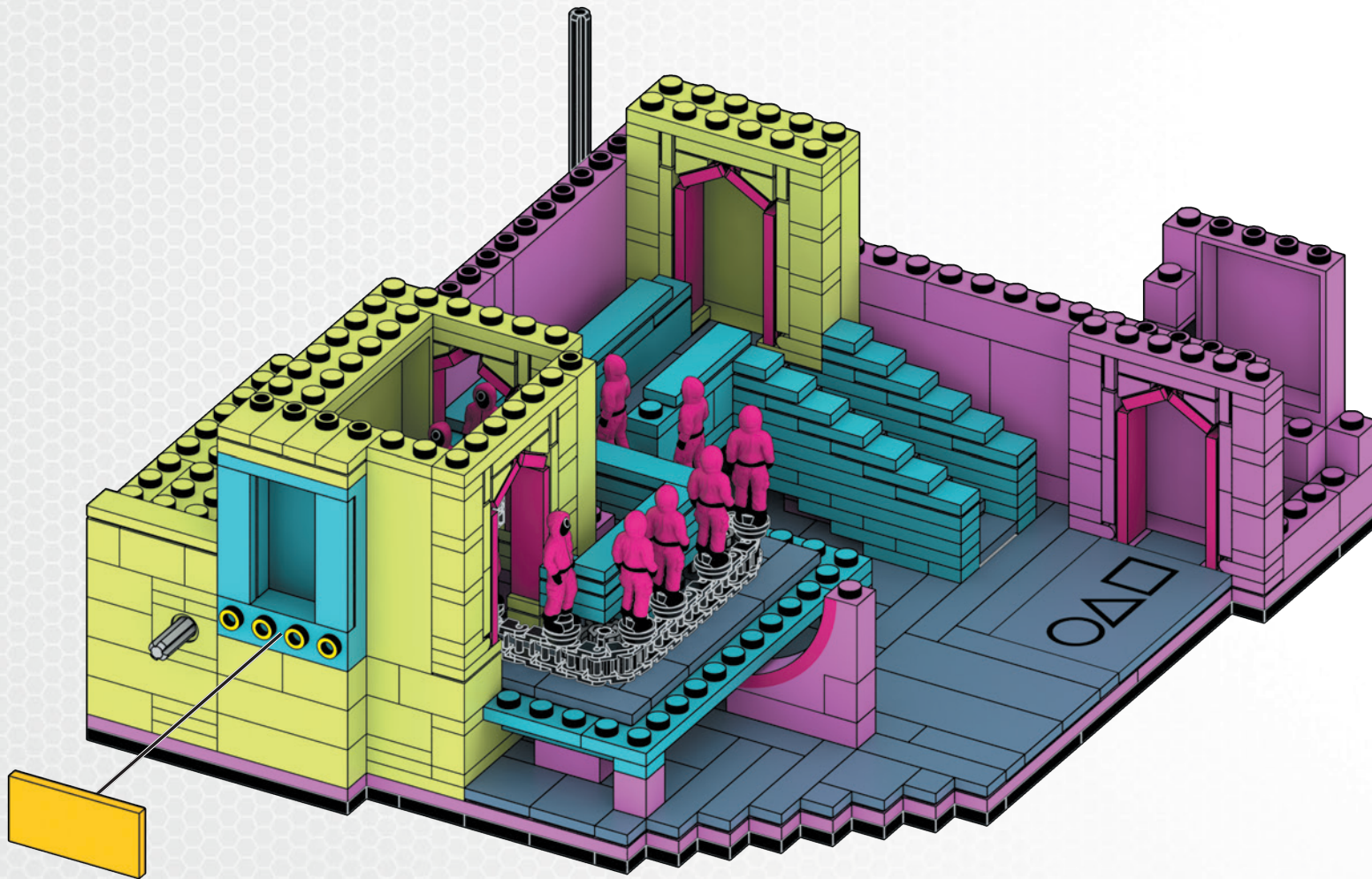
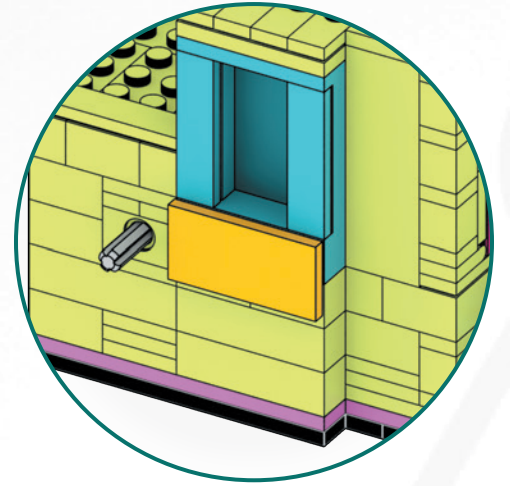

166

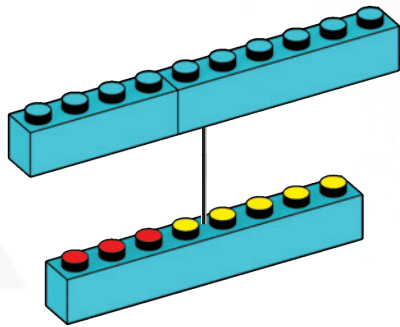
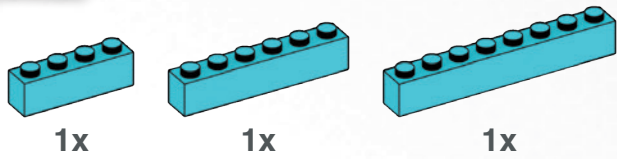

167

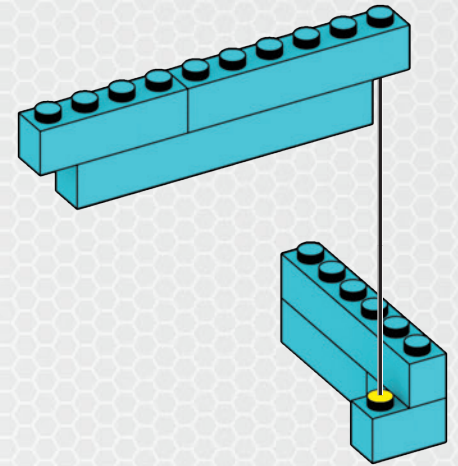
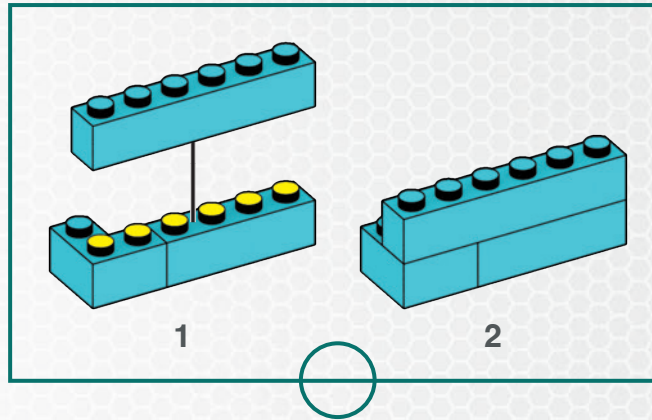
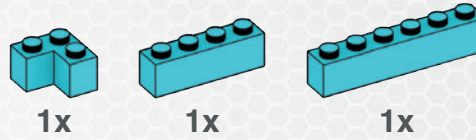

168

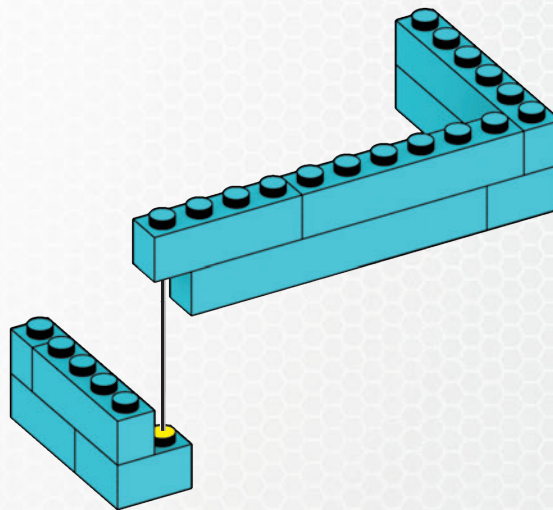
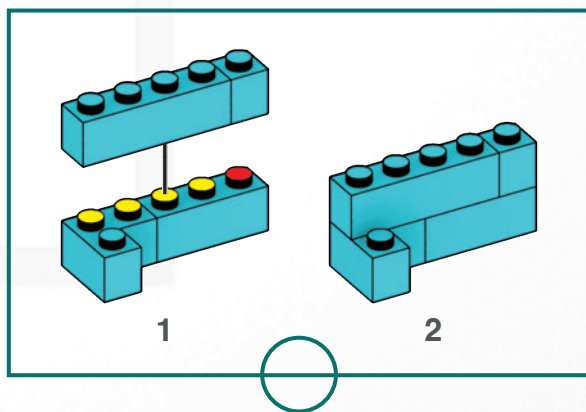
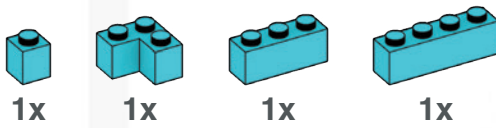

169

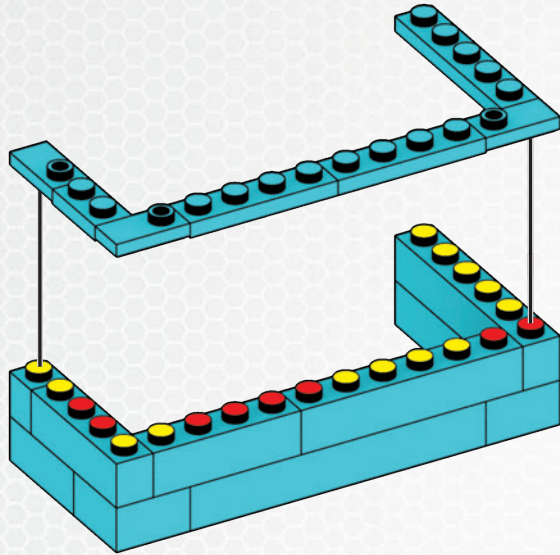
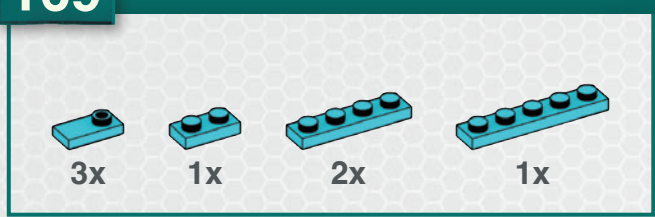

170

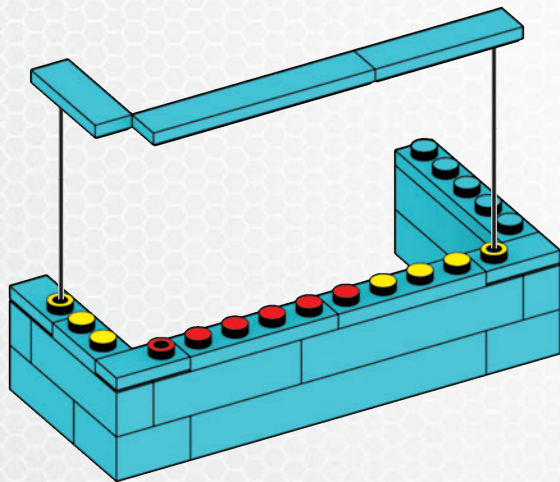
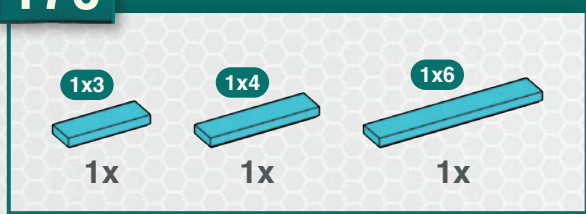

1

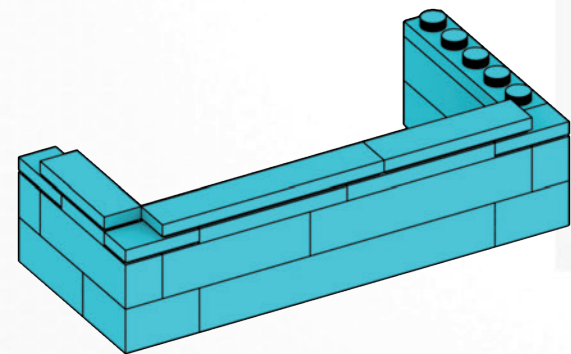

2

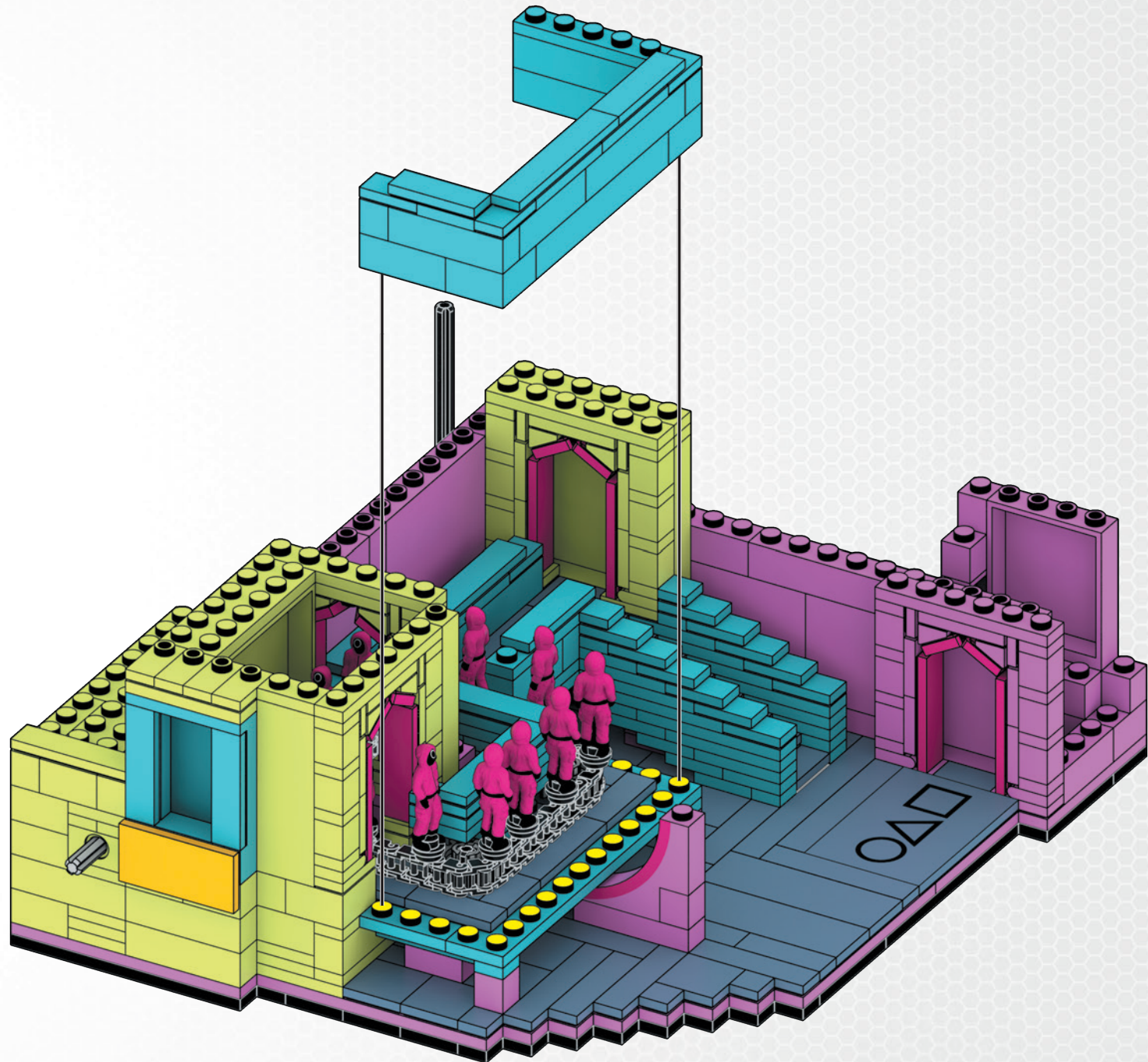

172

1x6



1x

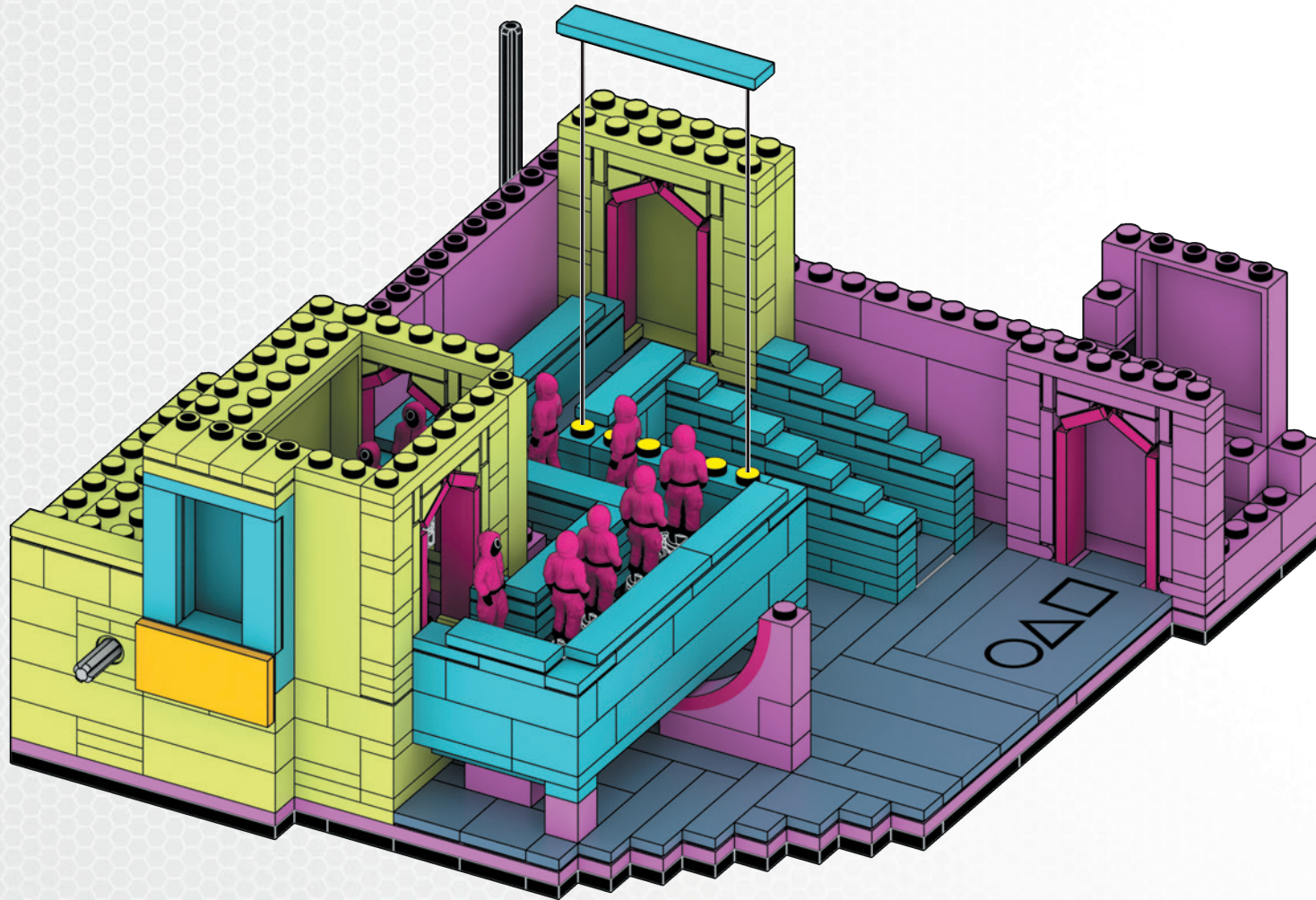
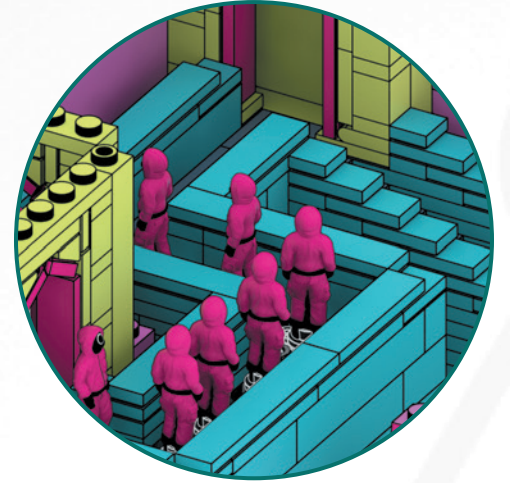

173

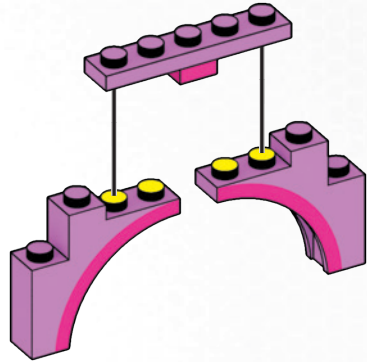
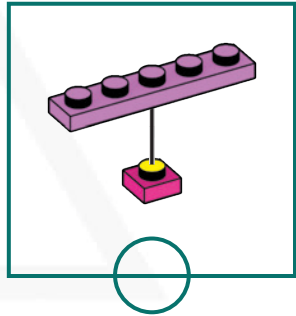
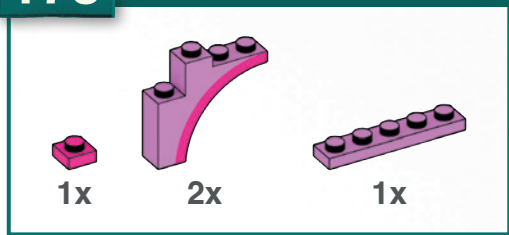

174

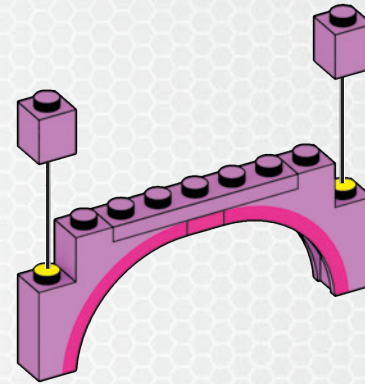
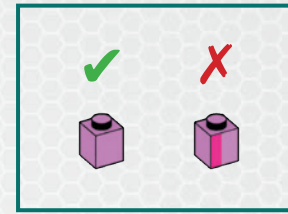
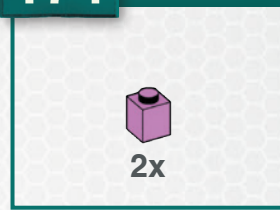

175

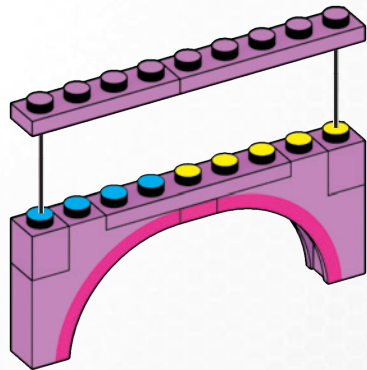
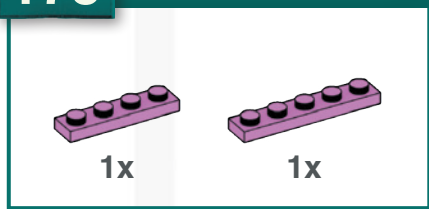

176

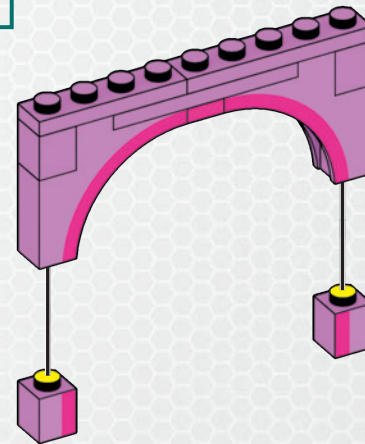

1

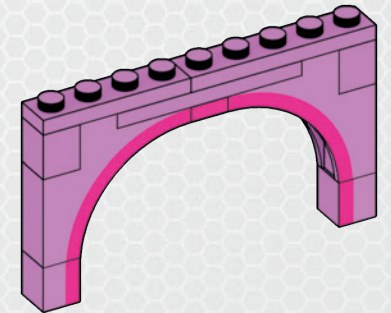

2

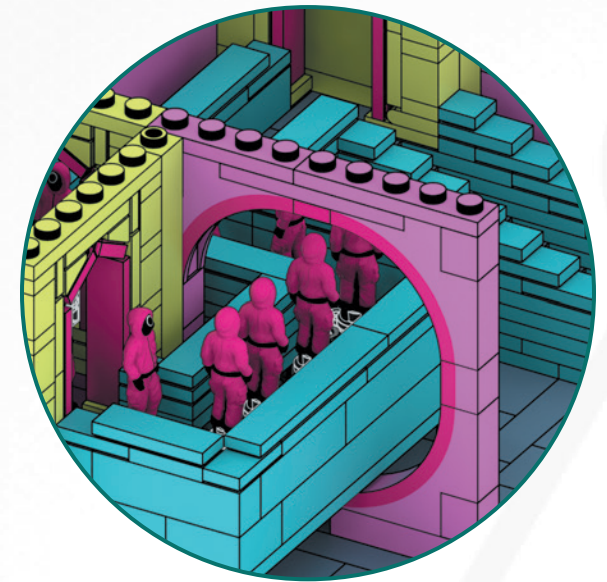
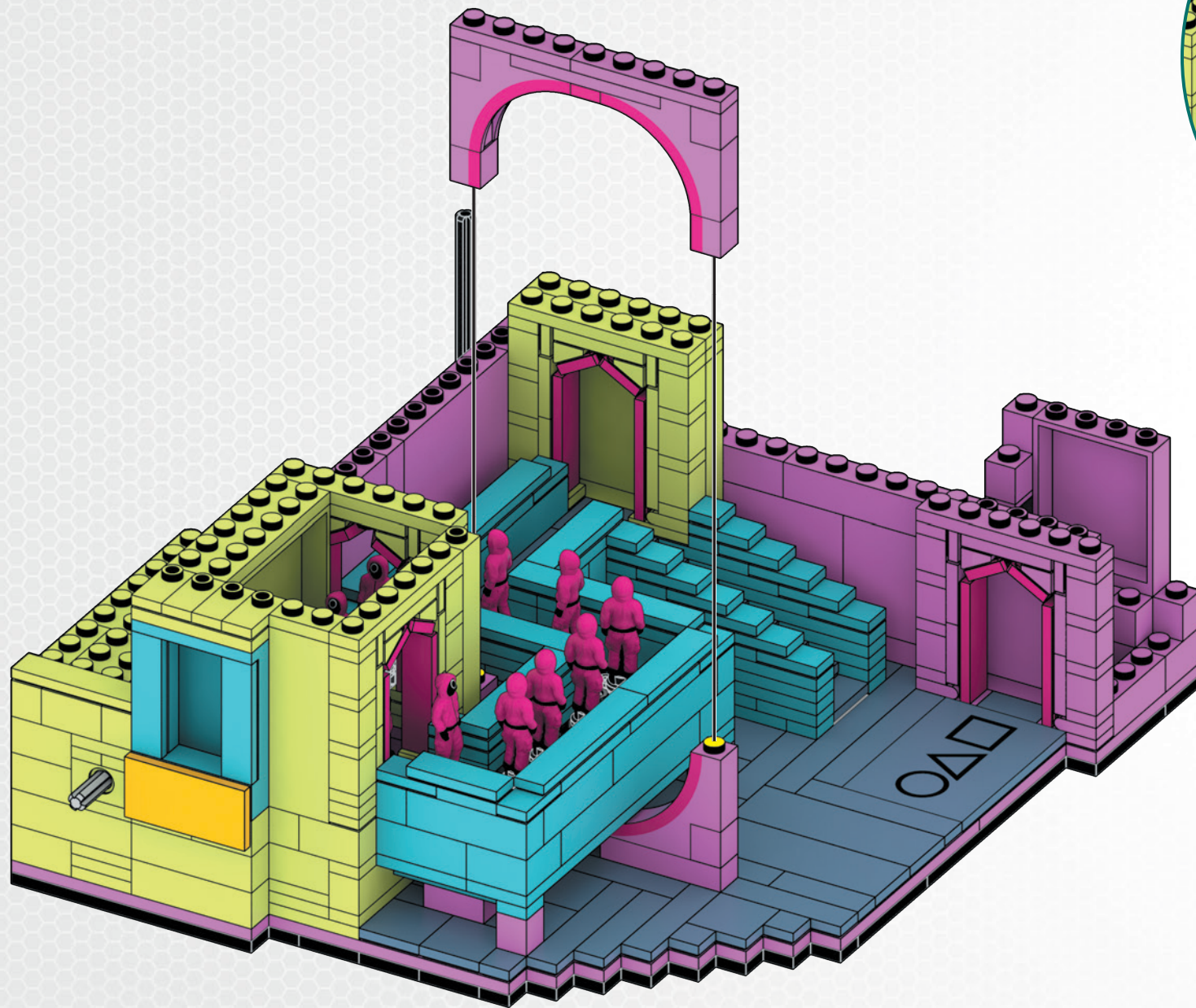

178



1x



1x

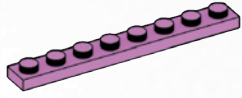

1x

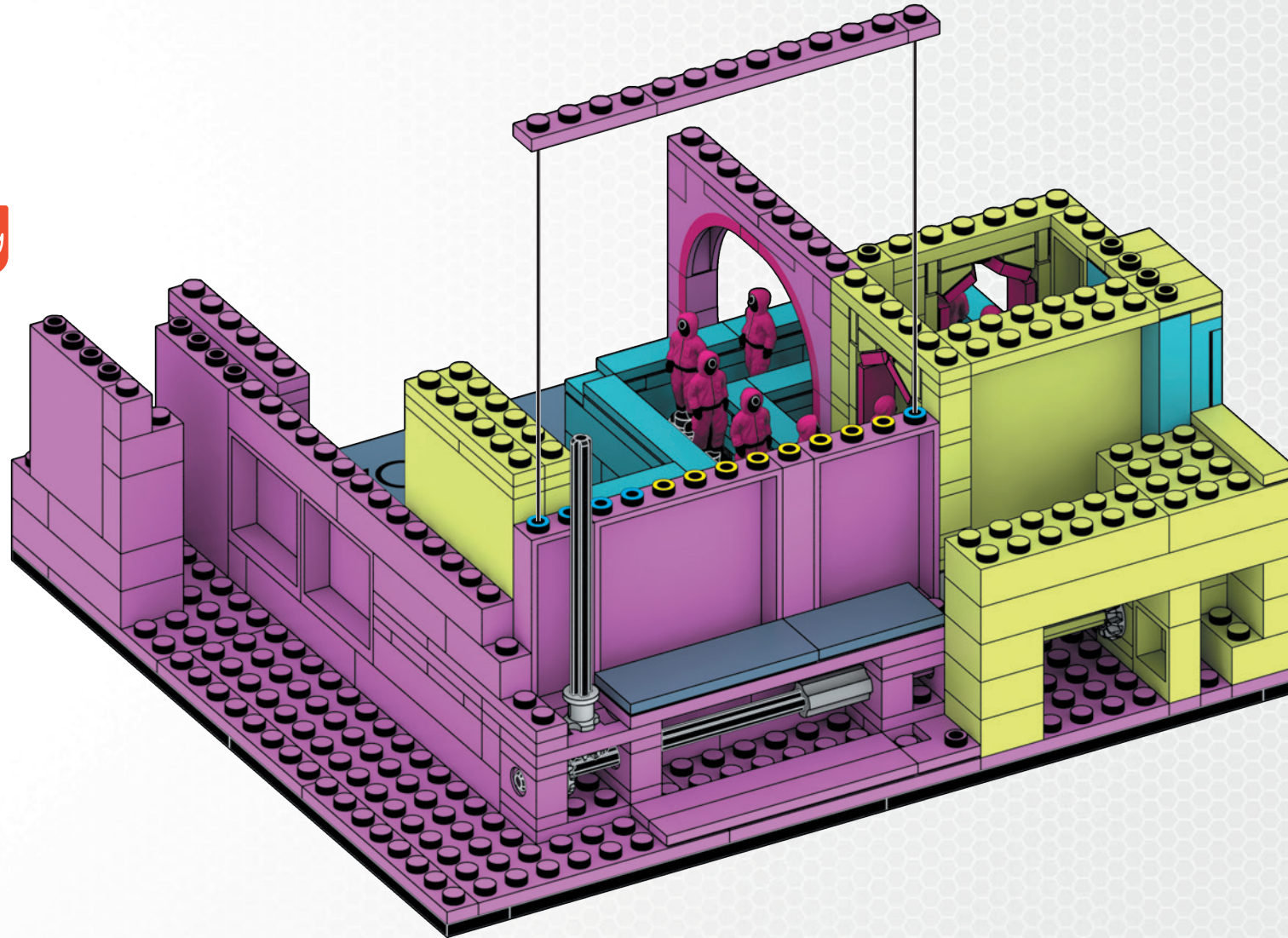

179



1x

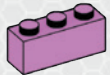

1x

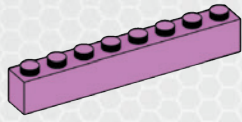

1x

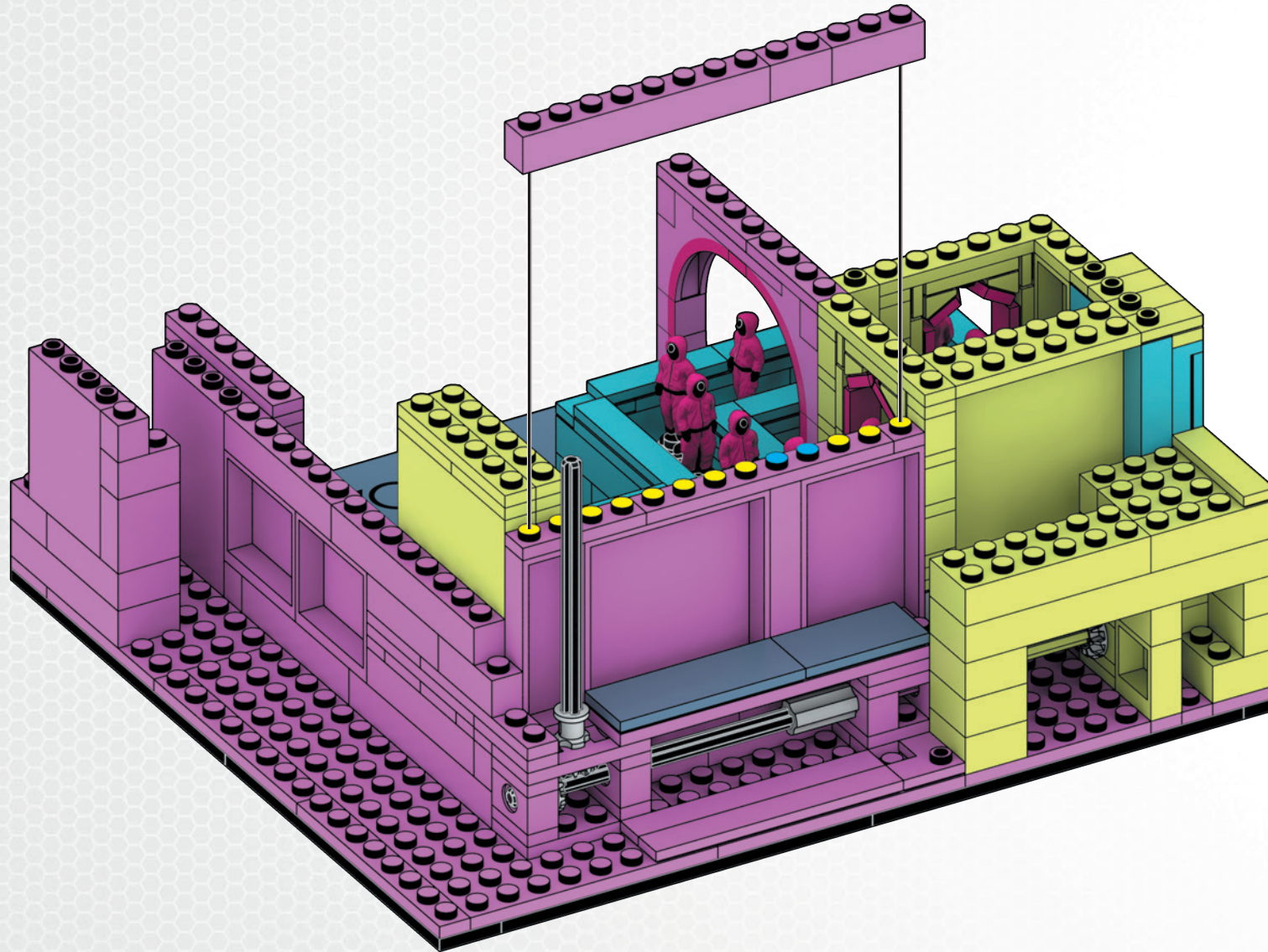

180



1x



1x

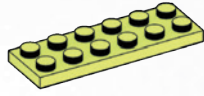

1x

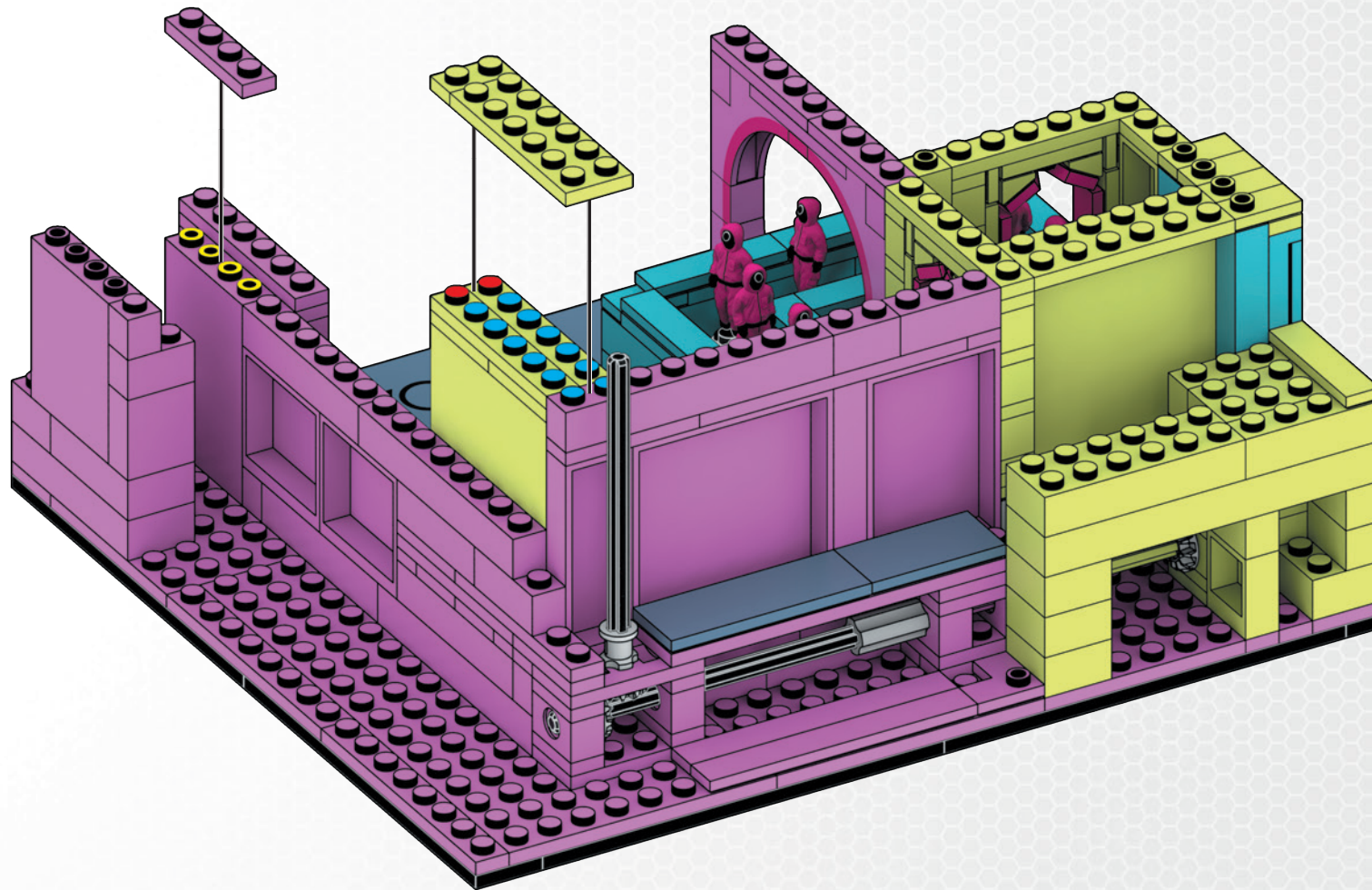

181

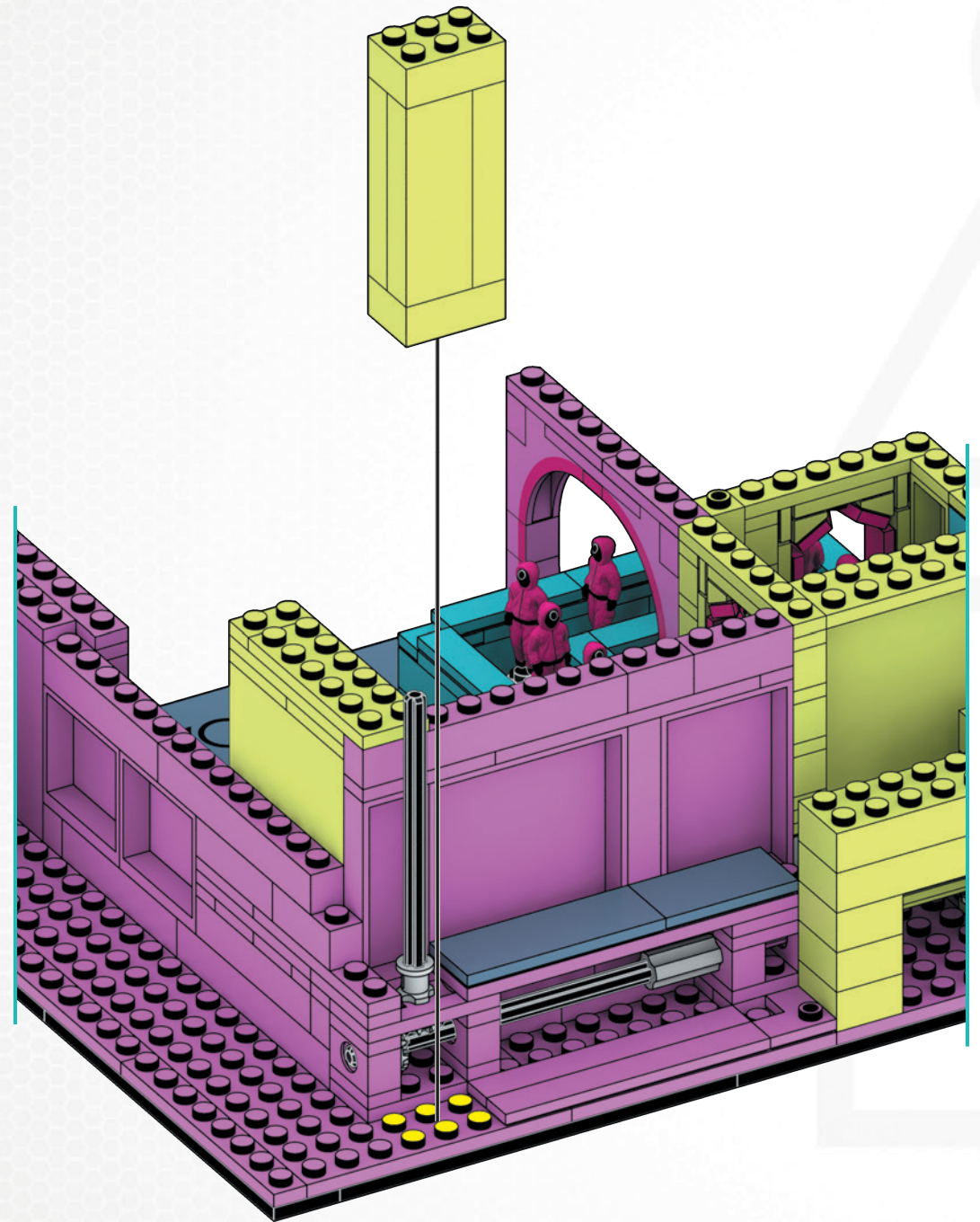
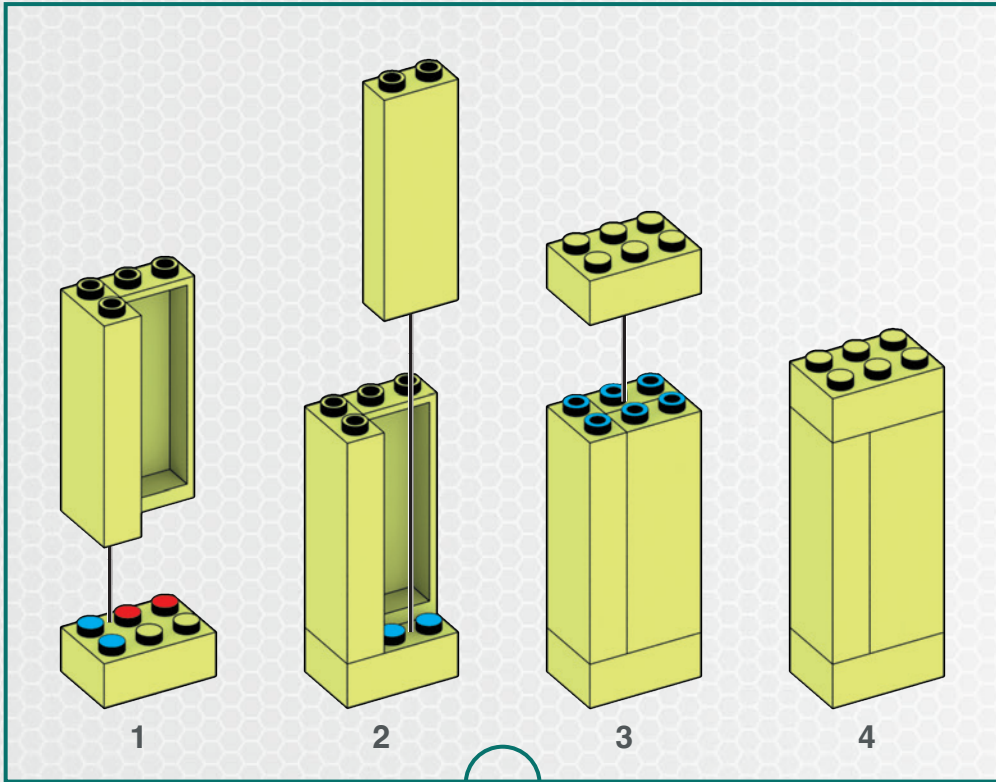
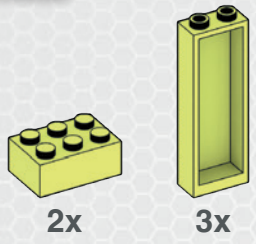

182



1x



1x

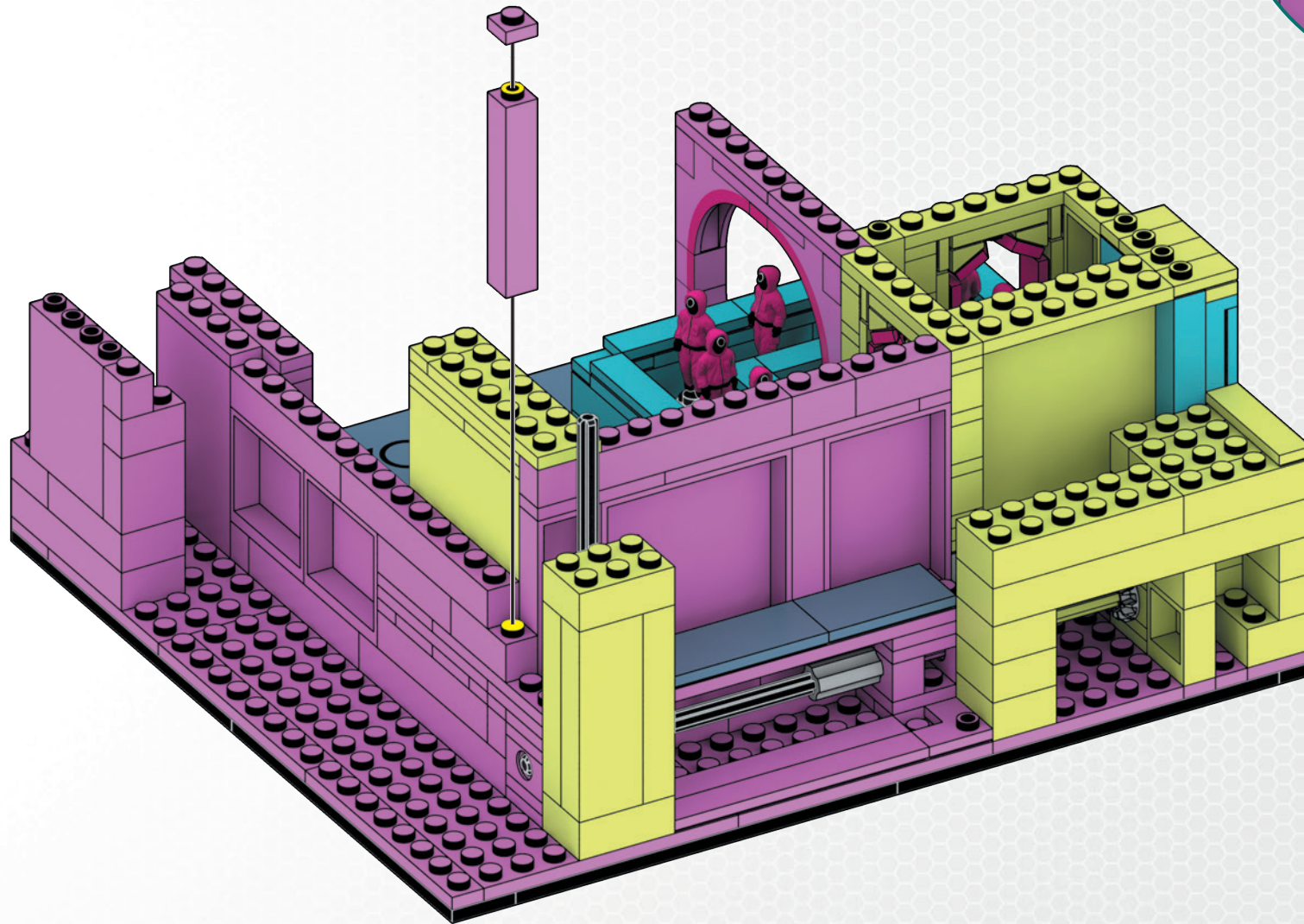

183



6x



1x

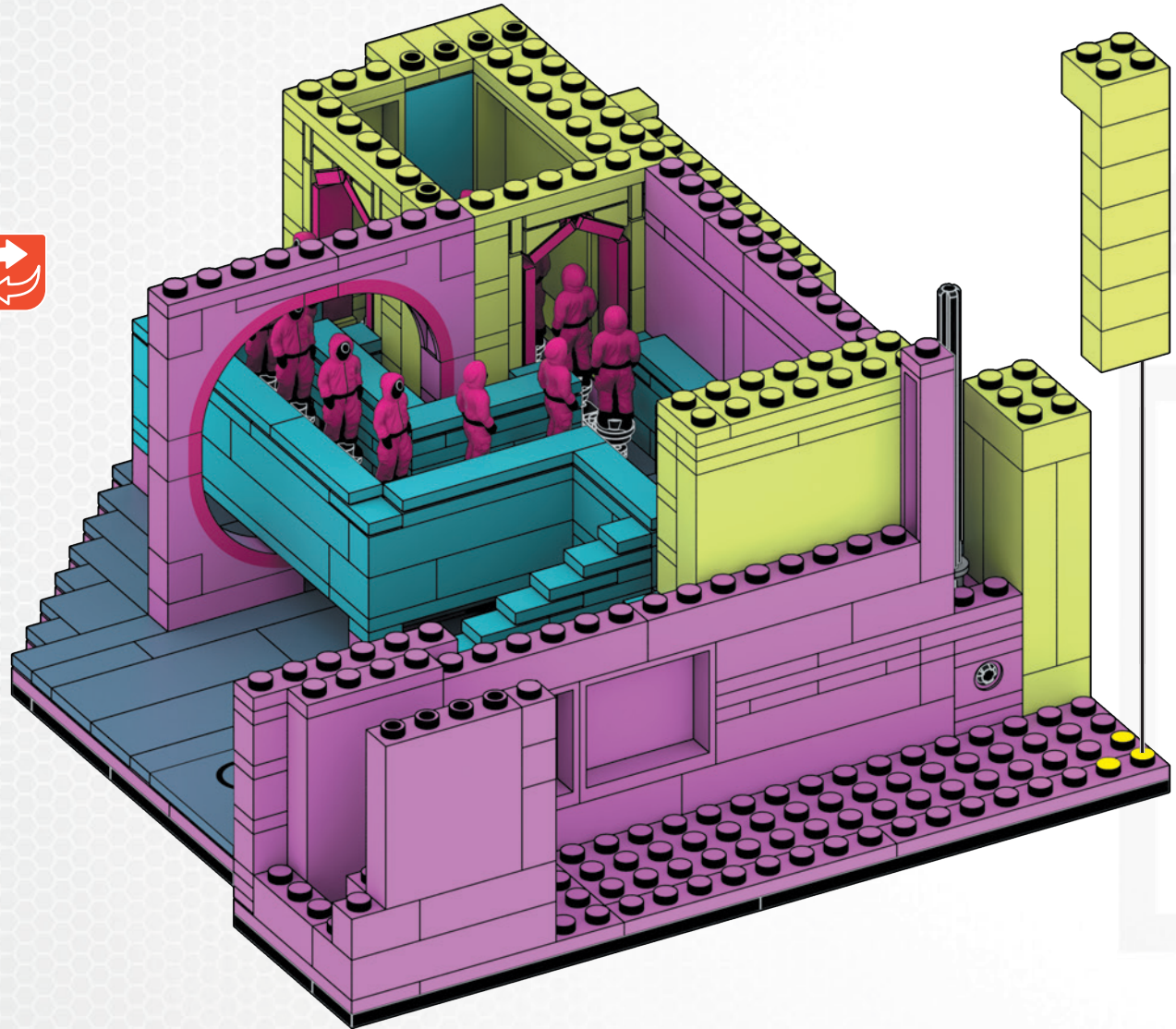
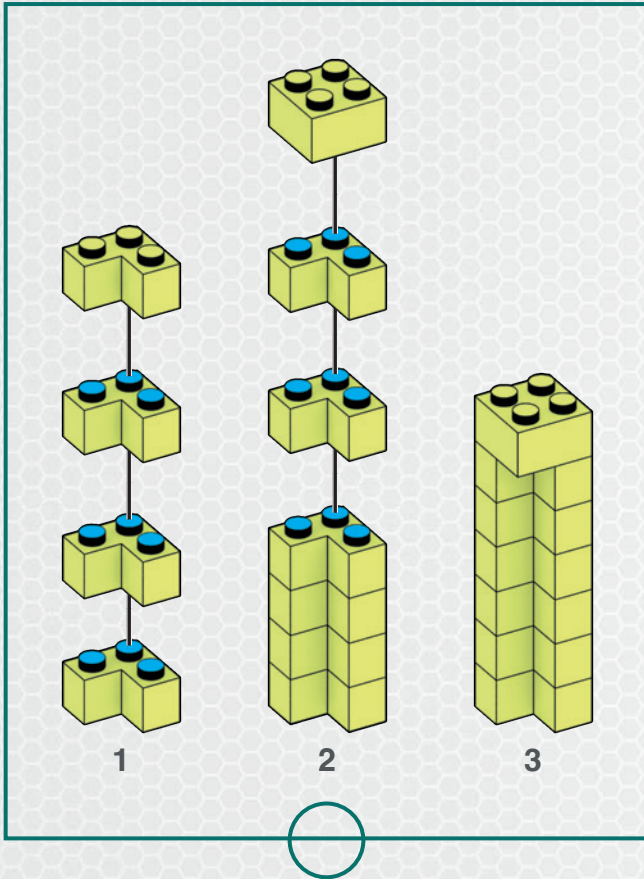

184

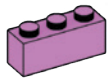

1x

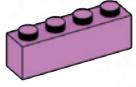

2x

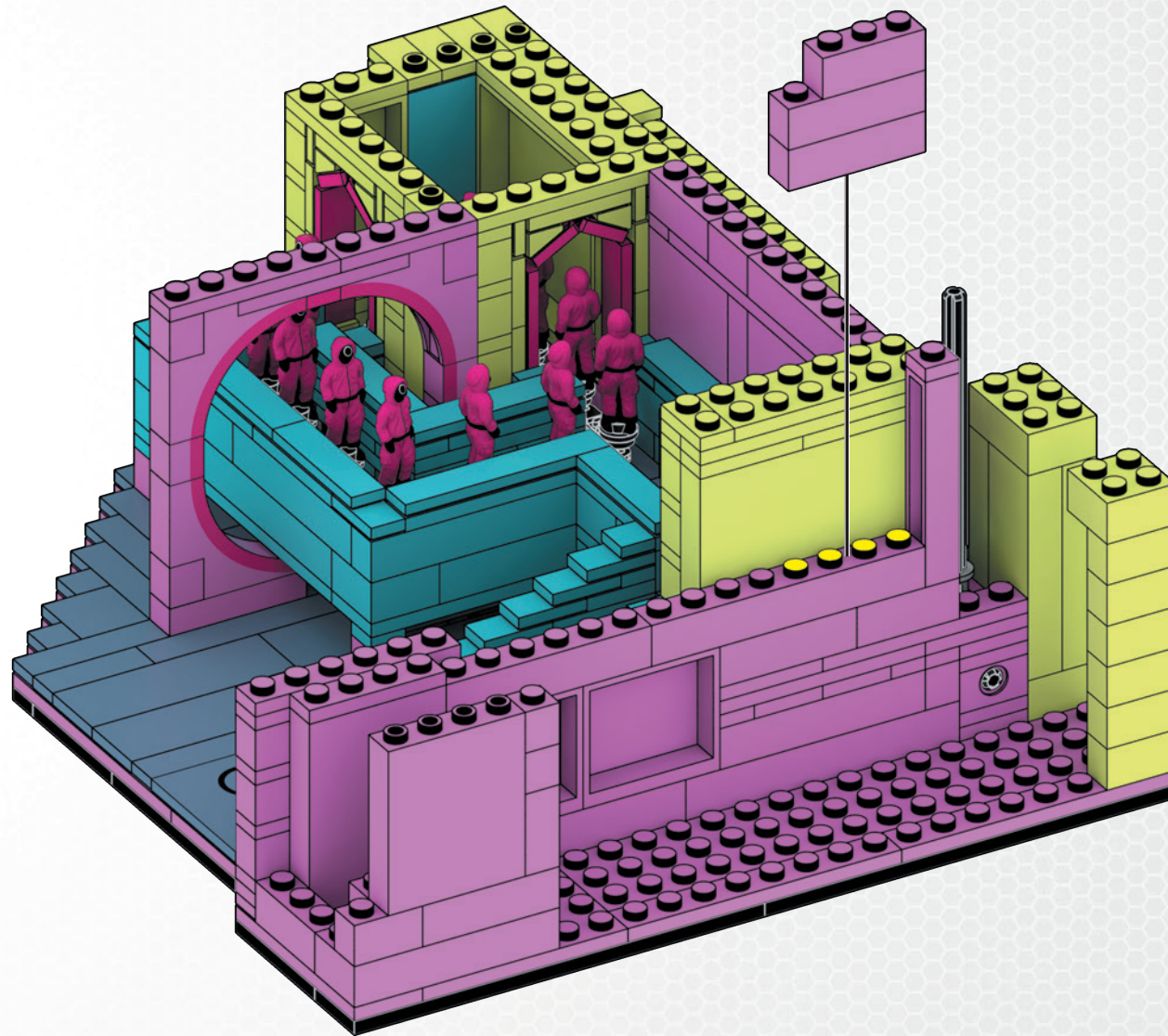
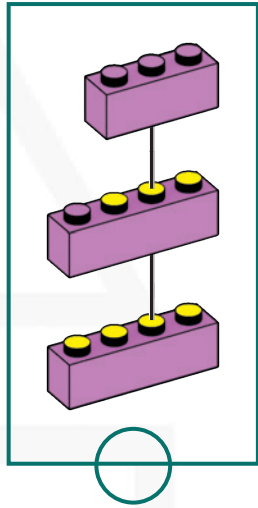

185

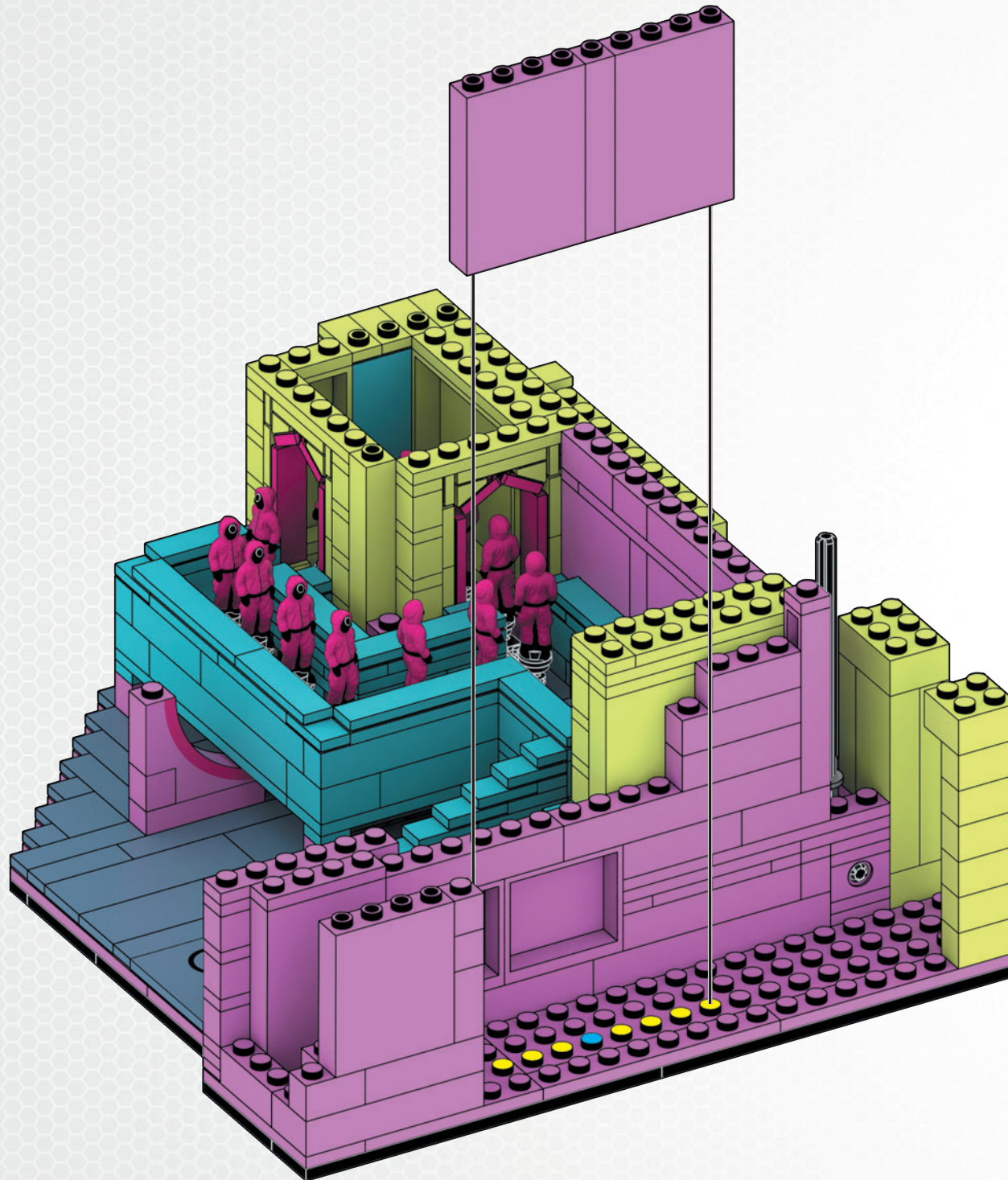
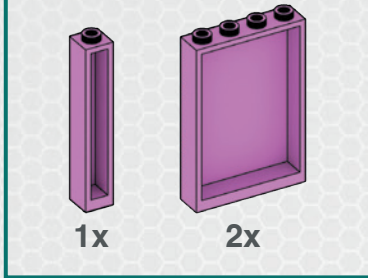

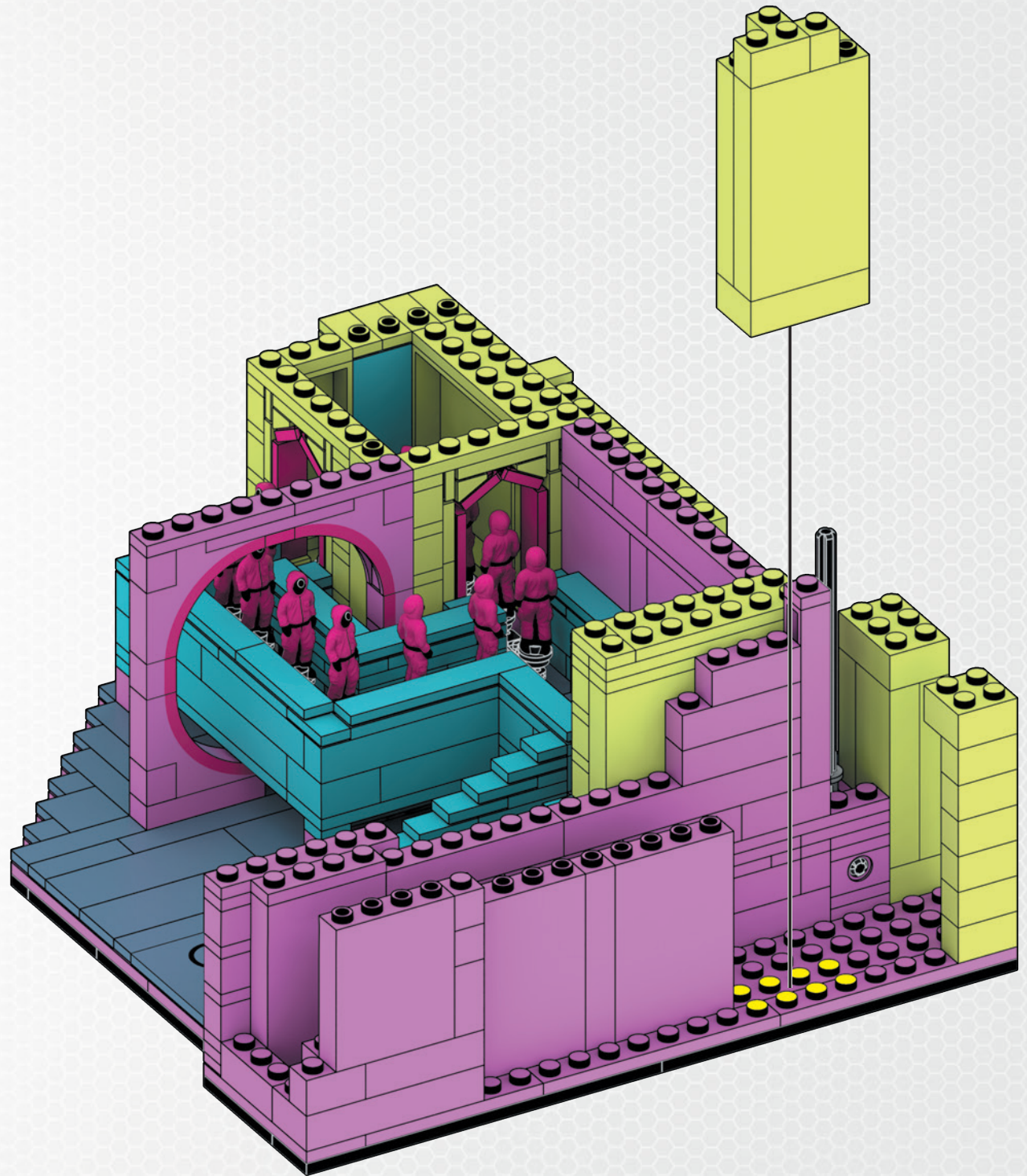
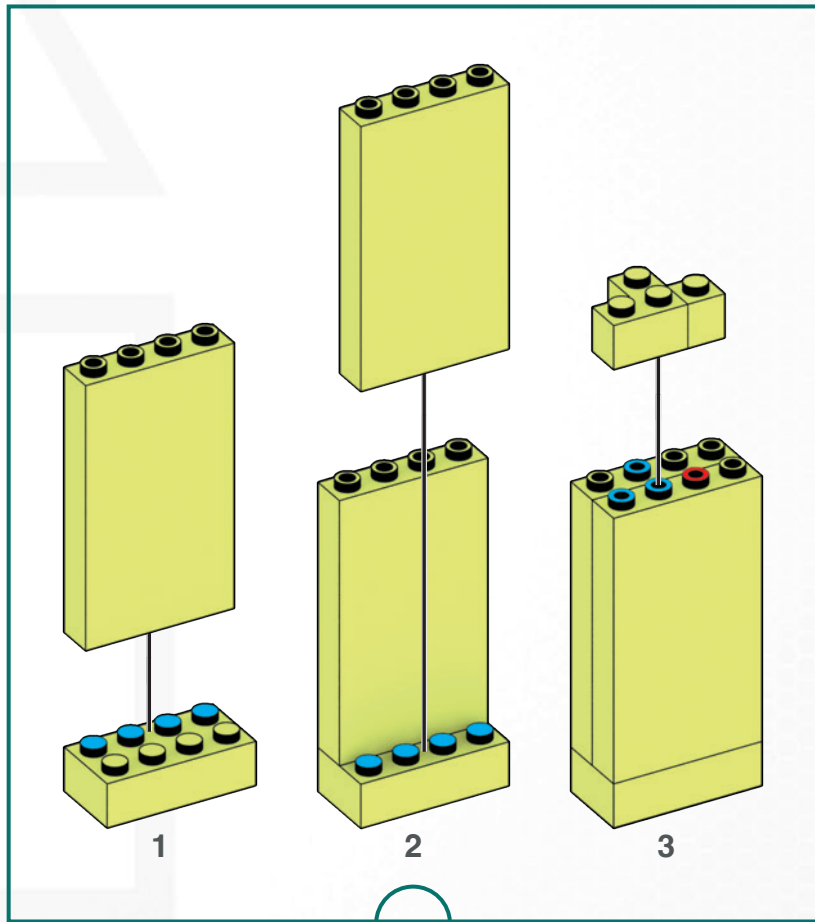
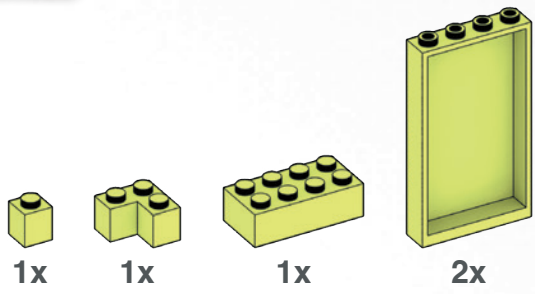

187

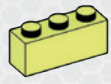



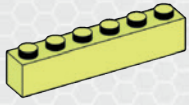

1x

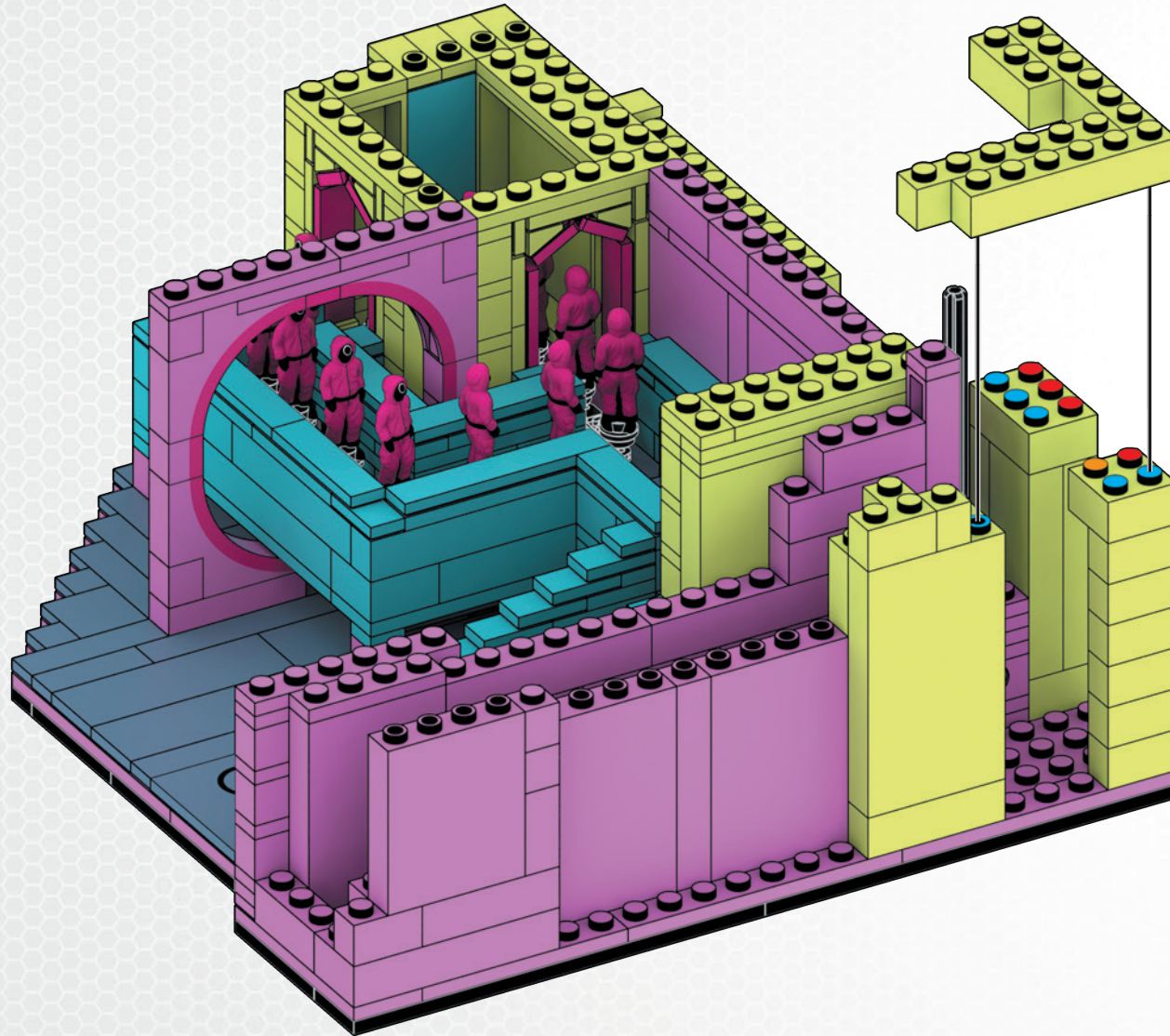

3x

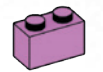
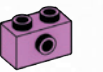

188

- 1x 
- 1x 
- 1x 
- 1x 
- 2x 

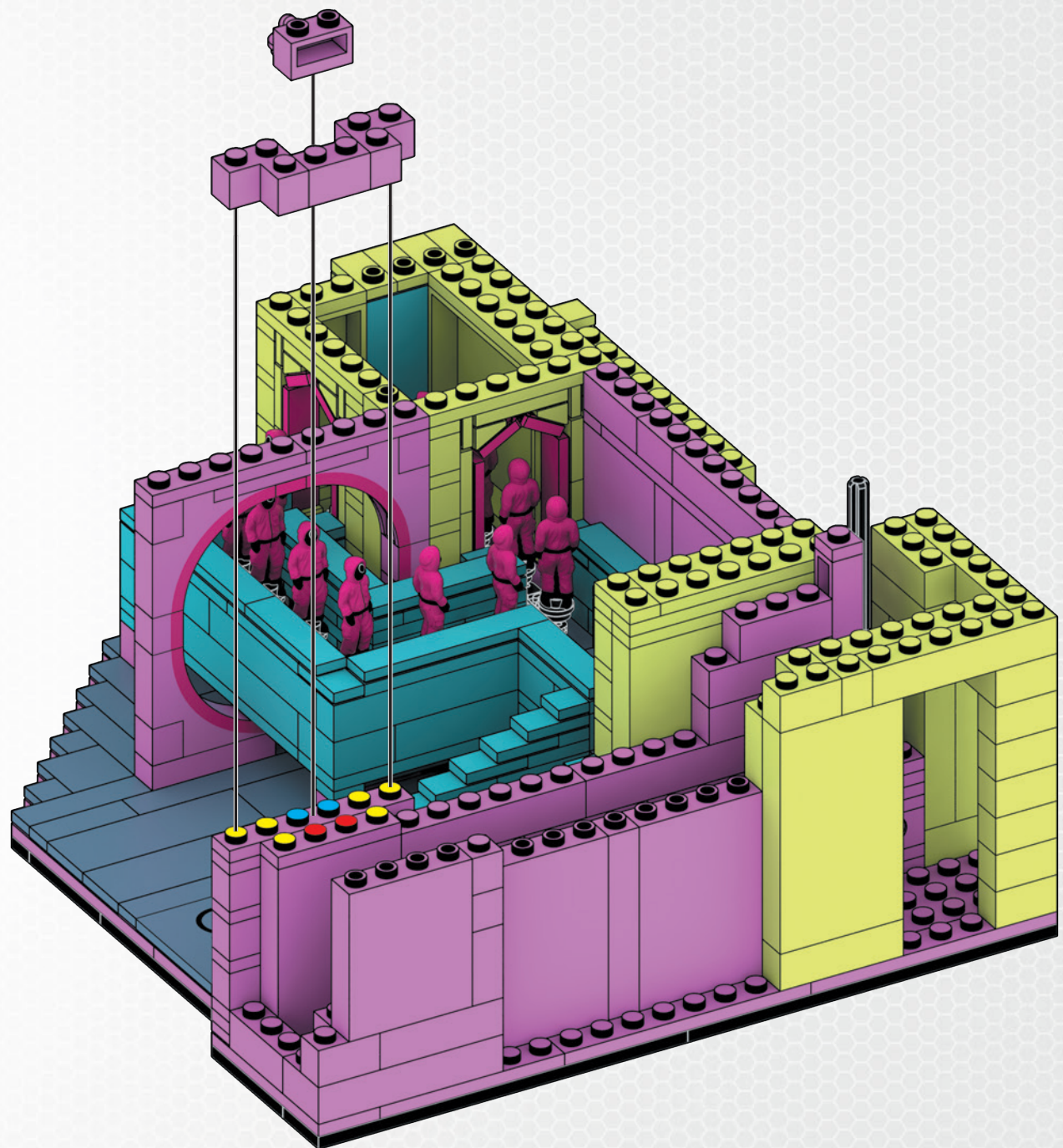
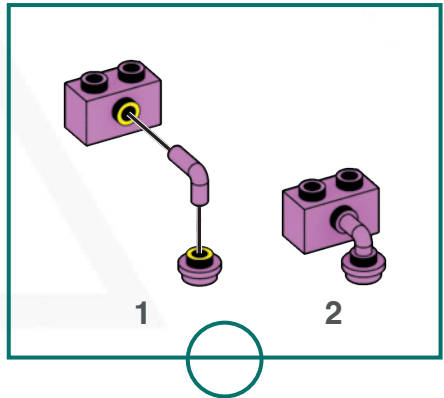

189



1x



1x

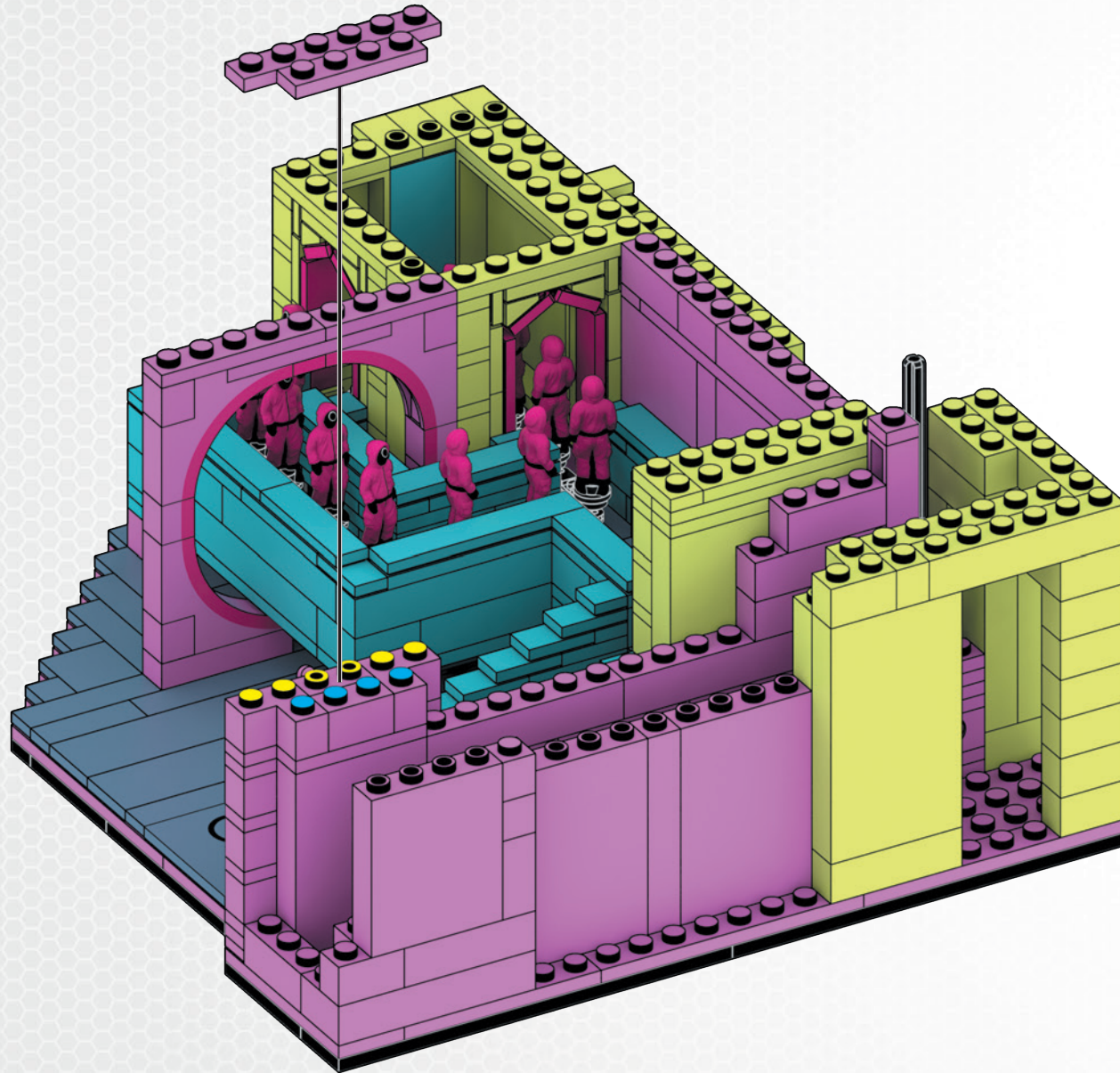

190

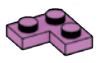

2x



1x

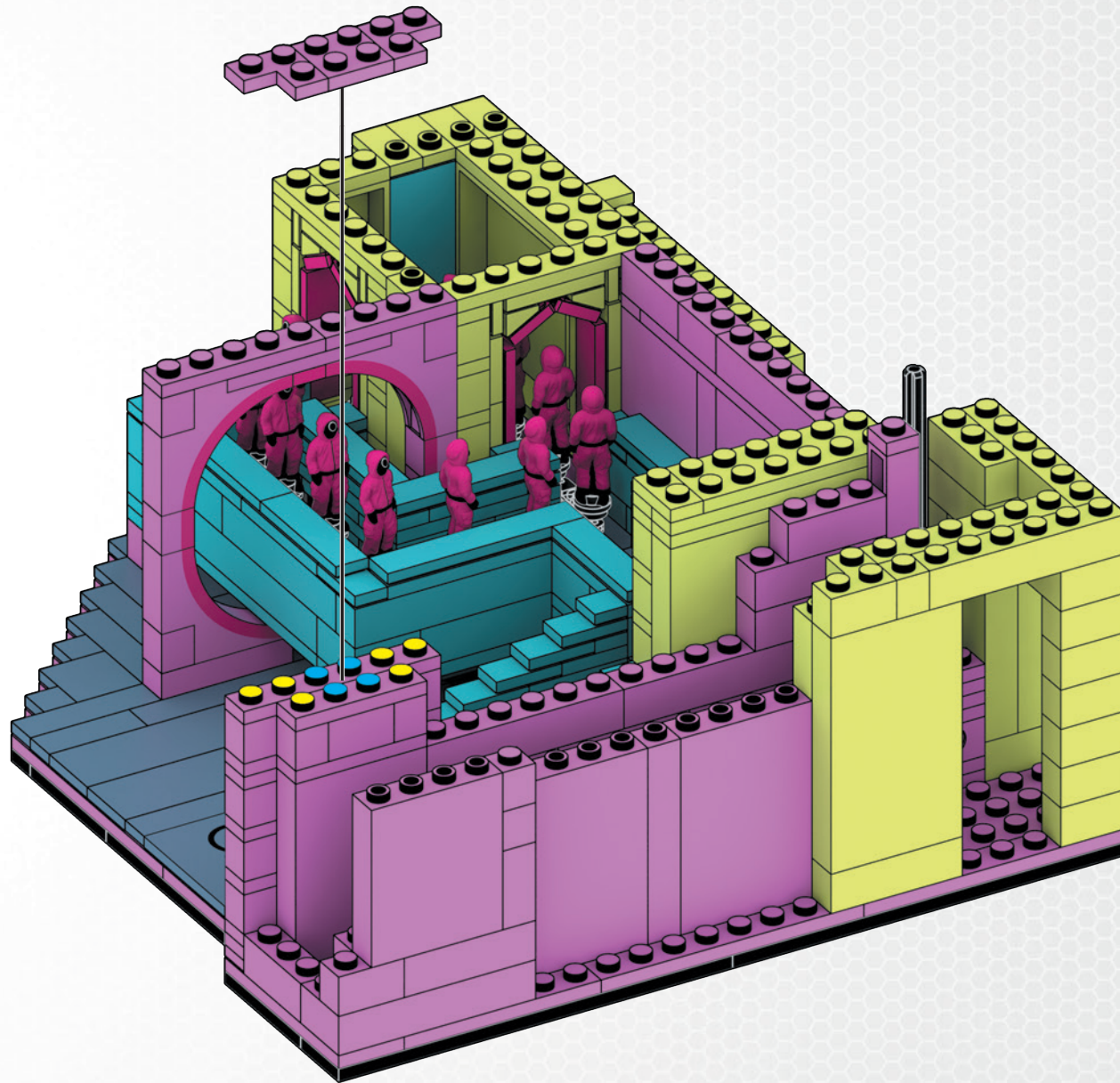

191



1x



1x

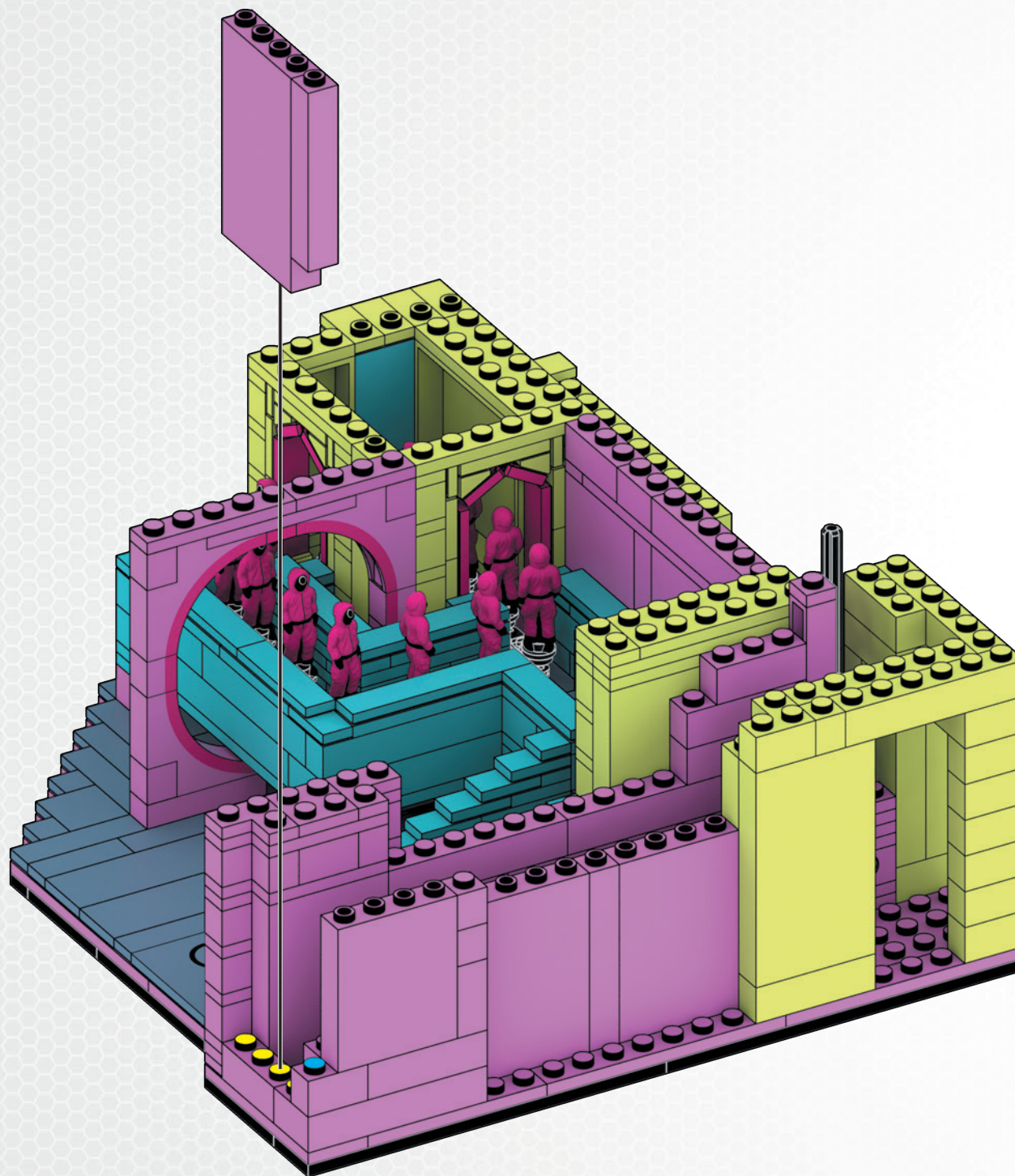

192



1x

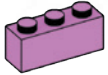

1x

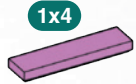

1x4

1x

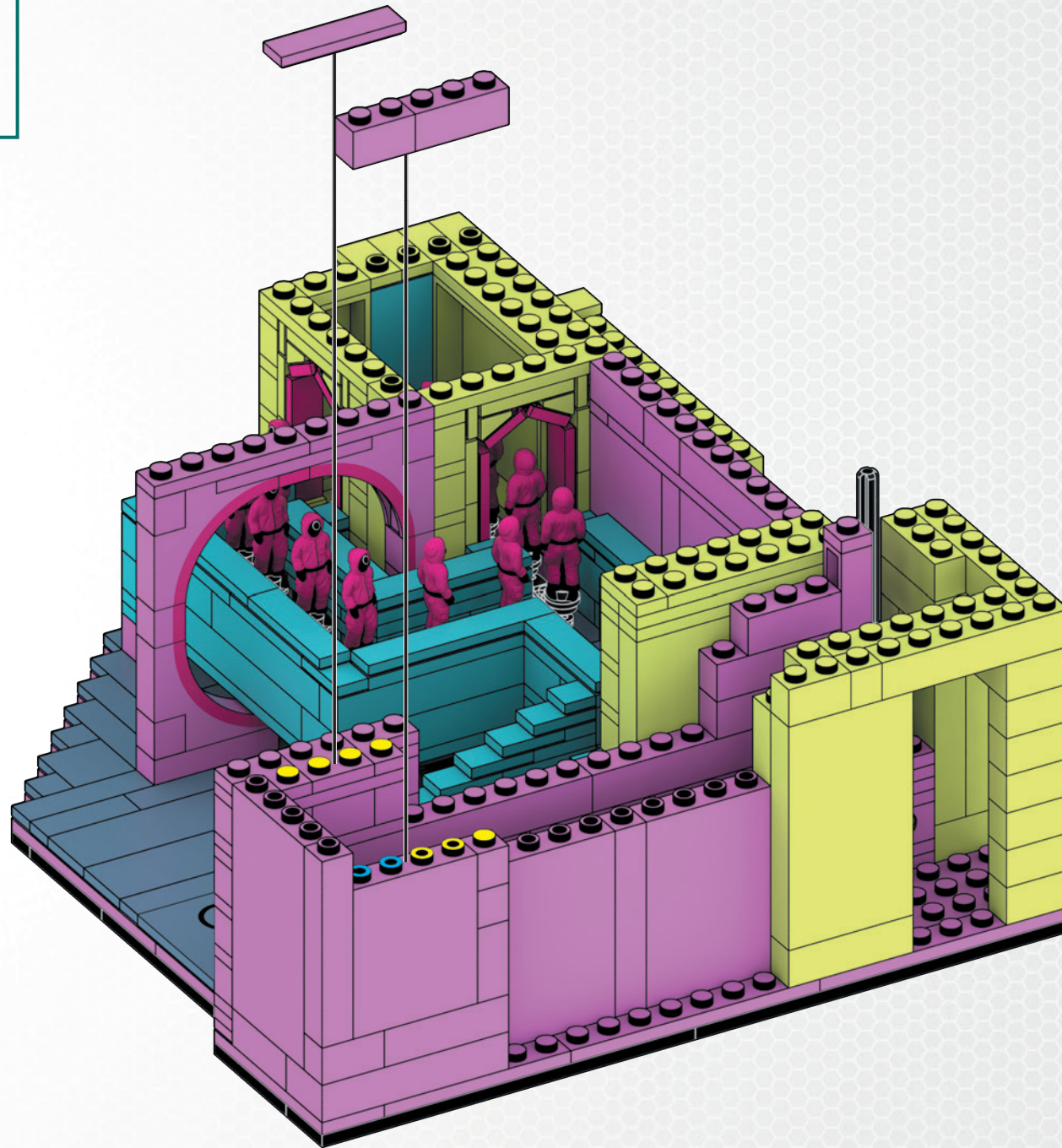

193

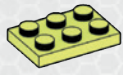

1x



1x



1x

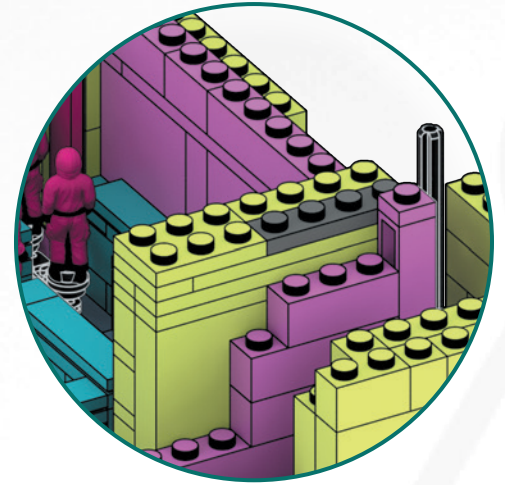
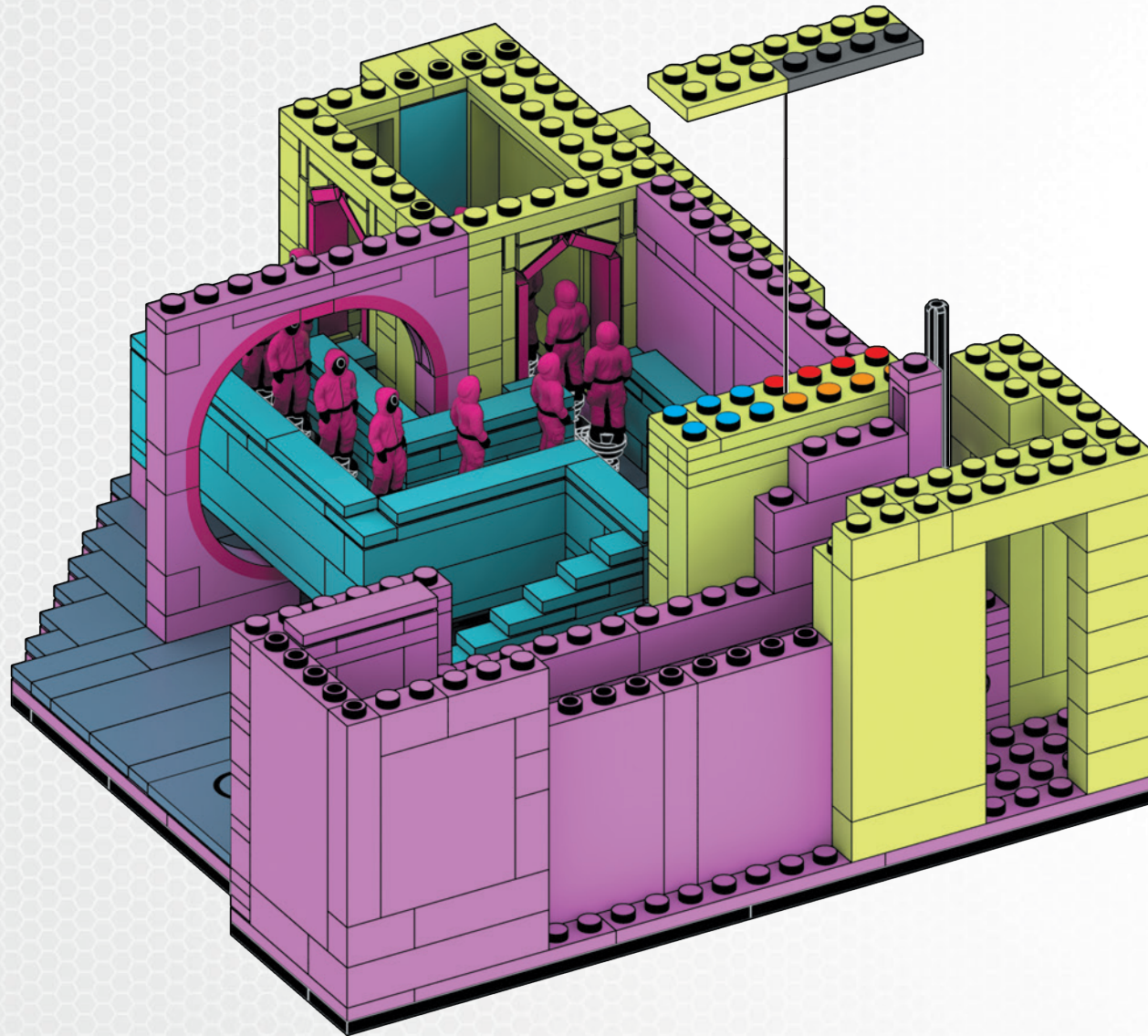

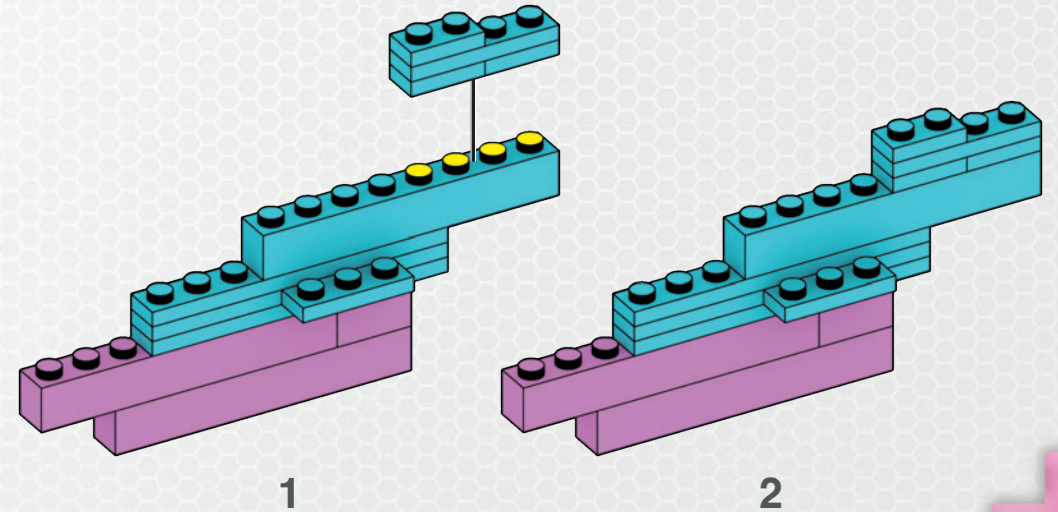
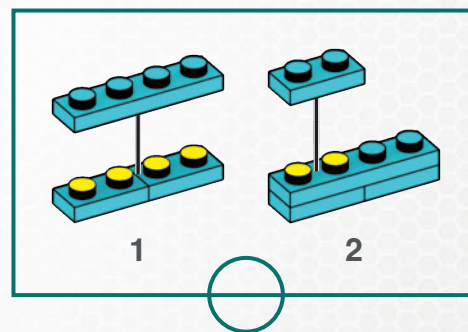
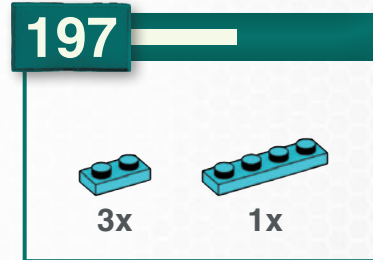
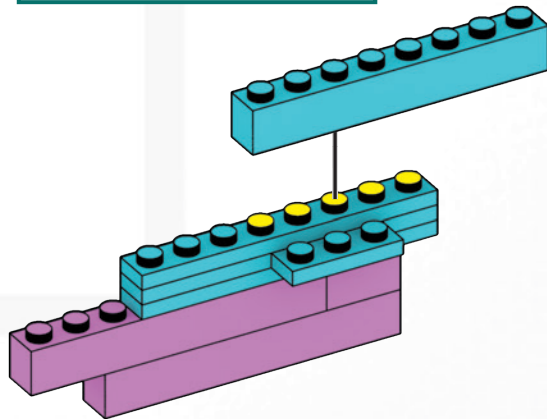
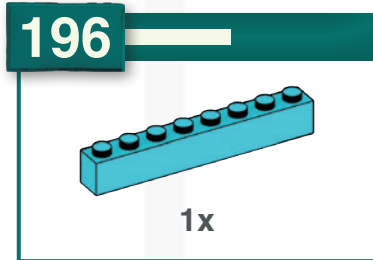
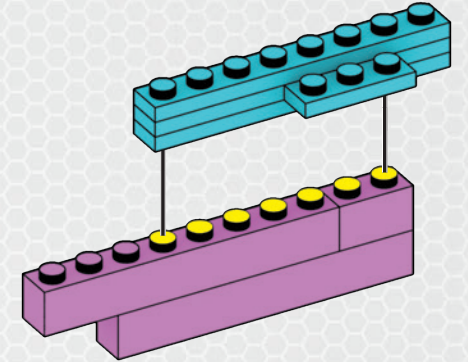
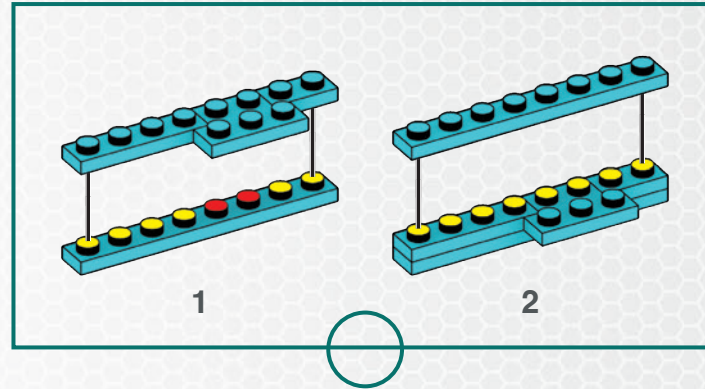
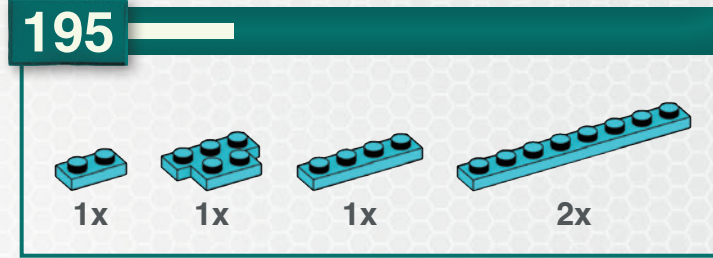
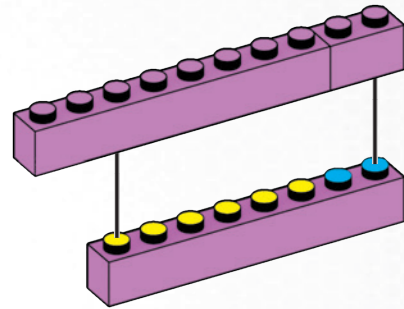
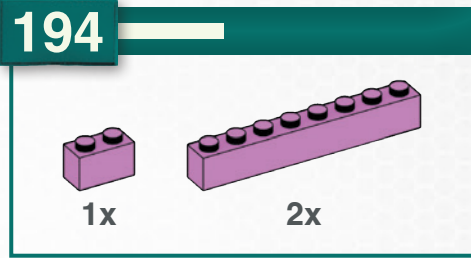

198

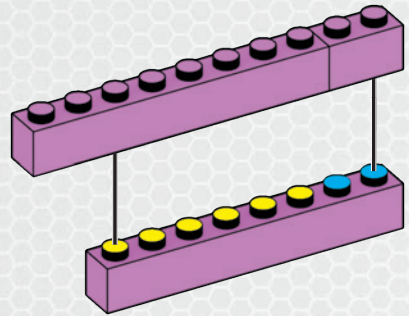
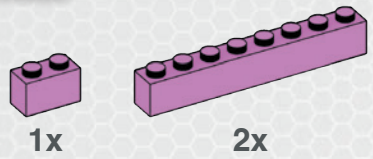

199

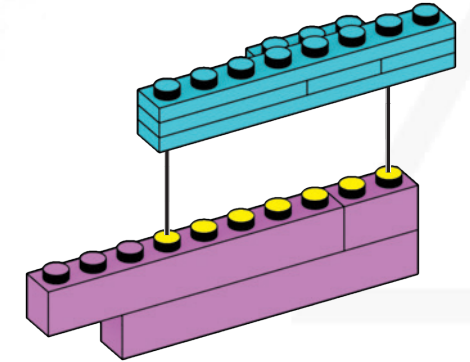
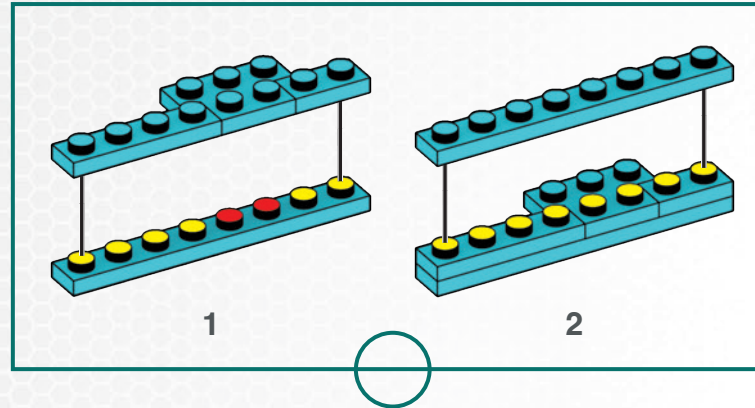
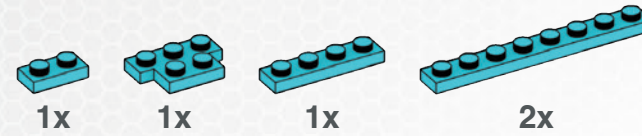

200

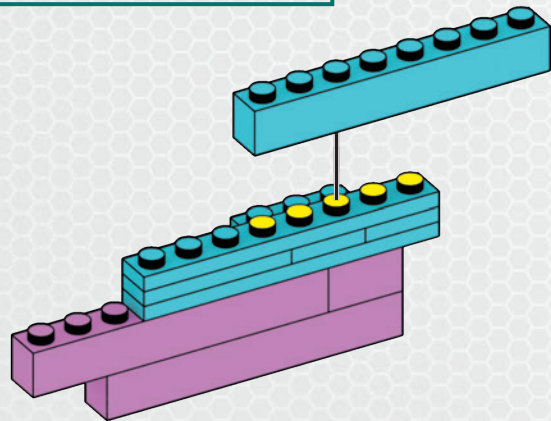
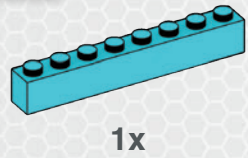

201

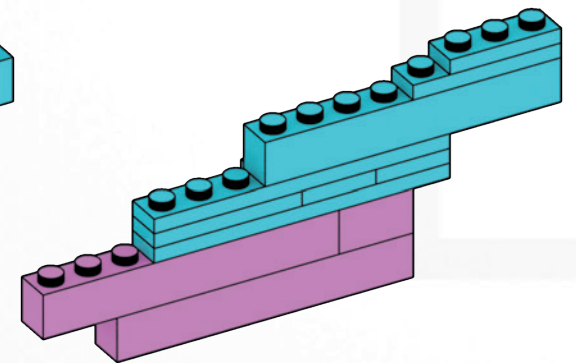
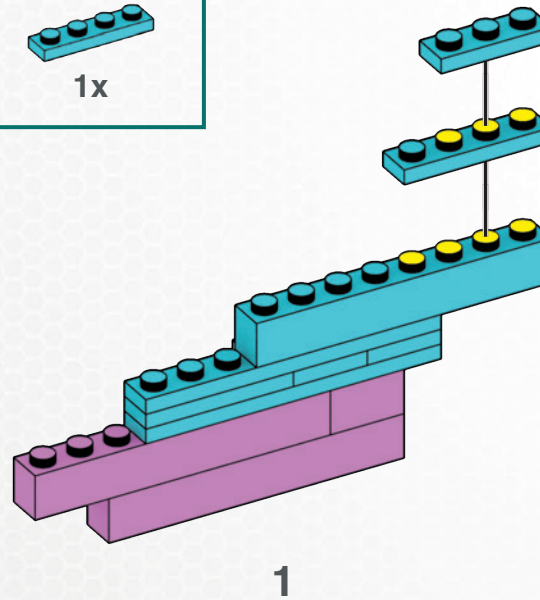
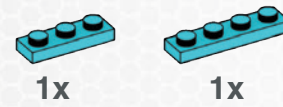

202

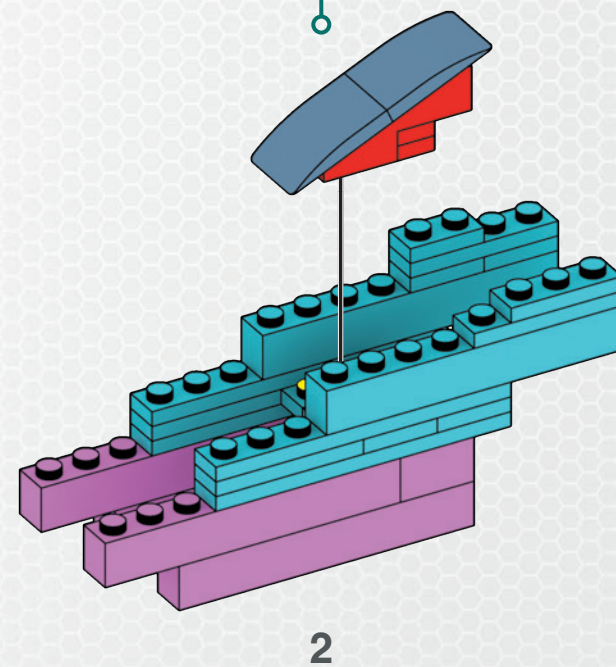
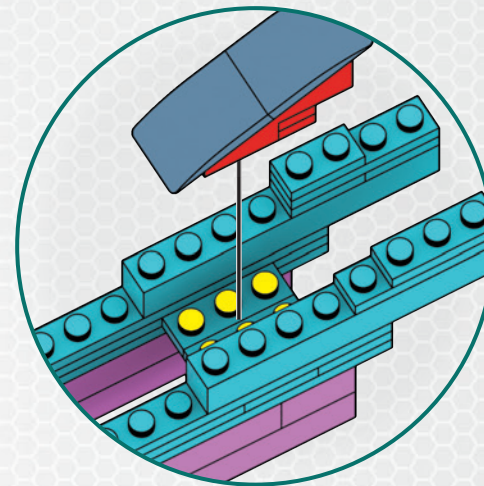
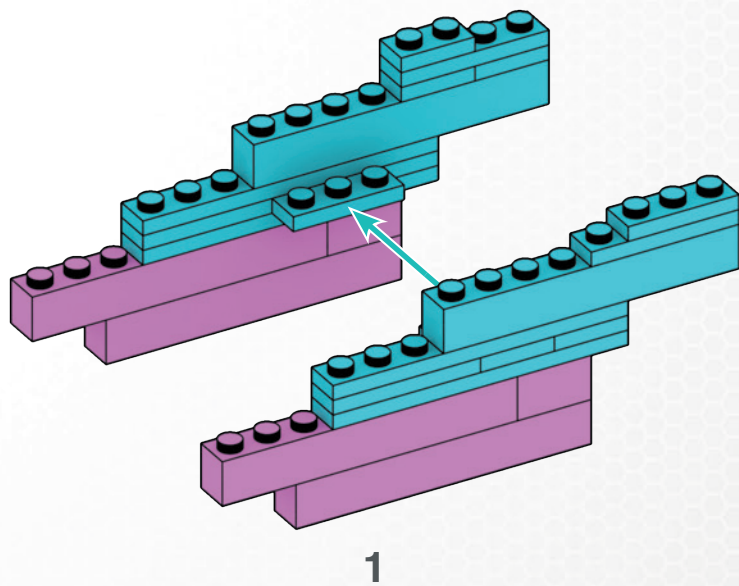
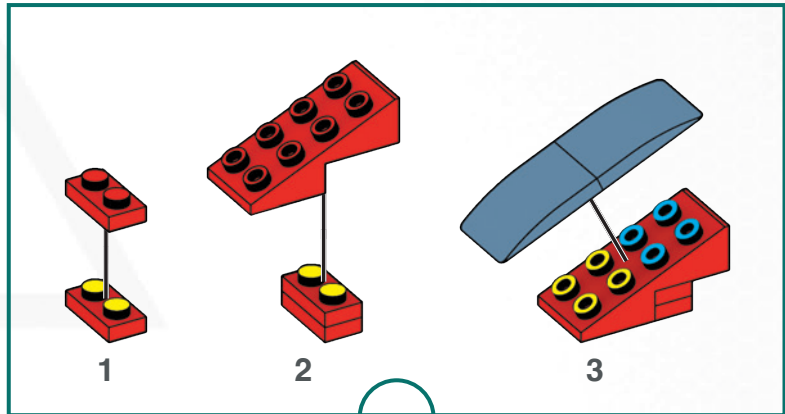
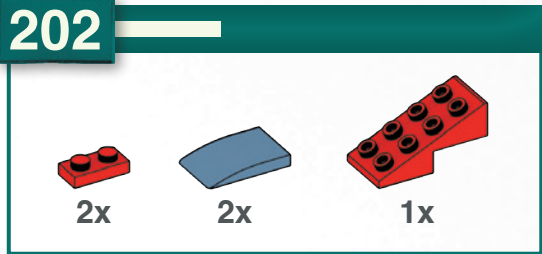

203

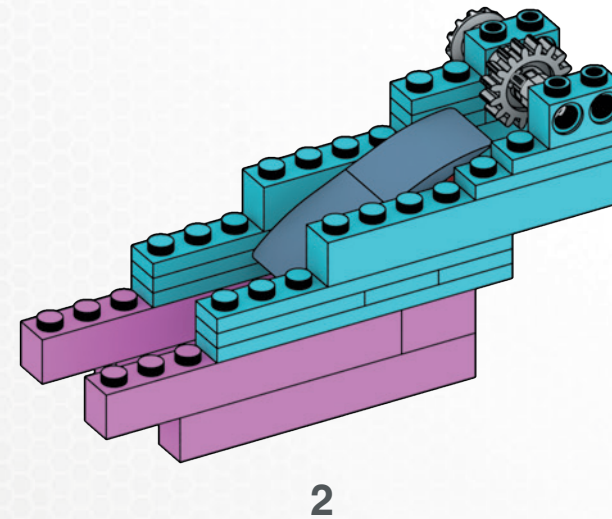
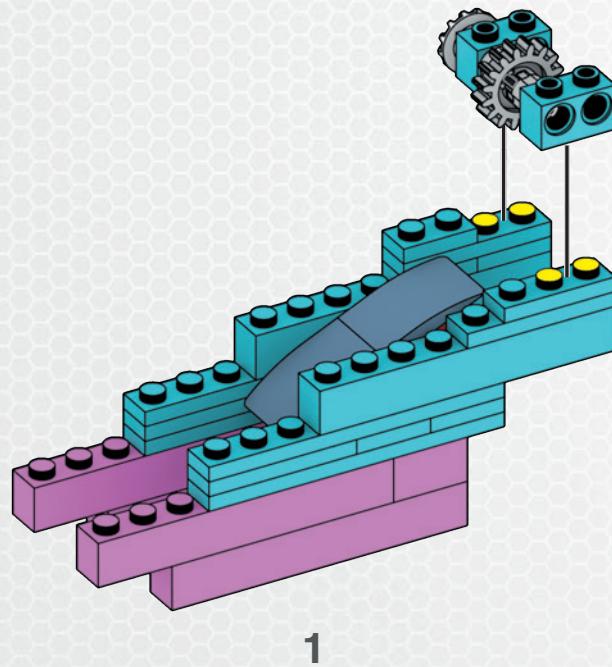
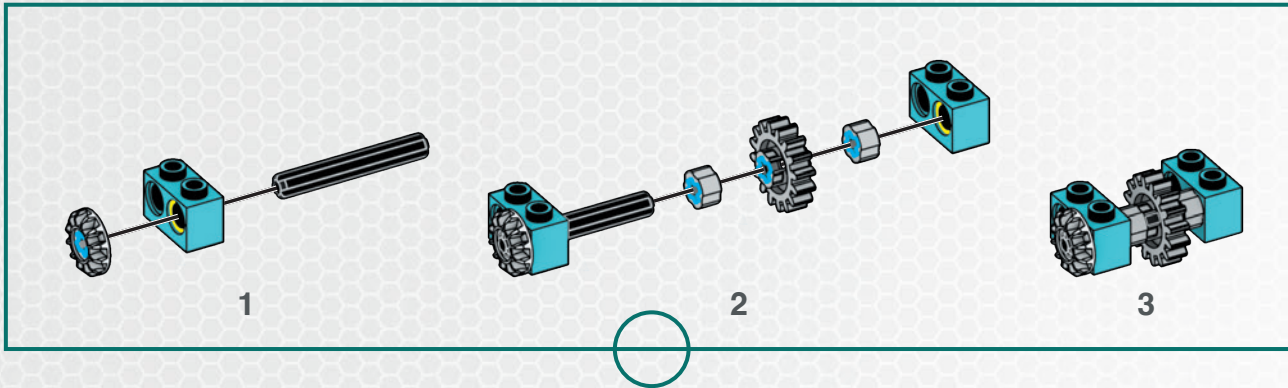

- 1x
- 2x
- 1x
- 1x
- 1x

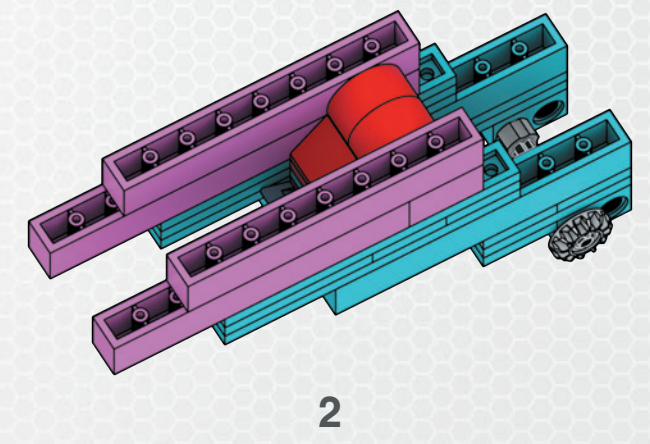
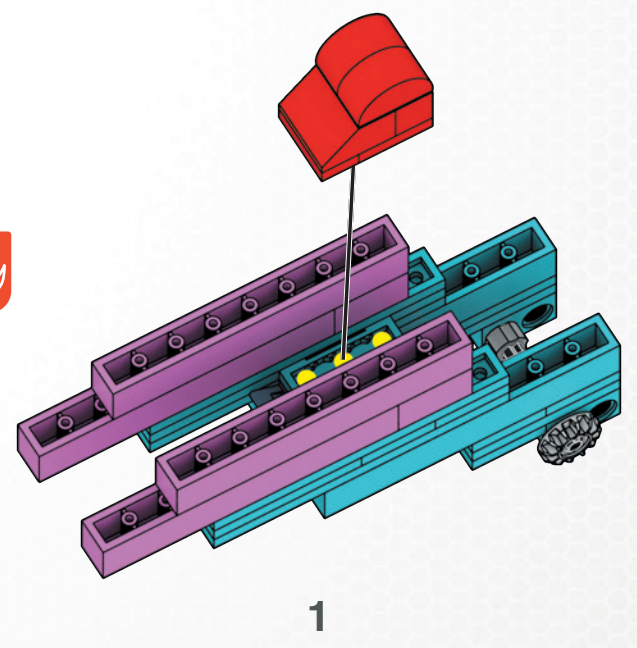
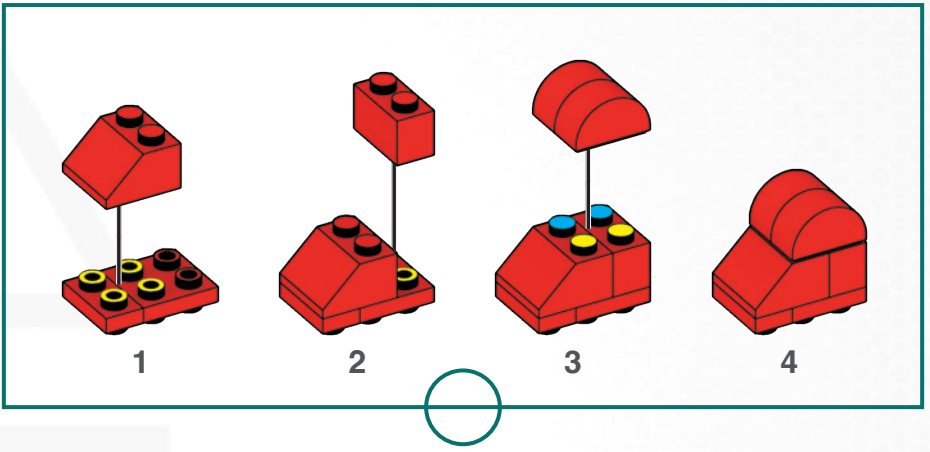

205

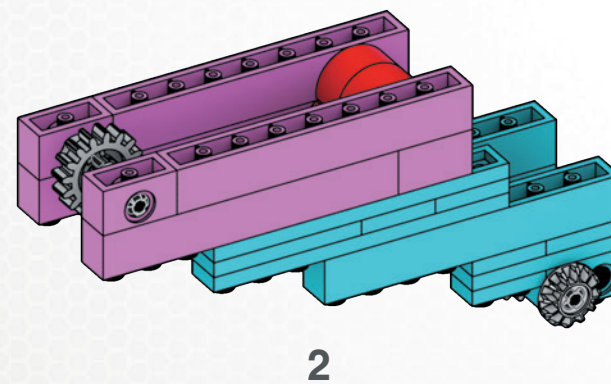
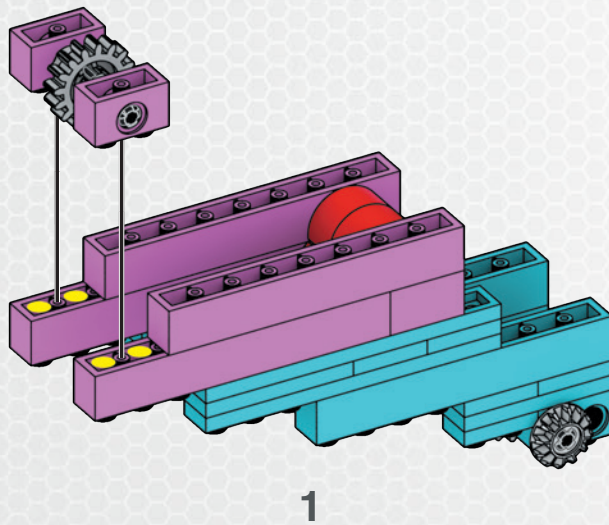
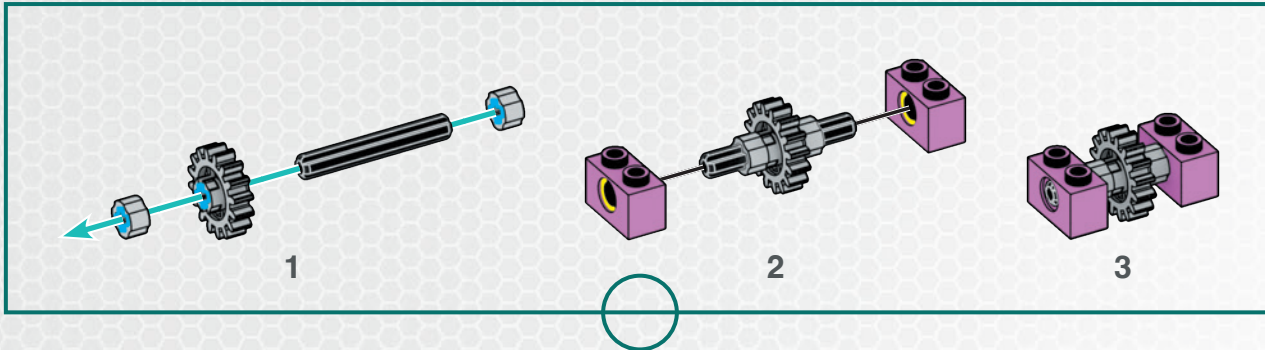

206



28x



14x

x14

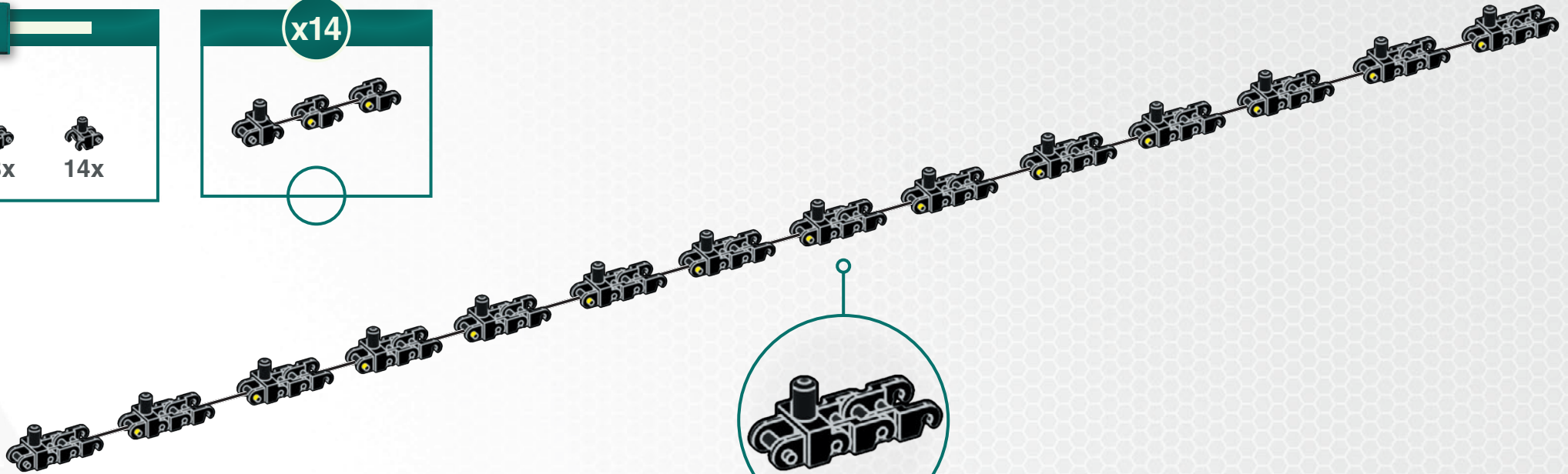

207



14x

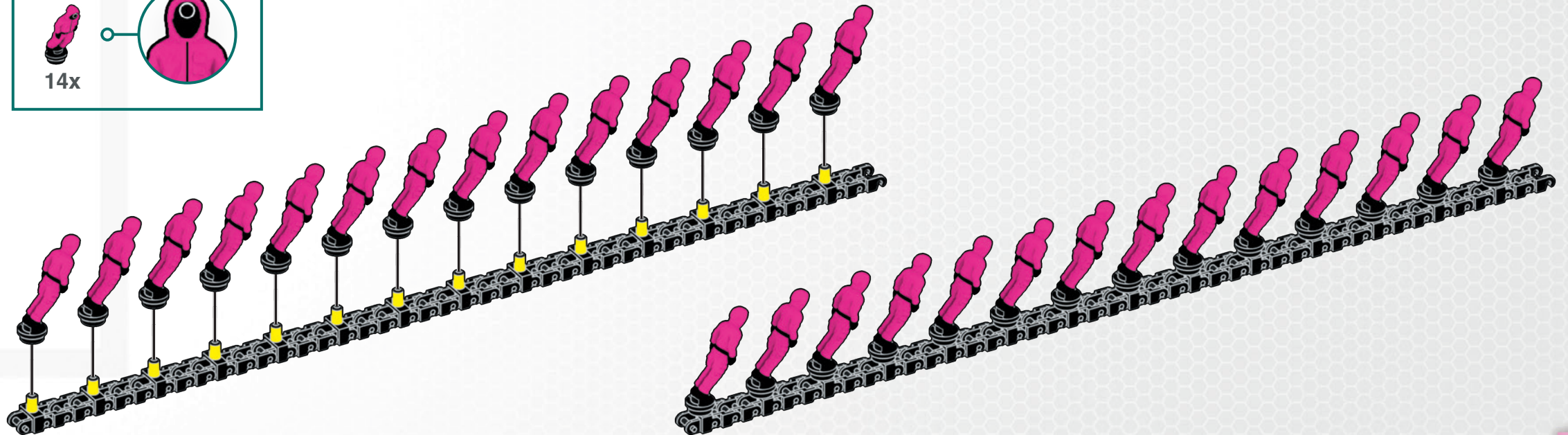

1

2

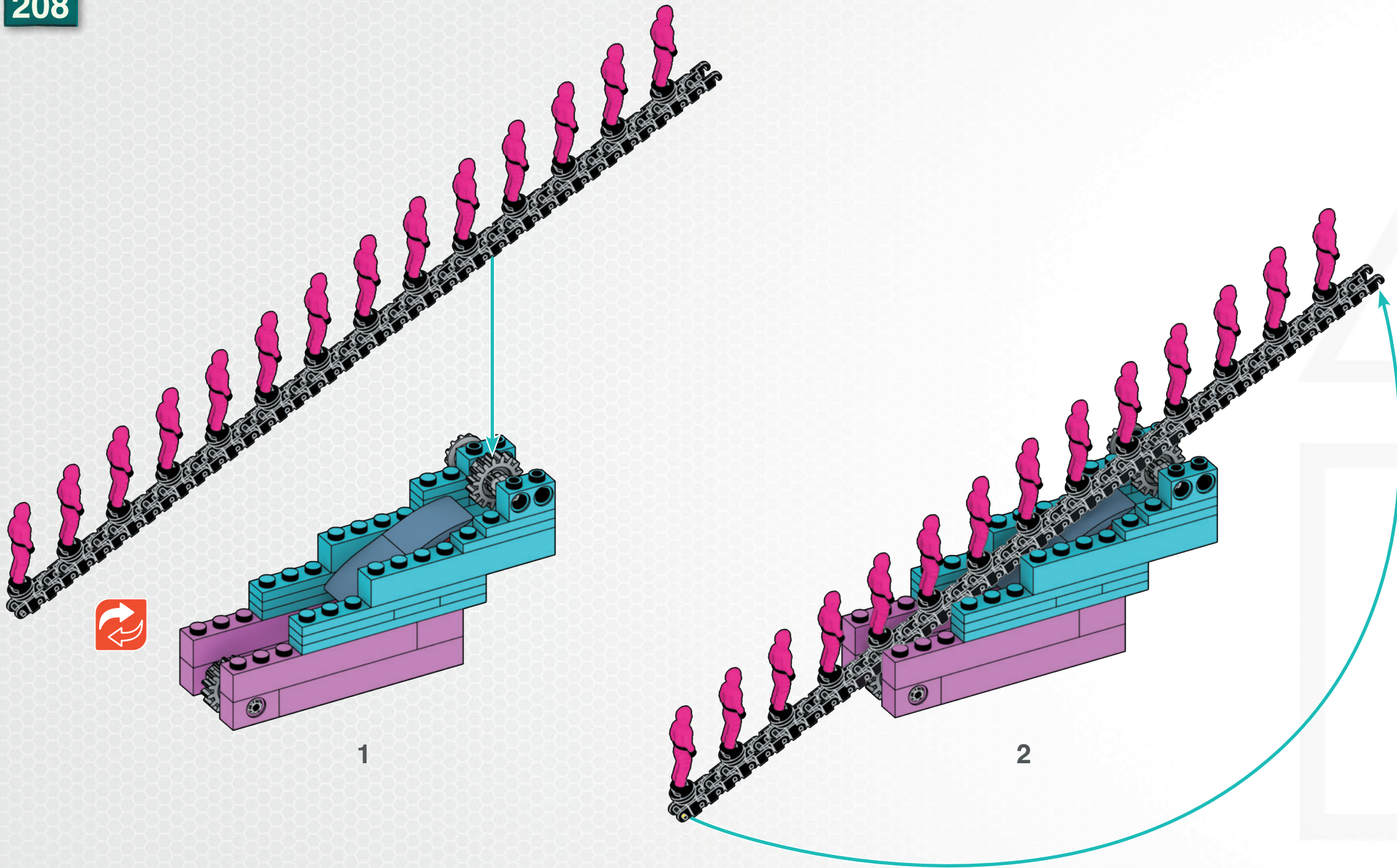

1

2

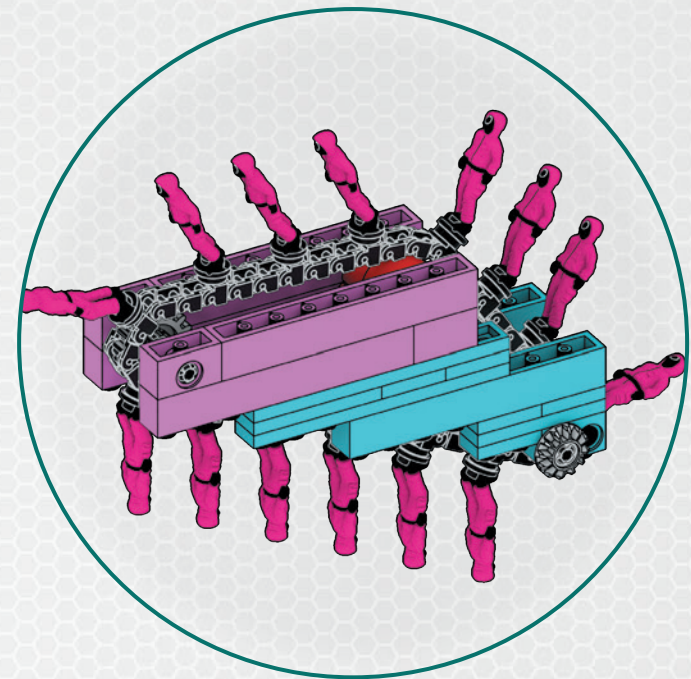
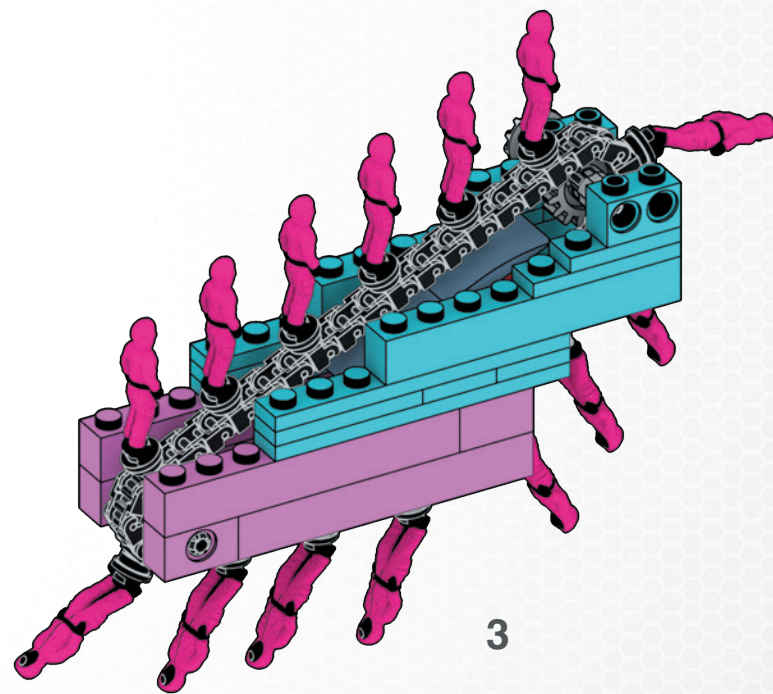

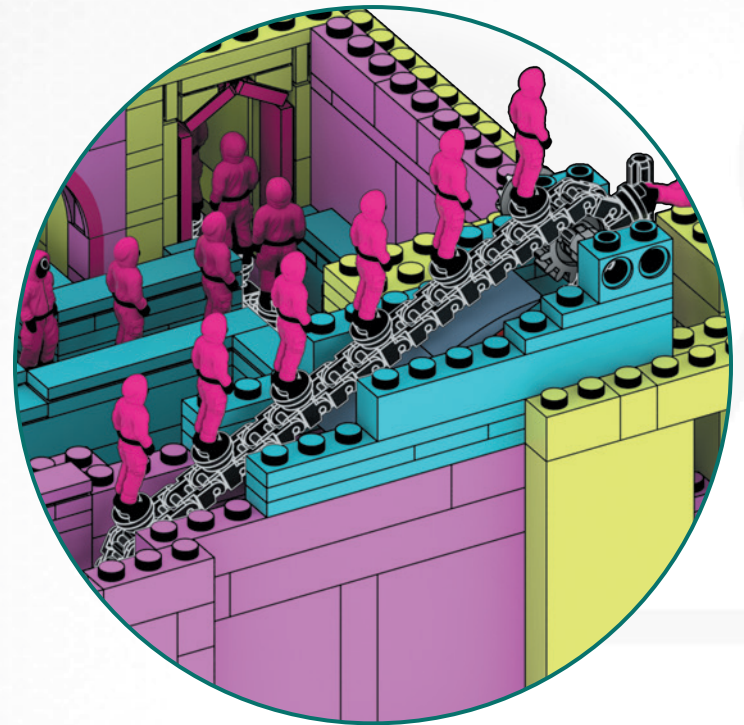
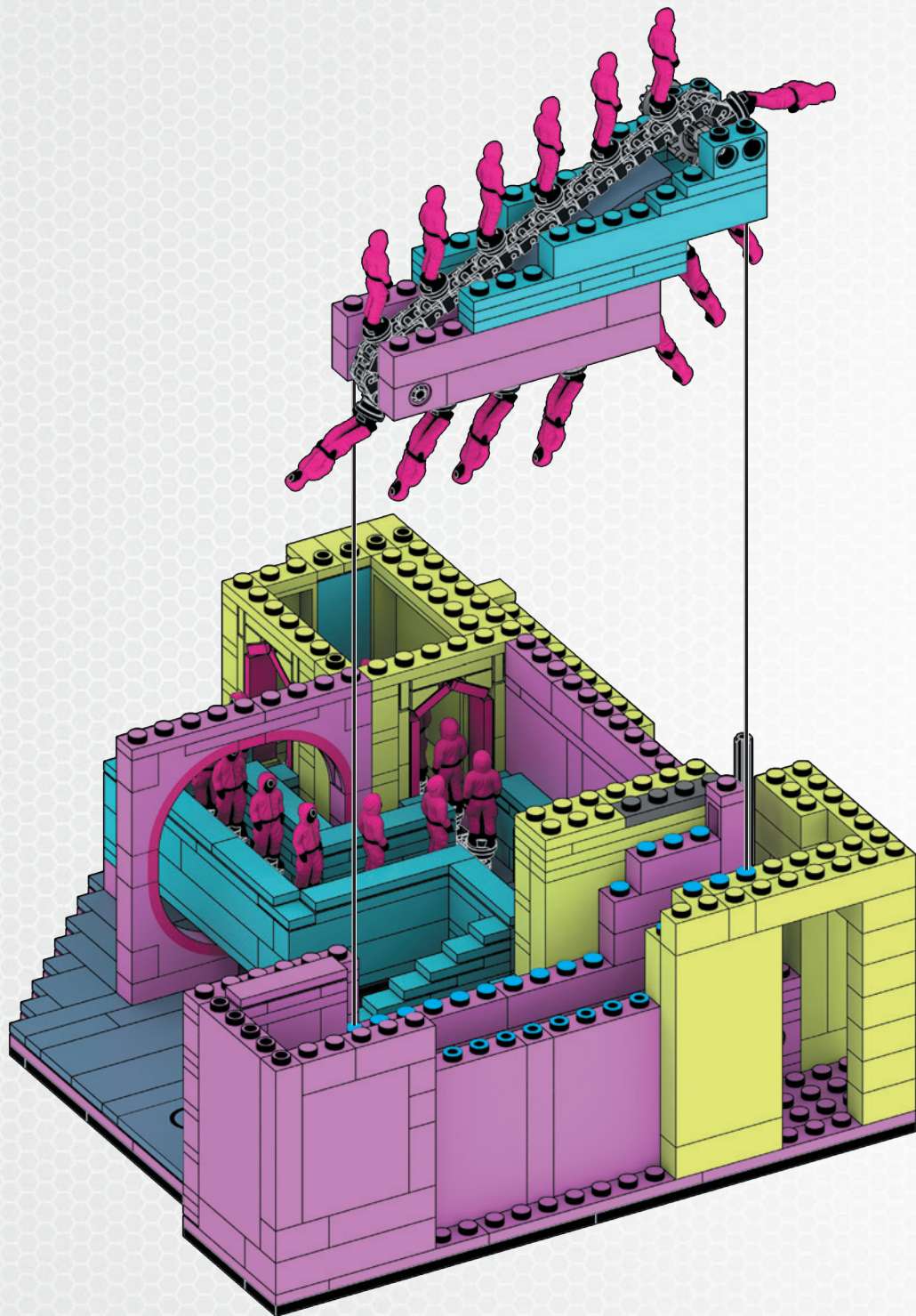

210

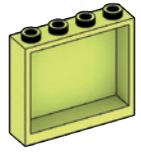

1x

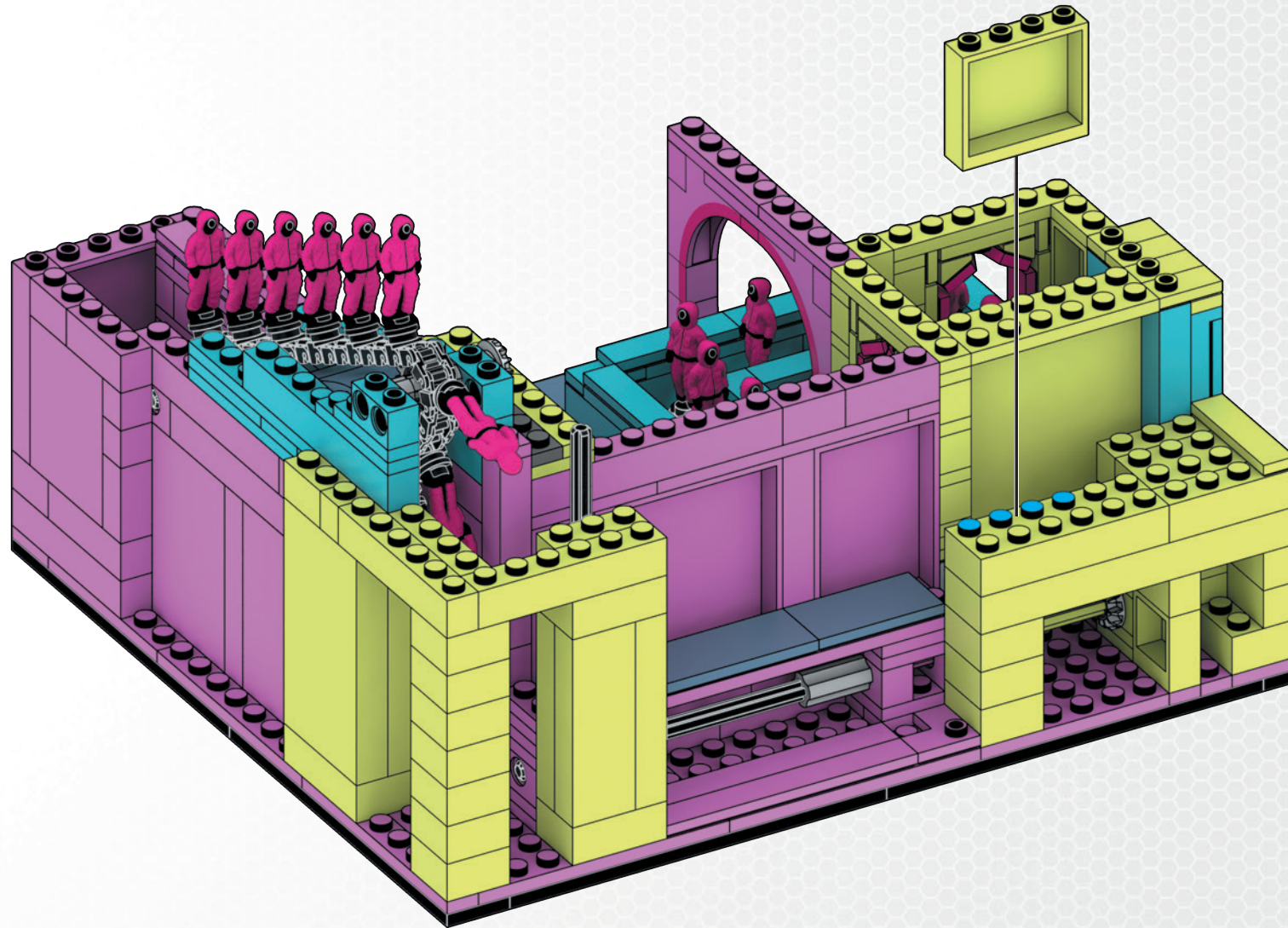

211

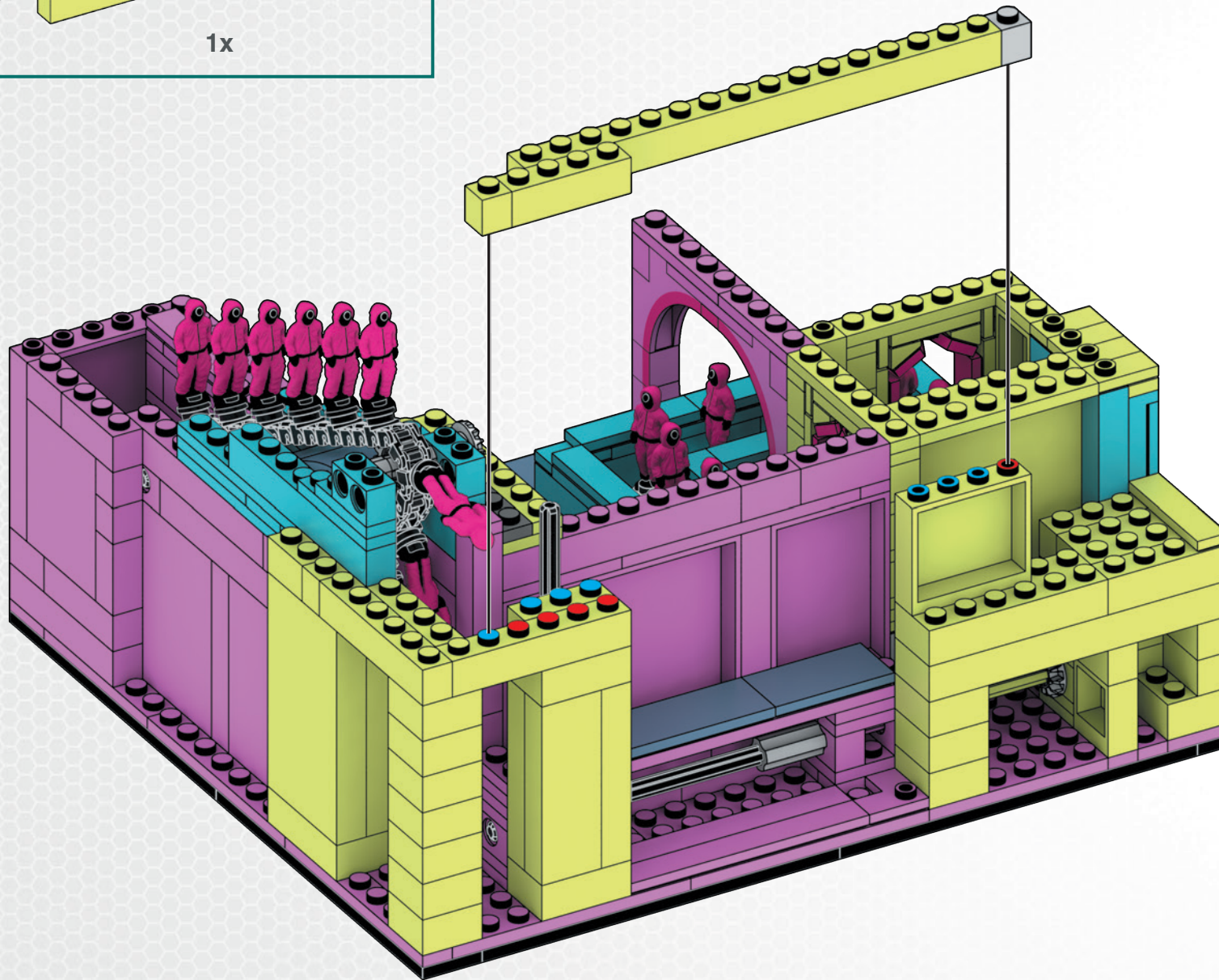
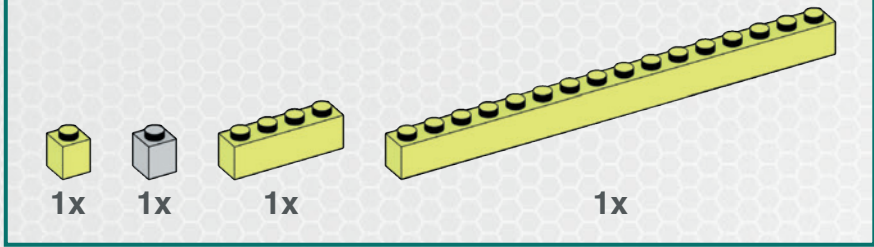

212

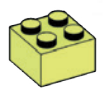

1x

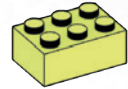

1x

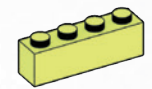

1x

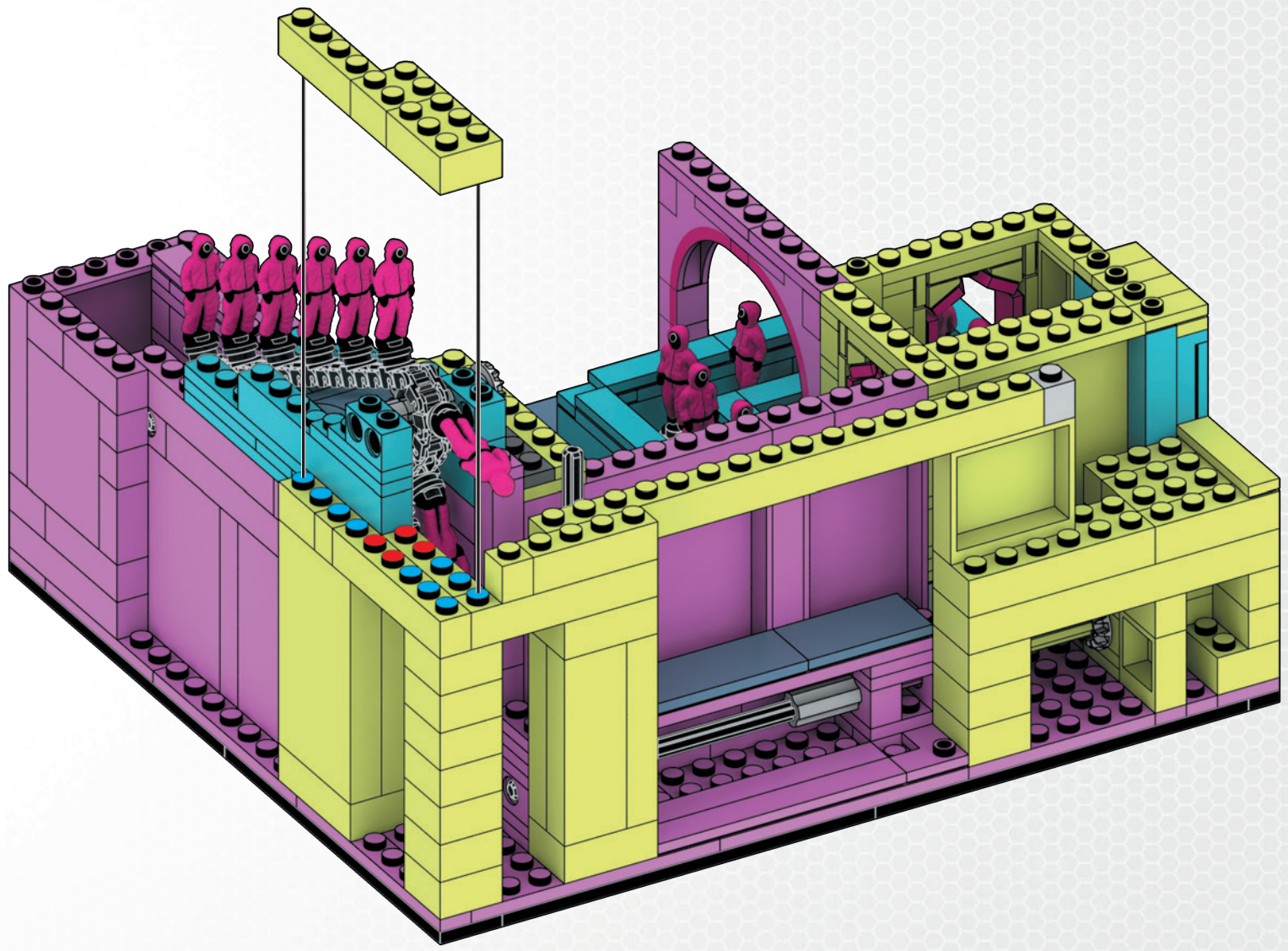

213



2x

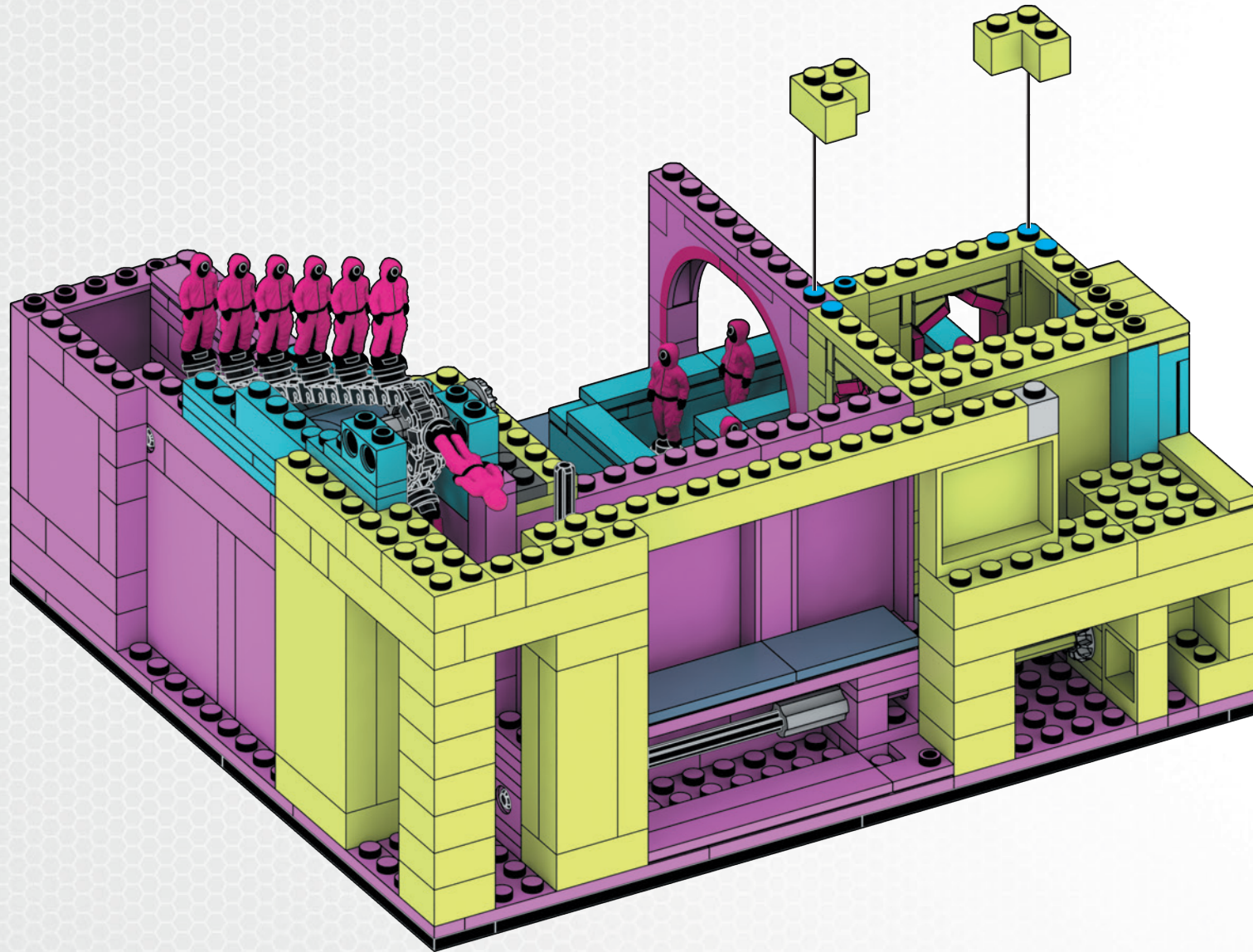

214

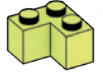

2x

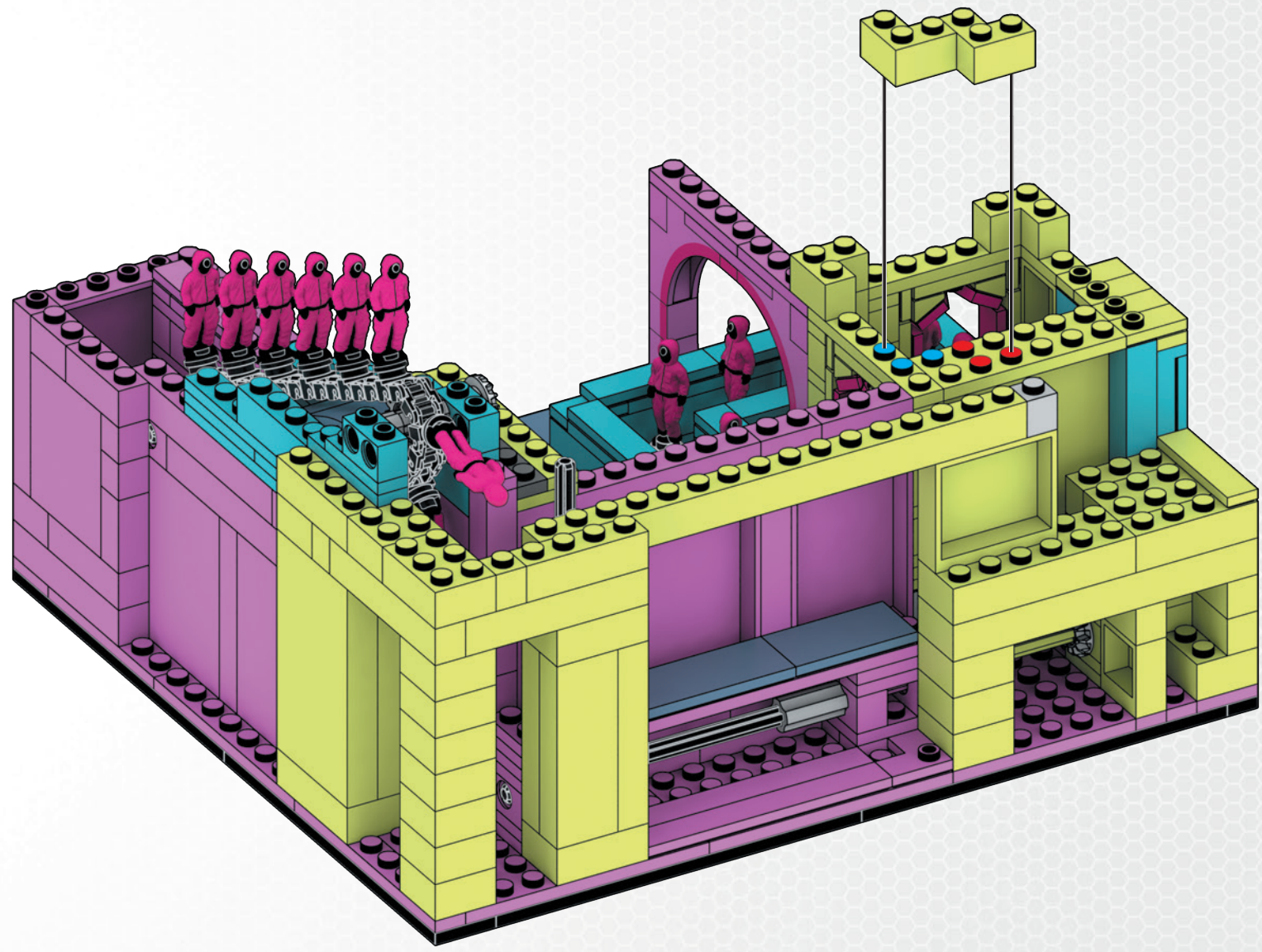

215

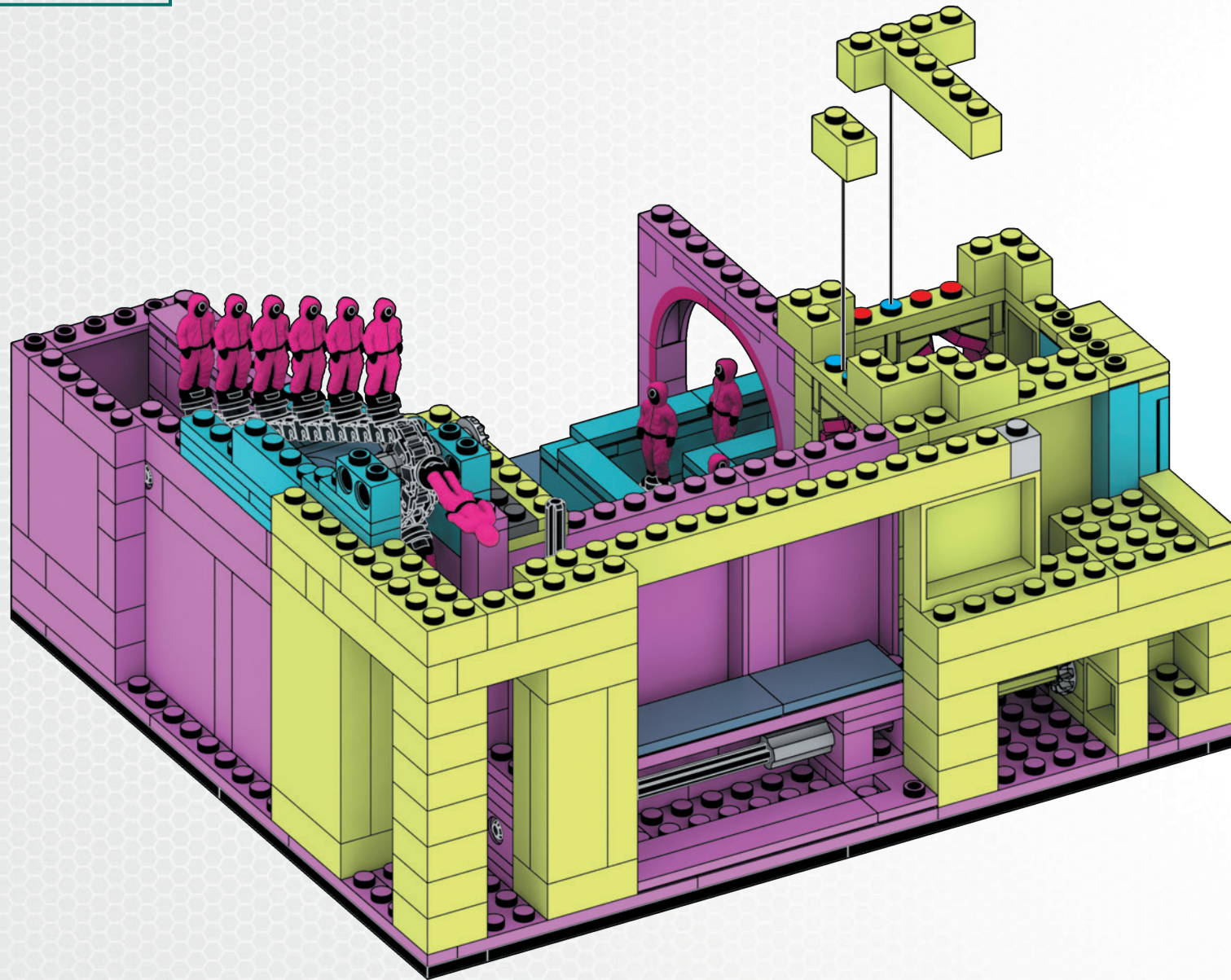
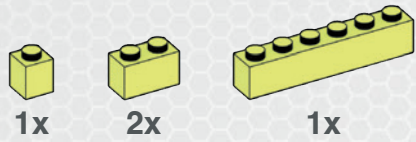

216

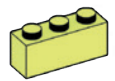

1x

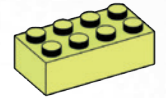

1x

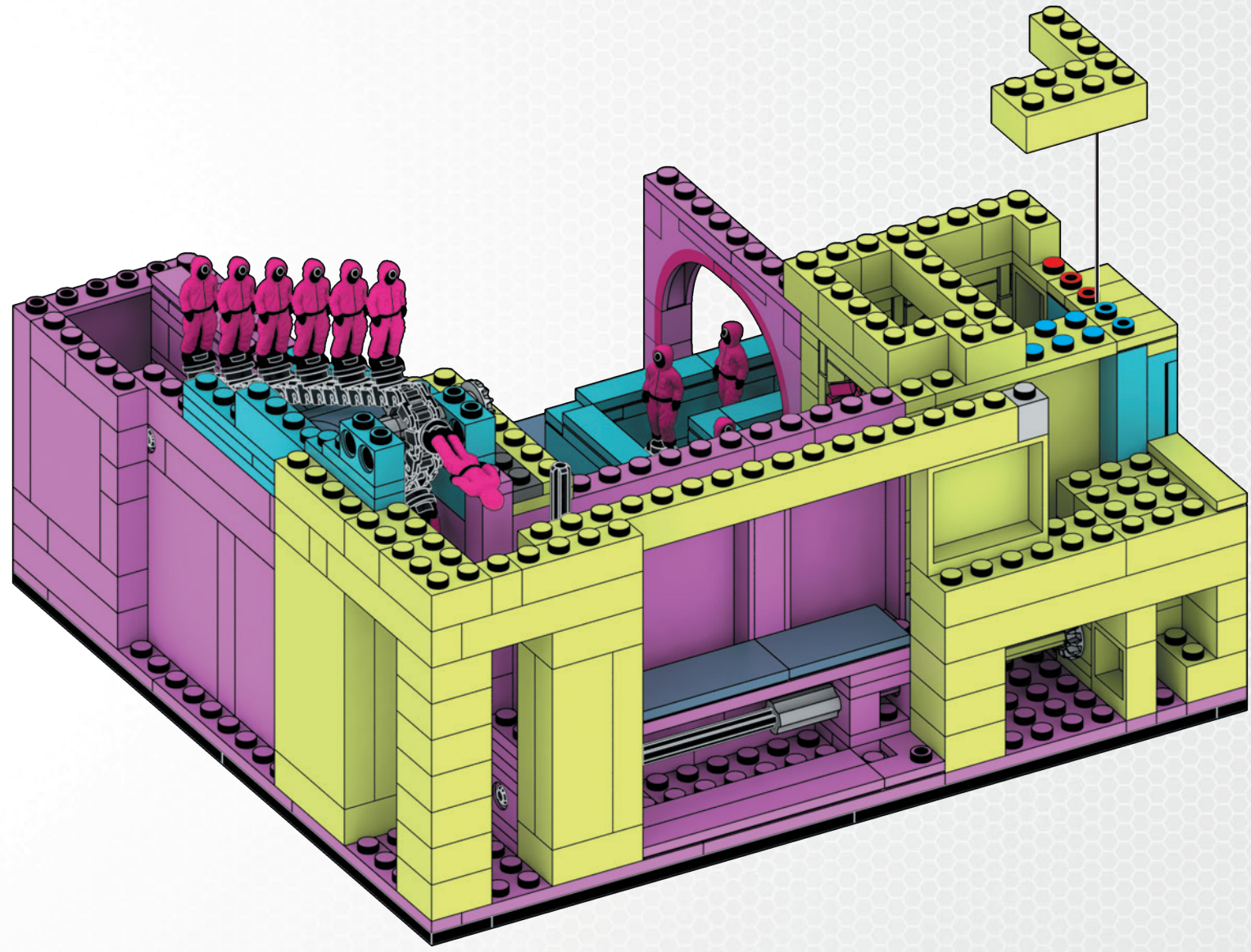

217



1x

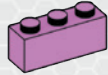

1x

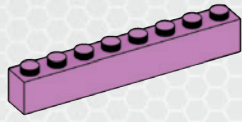

2x

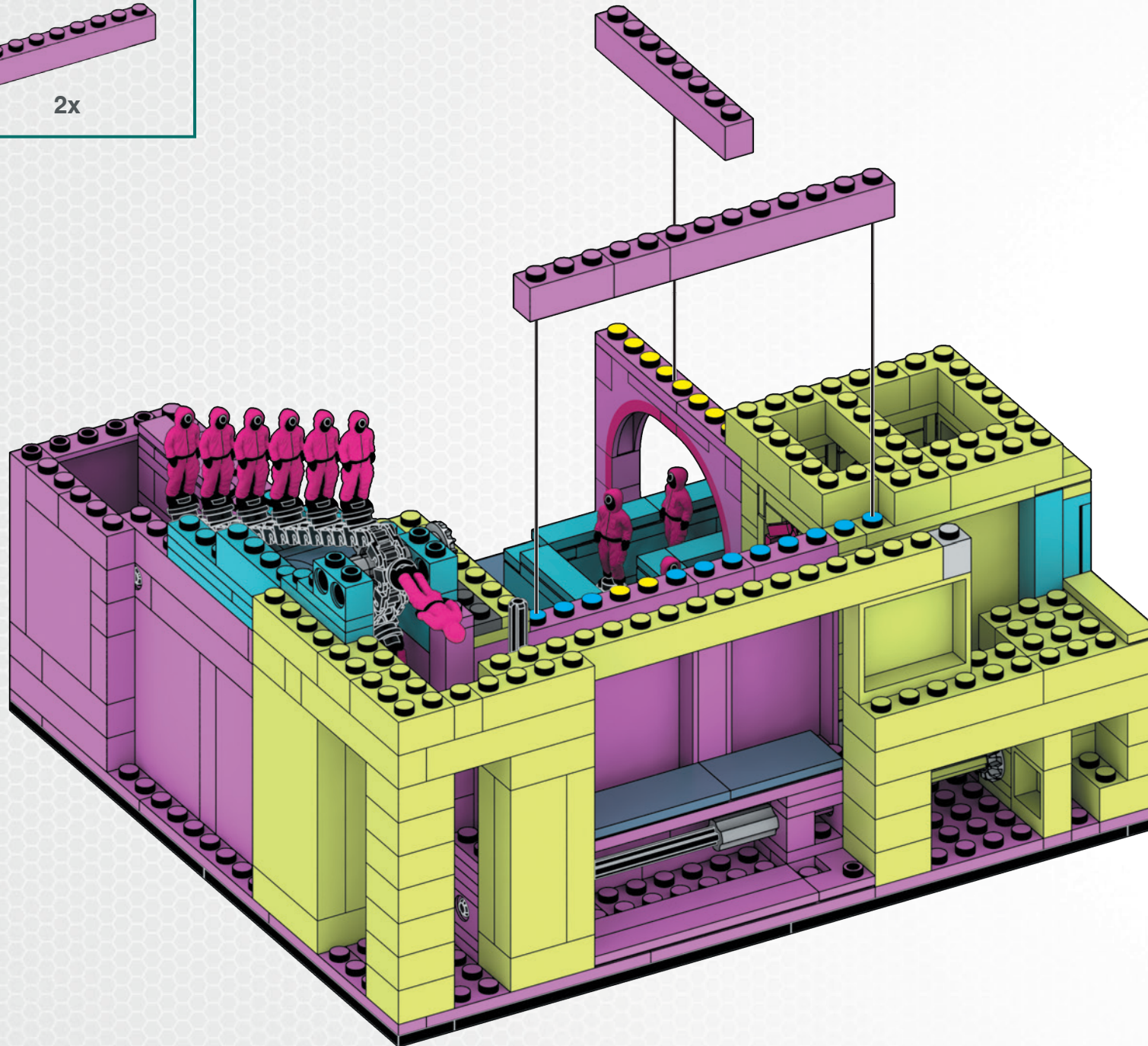

218



1x

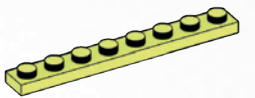

1x

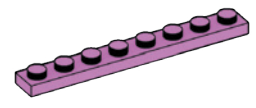

1x

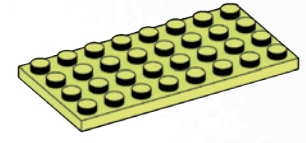

1x

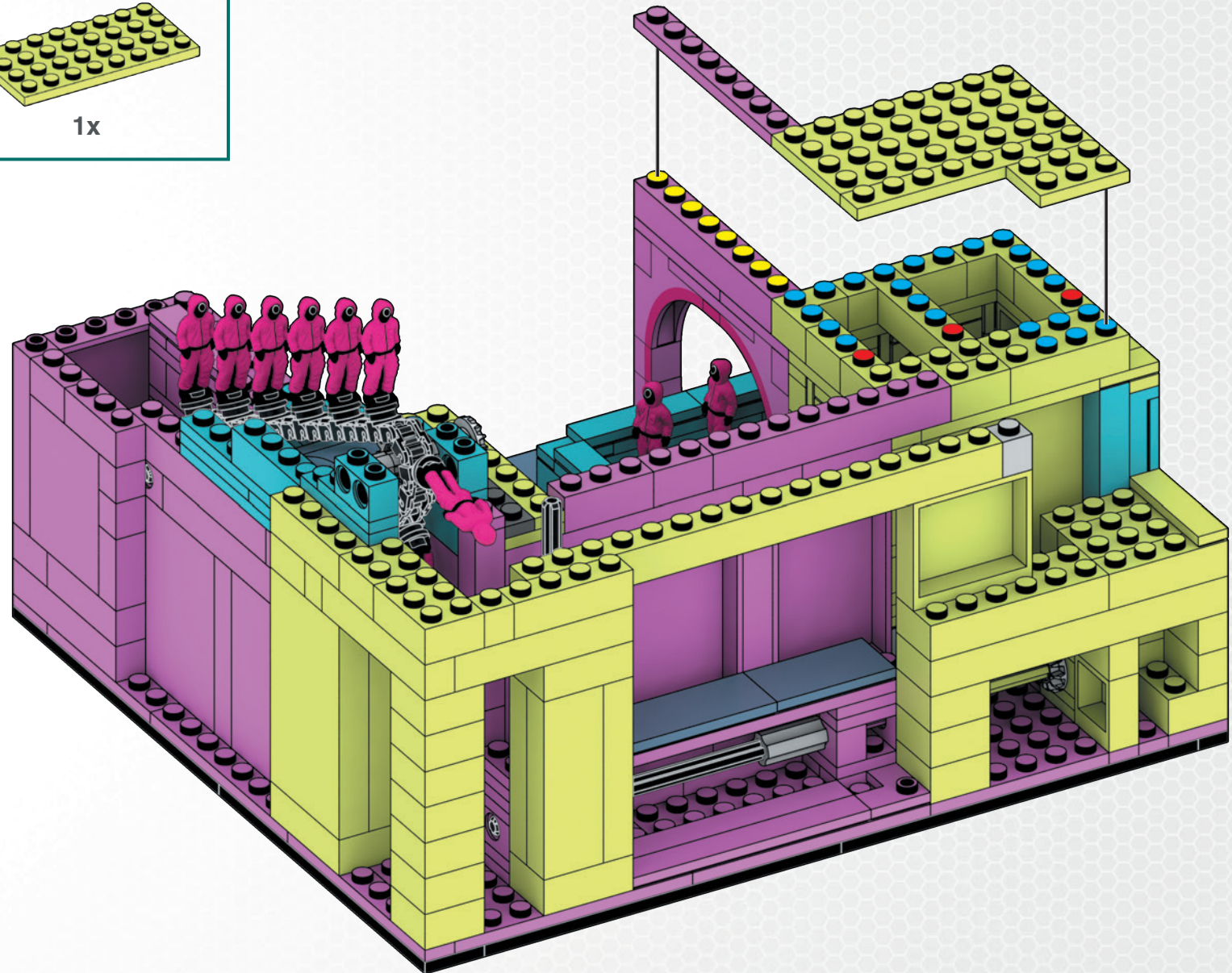

219



1x



1x



1x

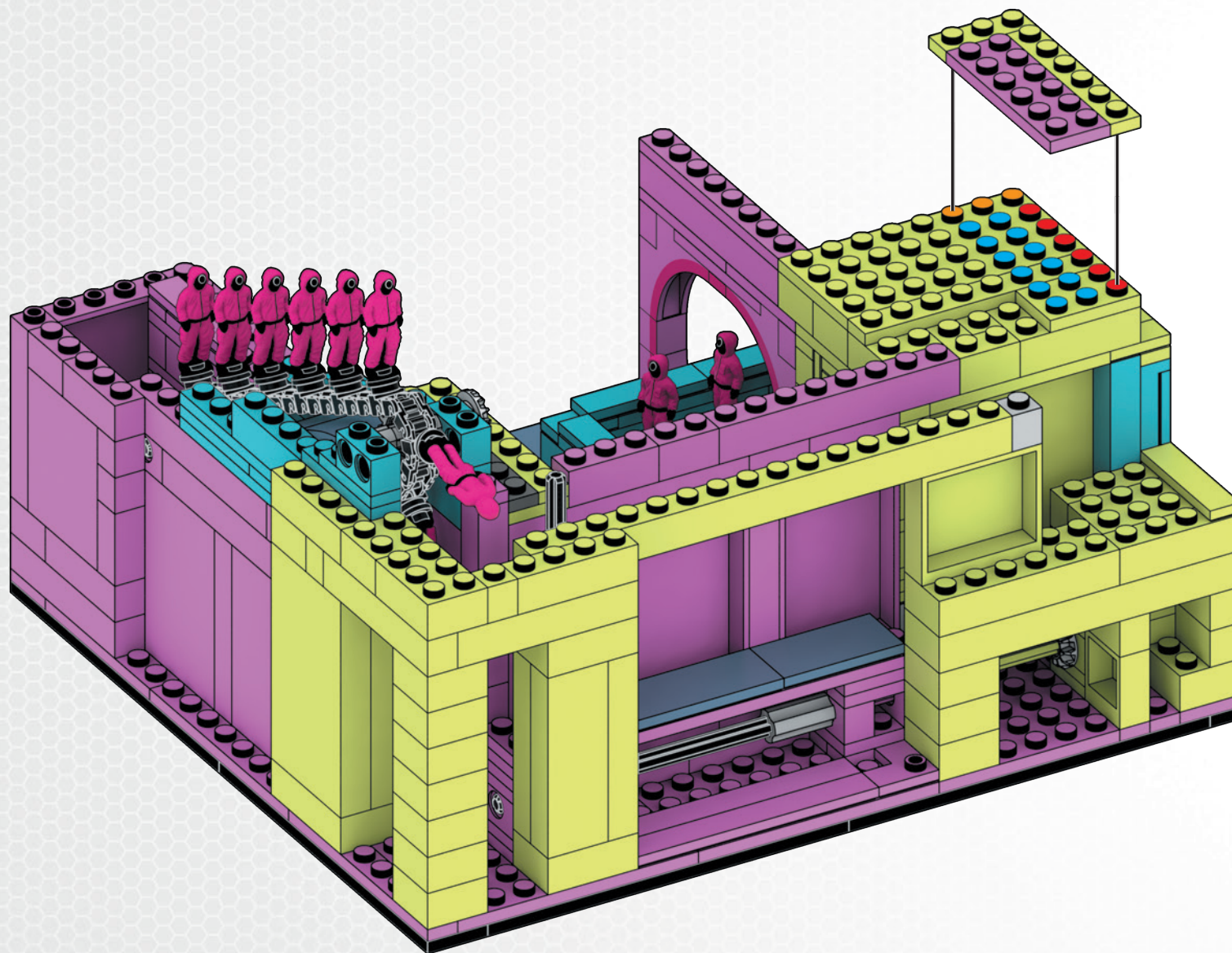

220

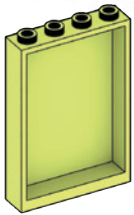

2x

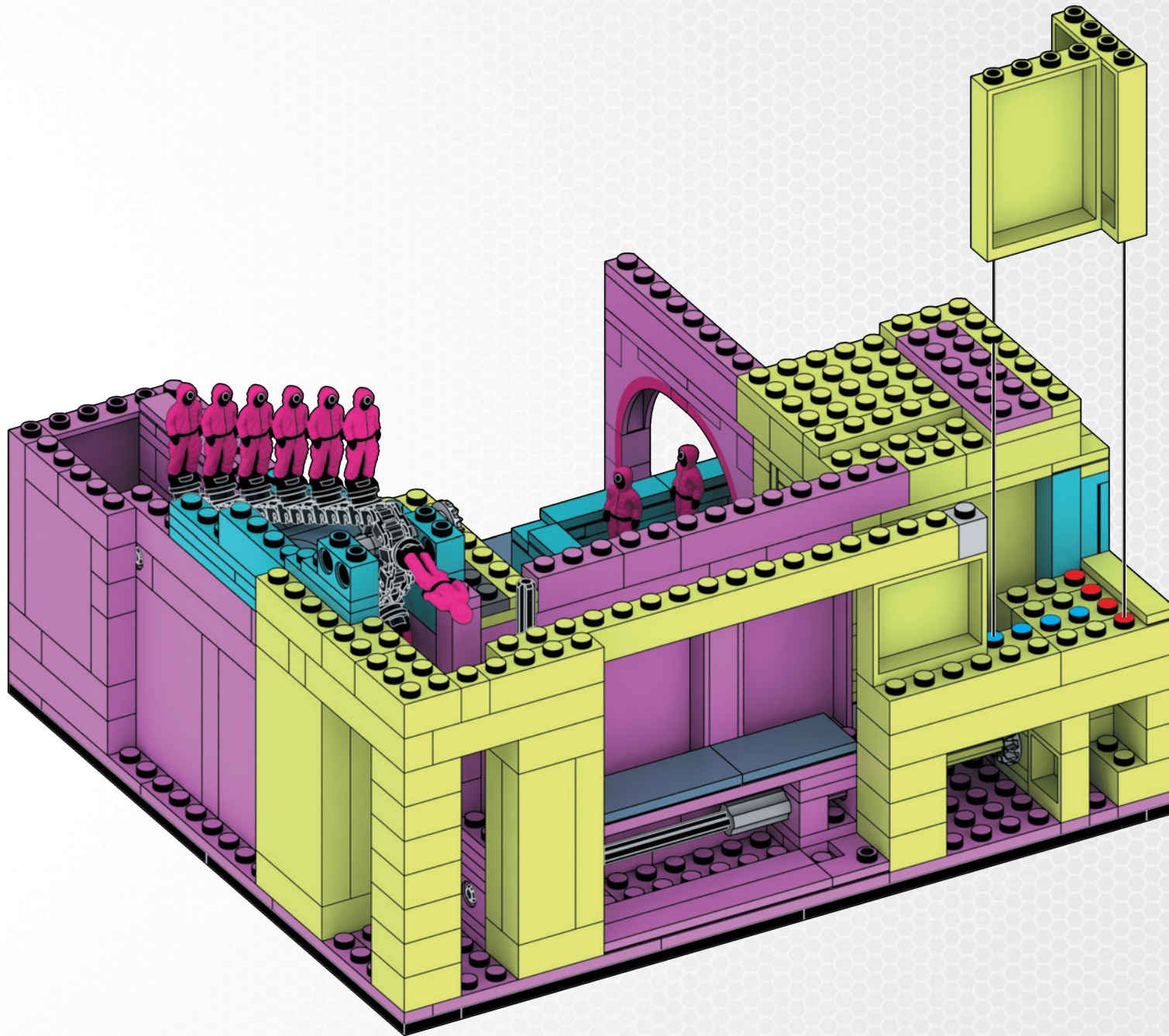

221

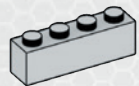

1x

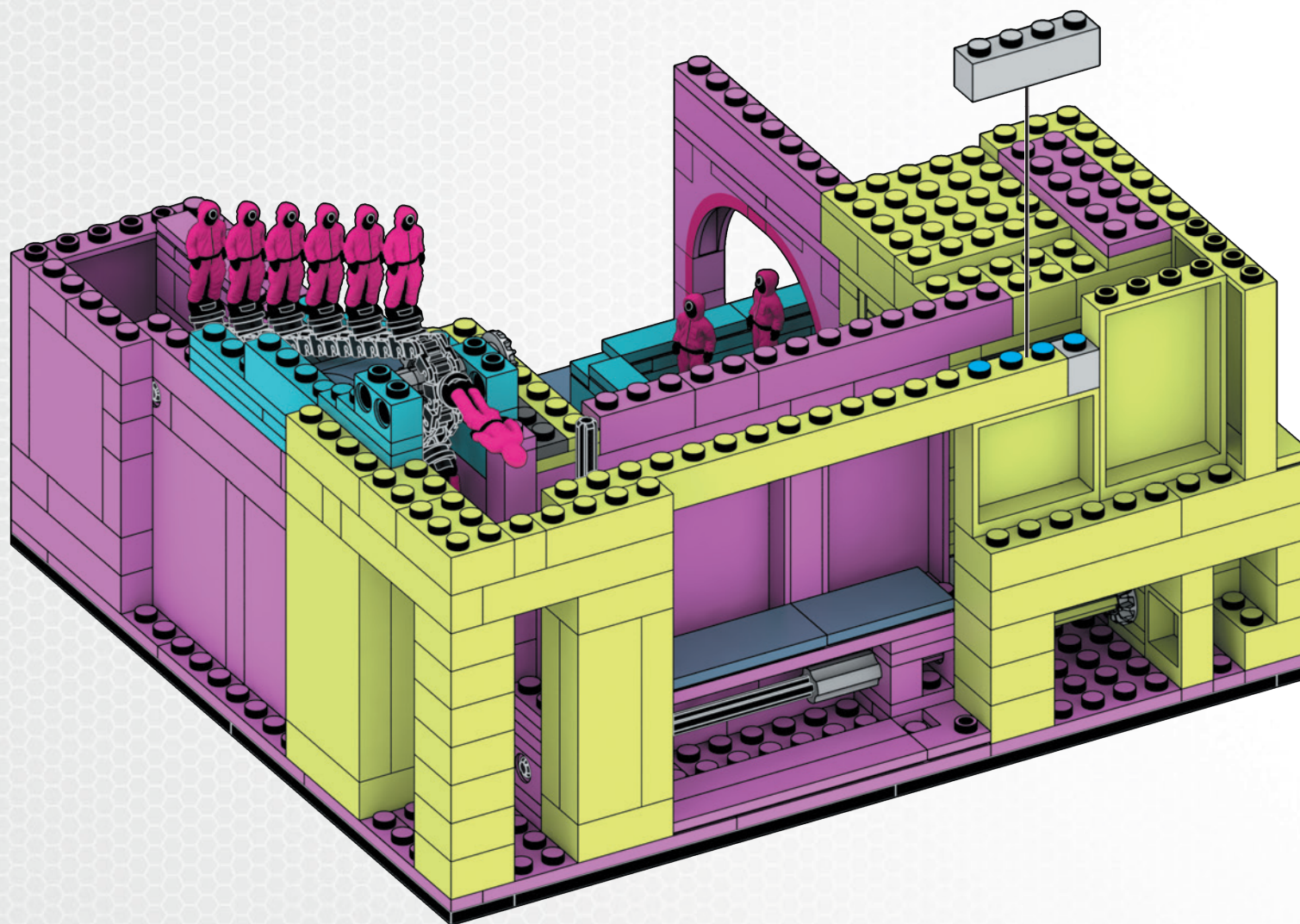

222



1x

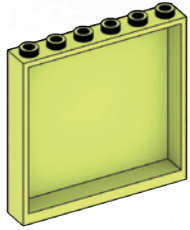

1x

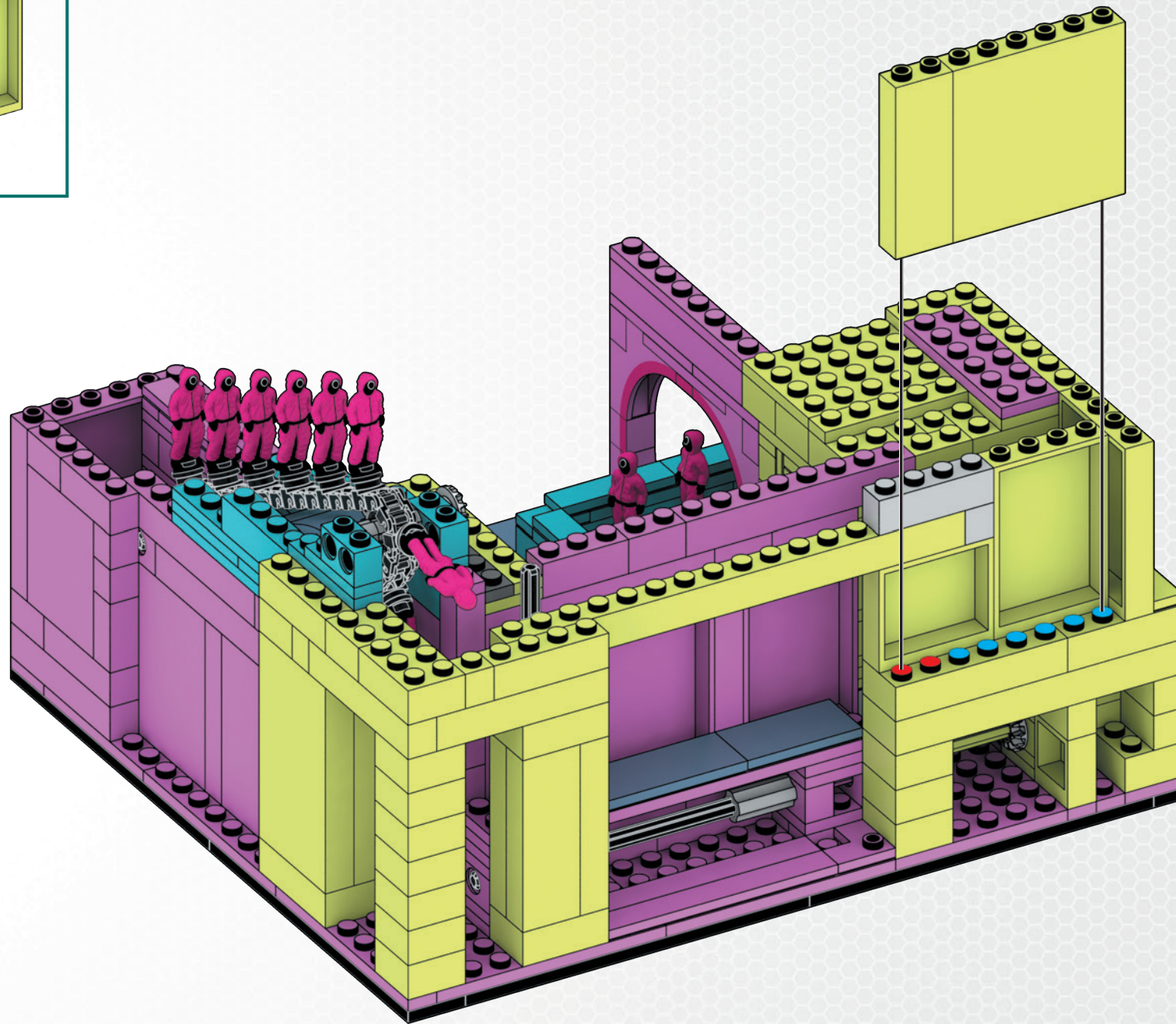

223

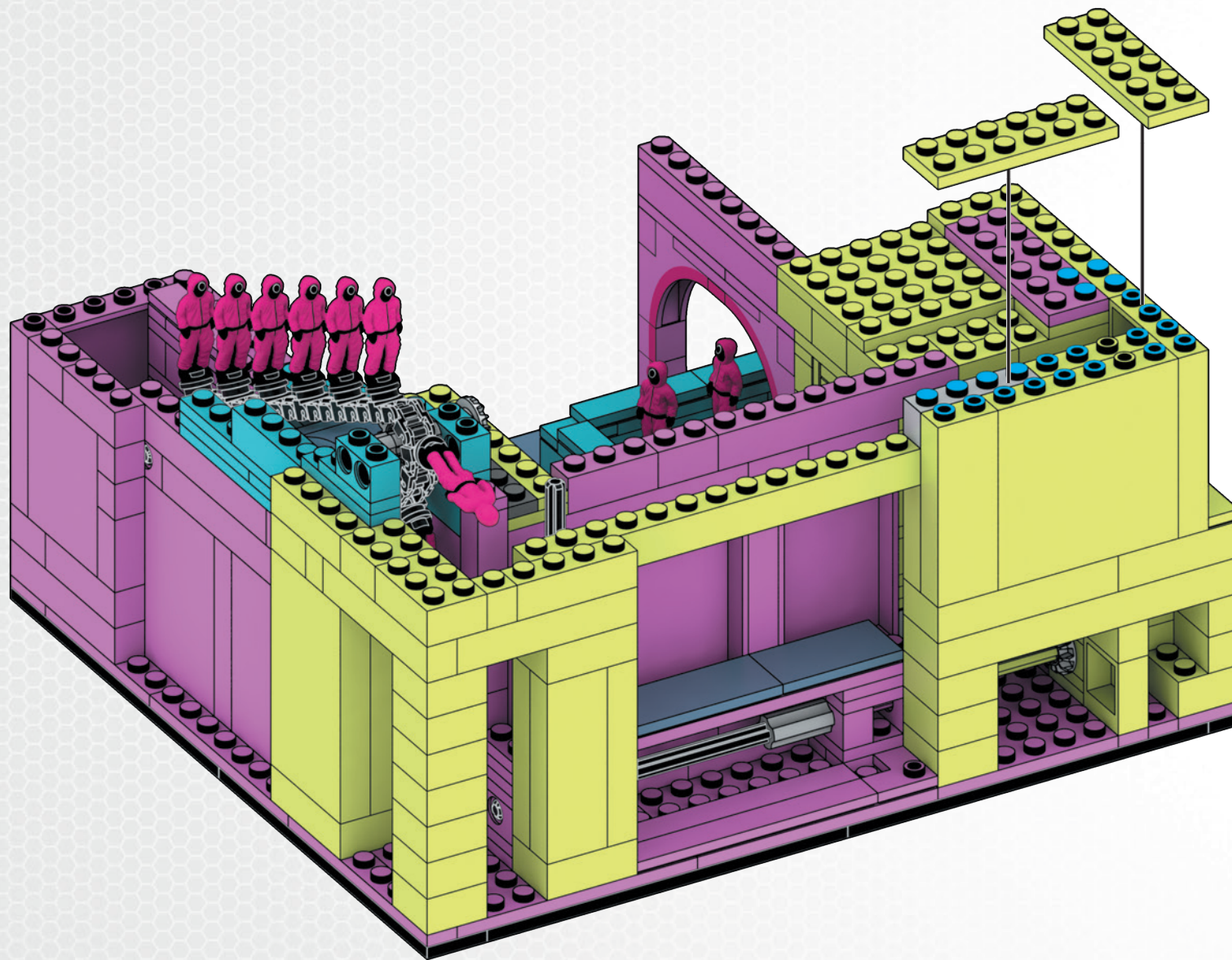
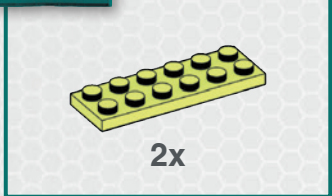



224

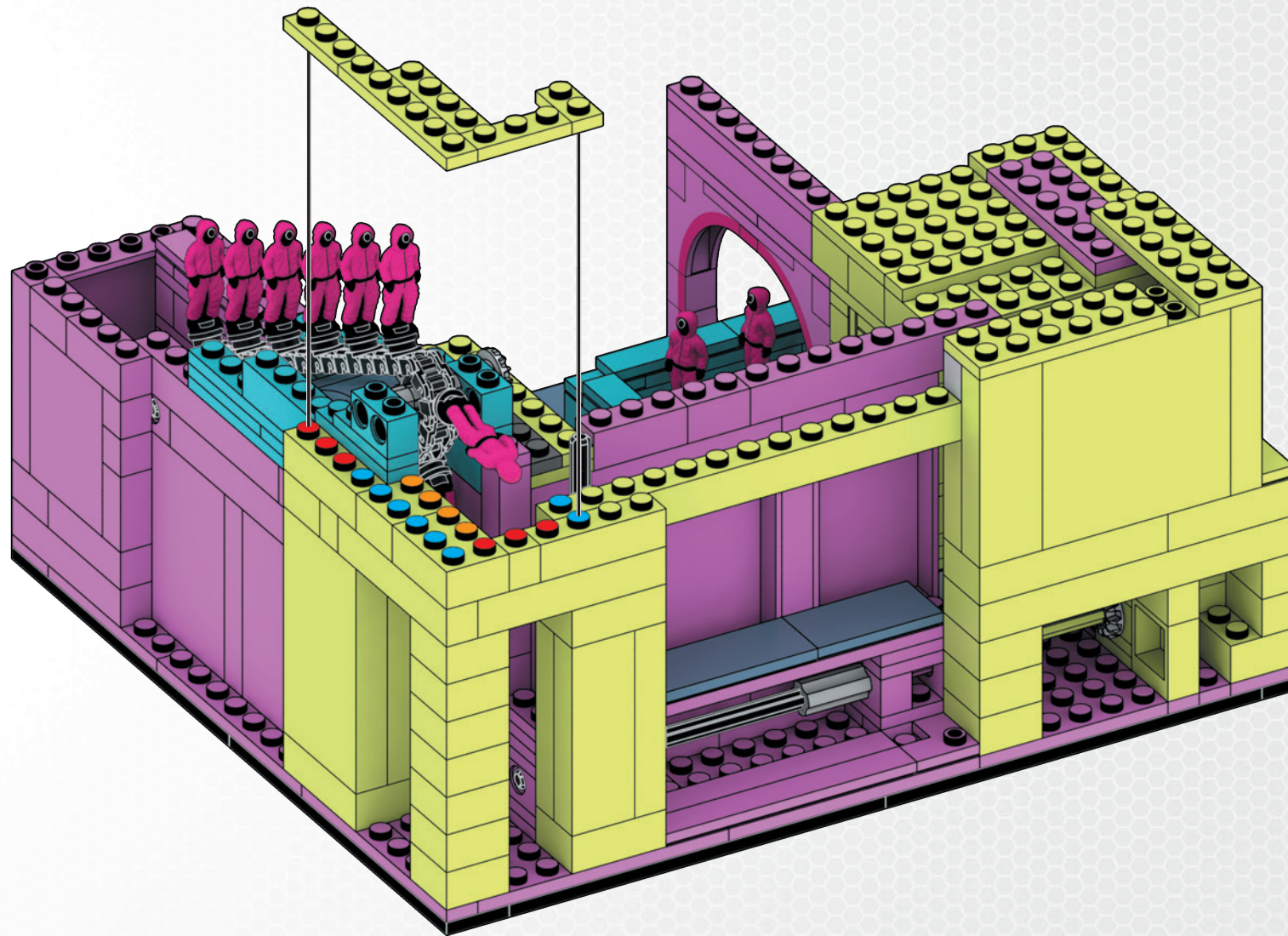
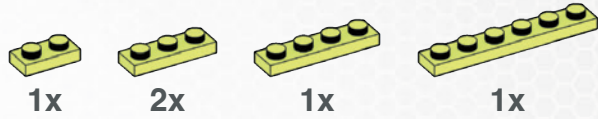

225

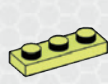

1x



1x

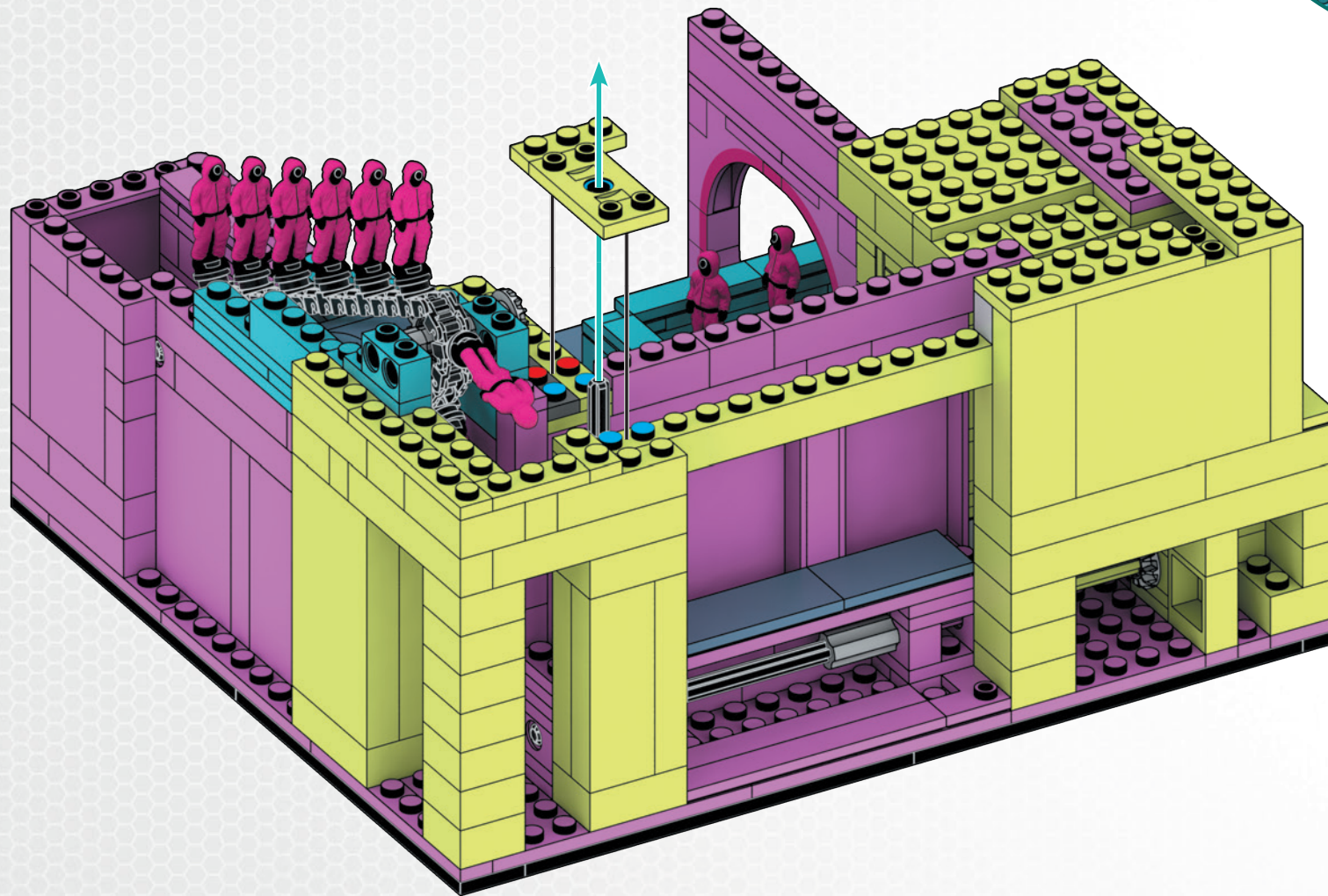
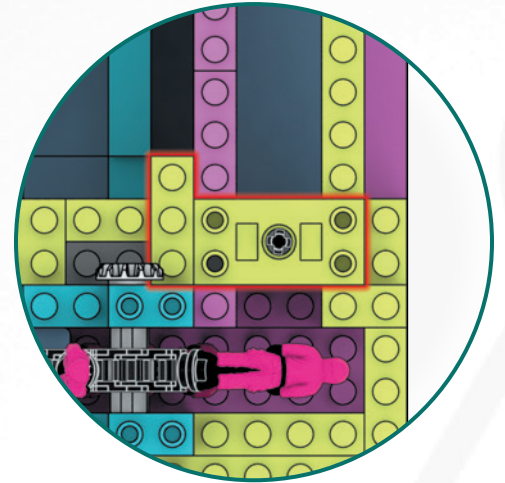

226



1x

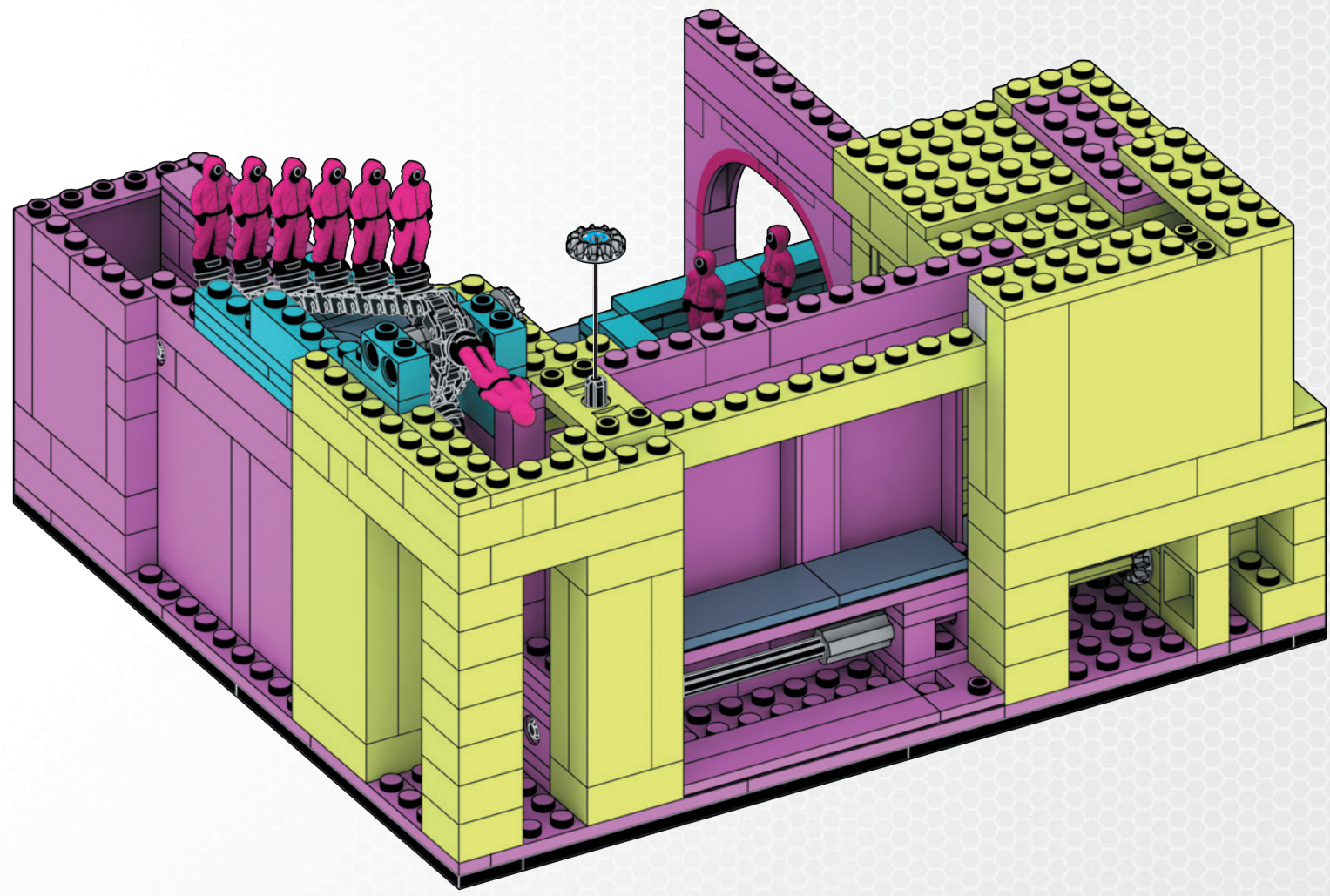

227



1x



1x



1x

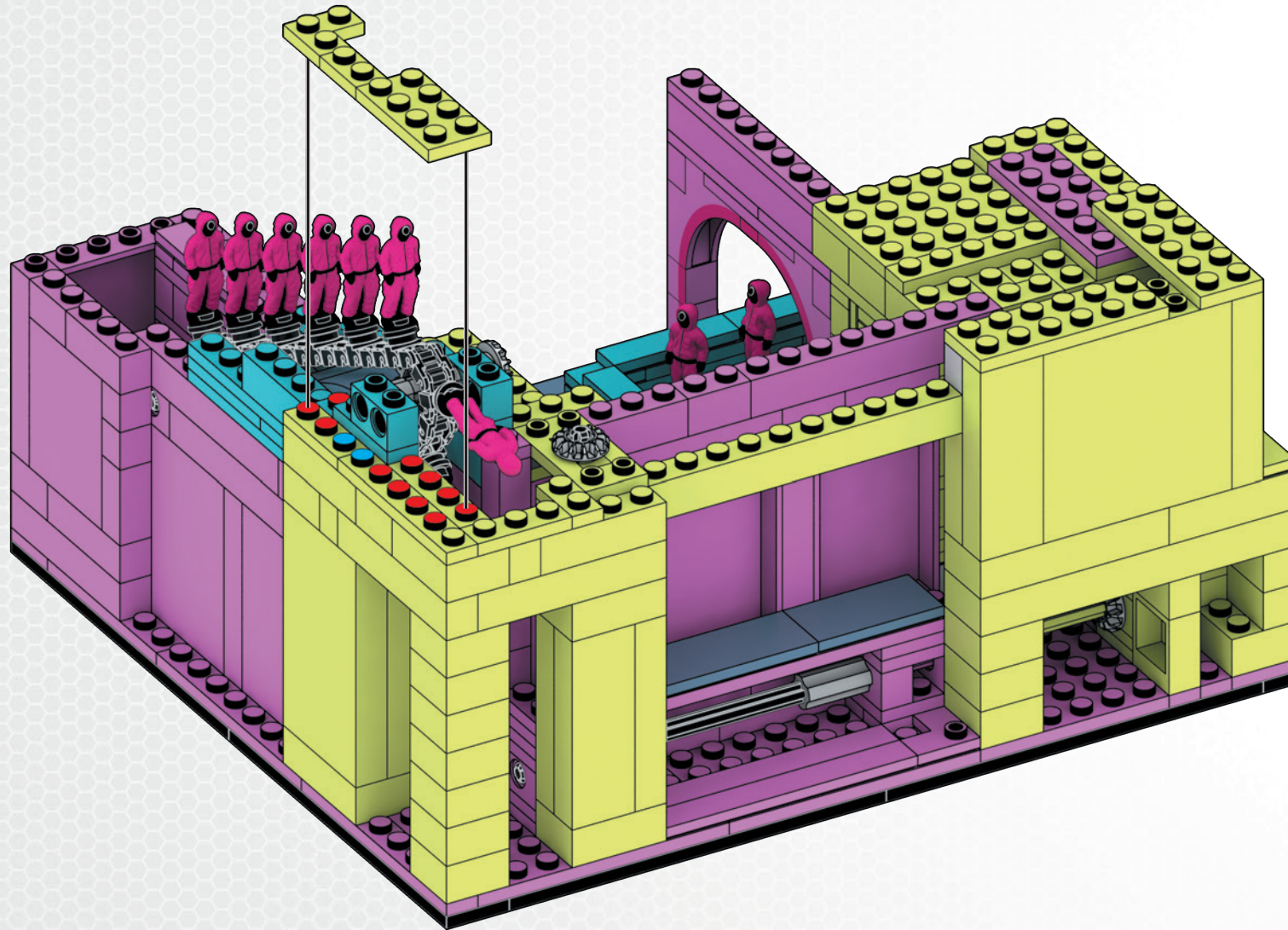

228

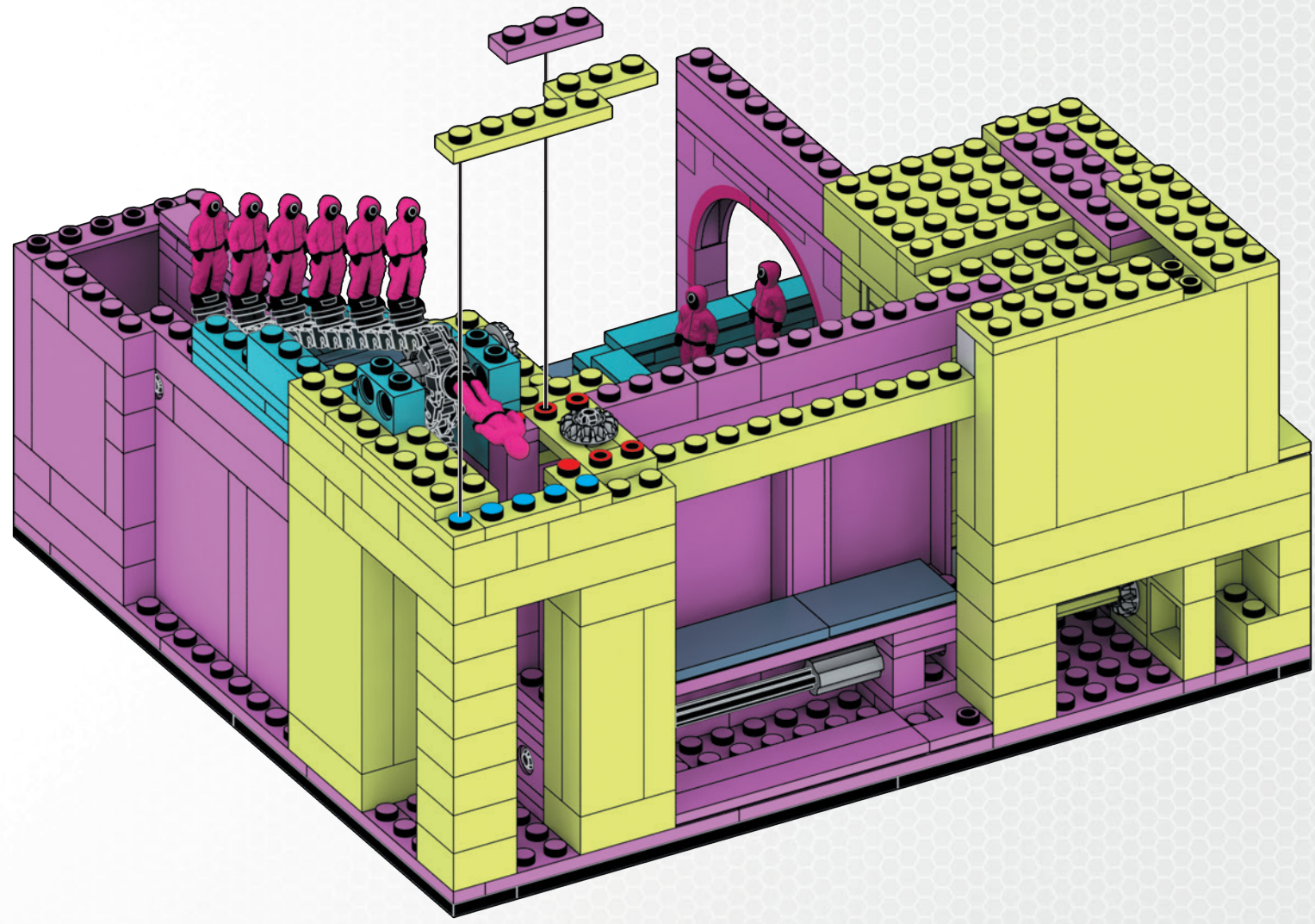
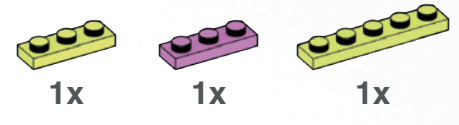

229



3x



1x



1

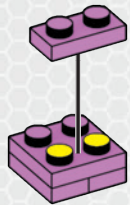

2

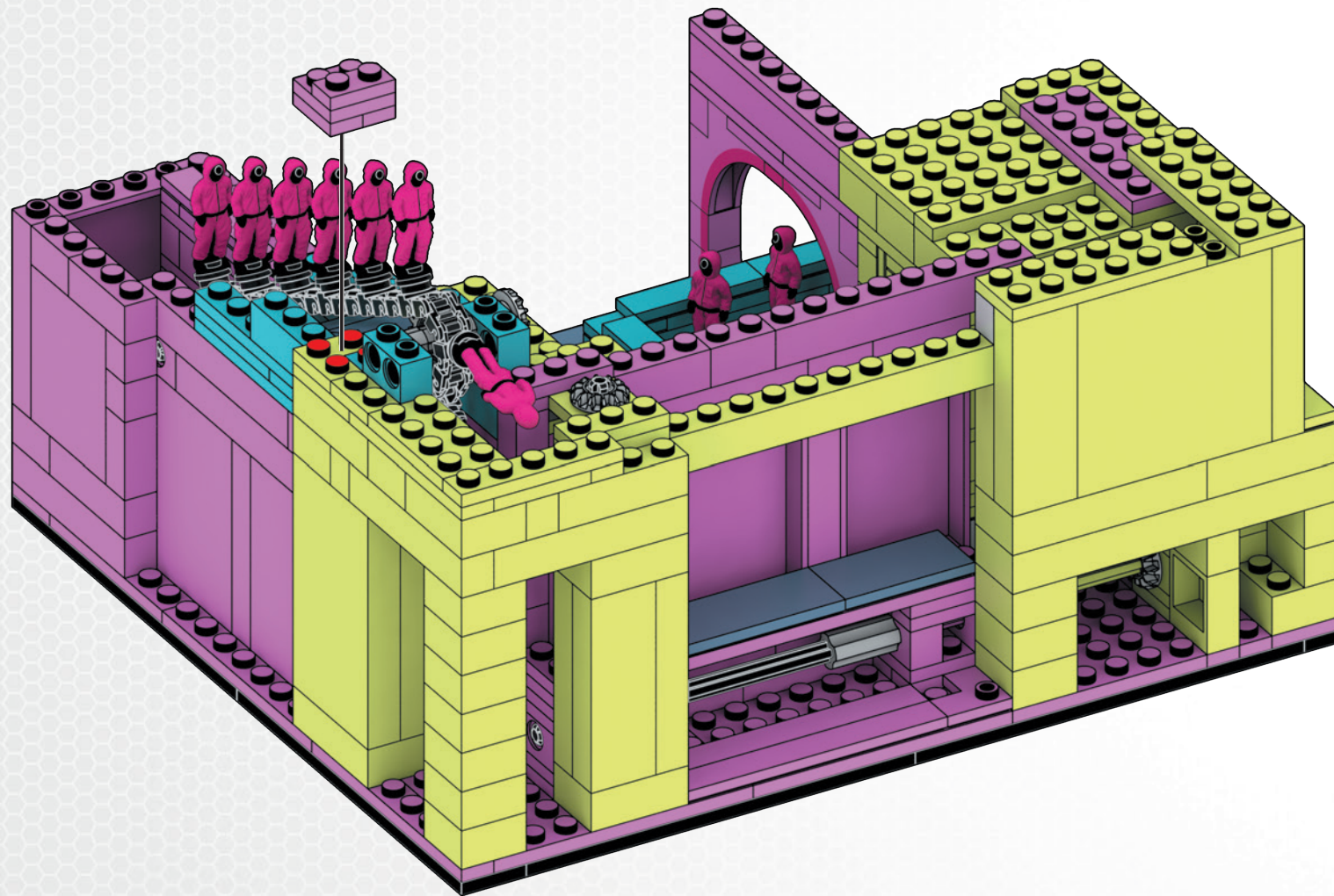

230

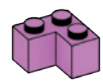

1x

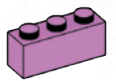

2x

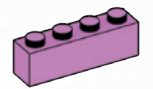

1x

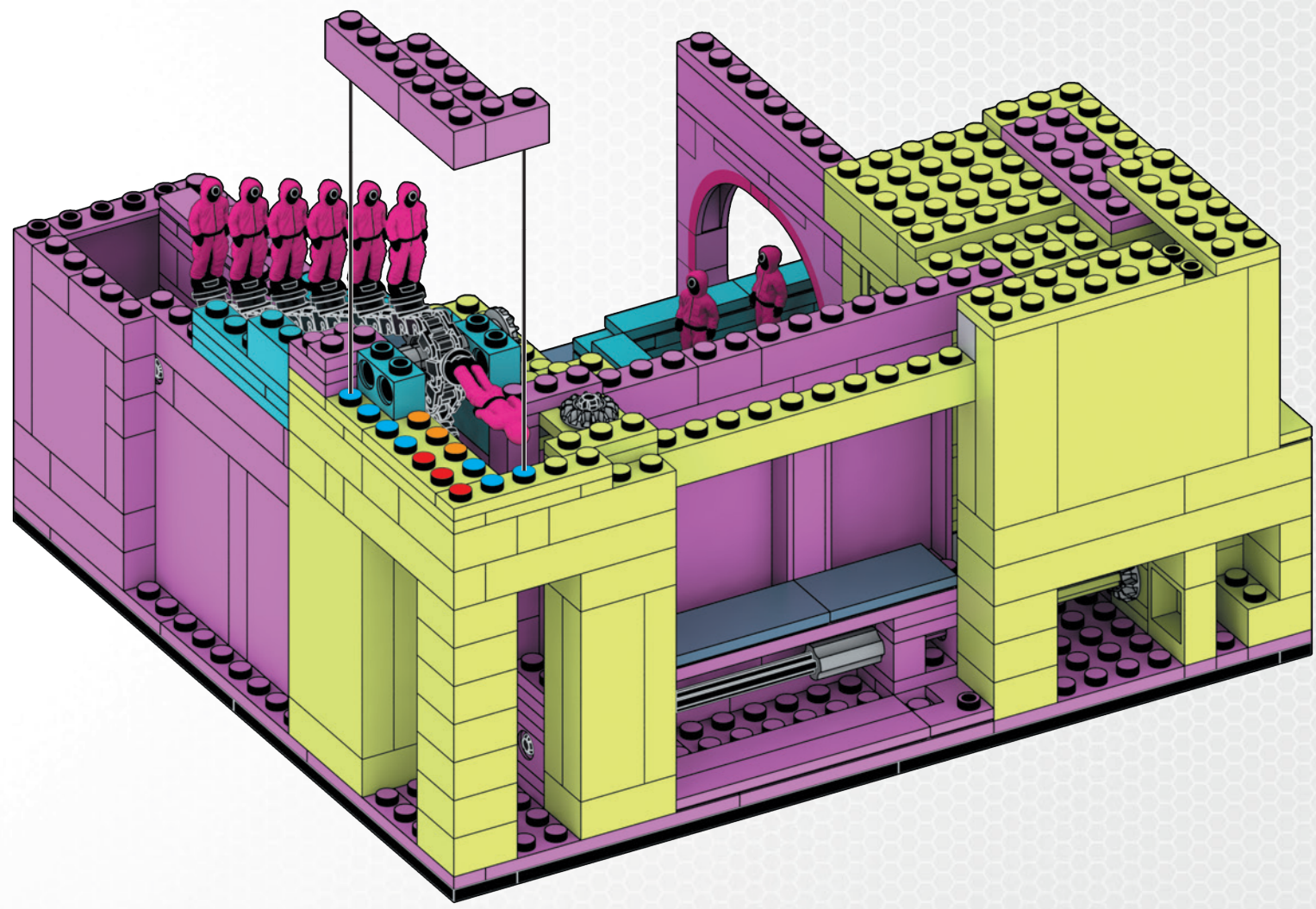

231



2x

1x6



1x

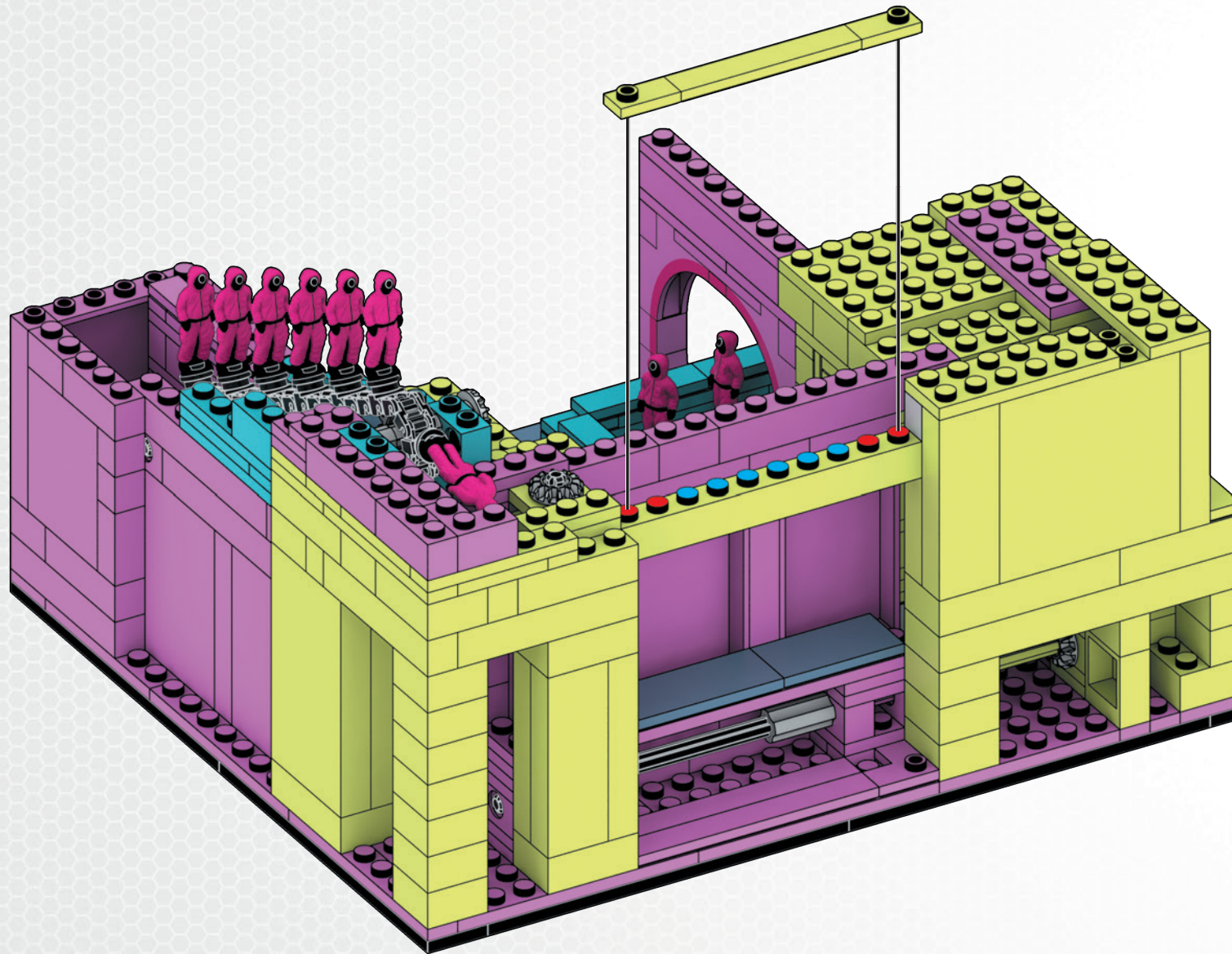

232



2x

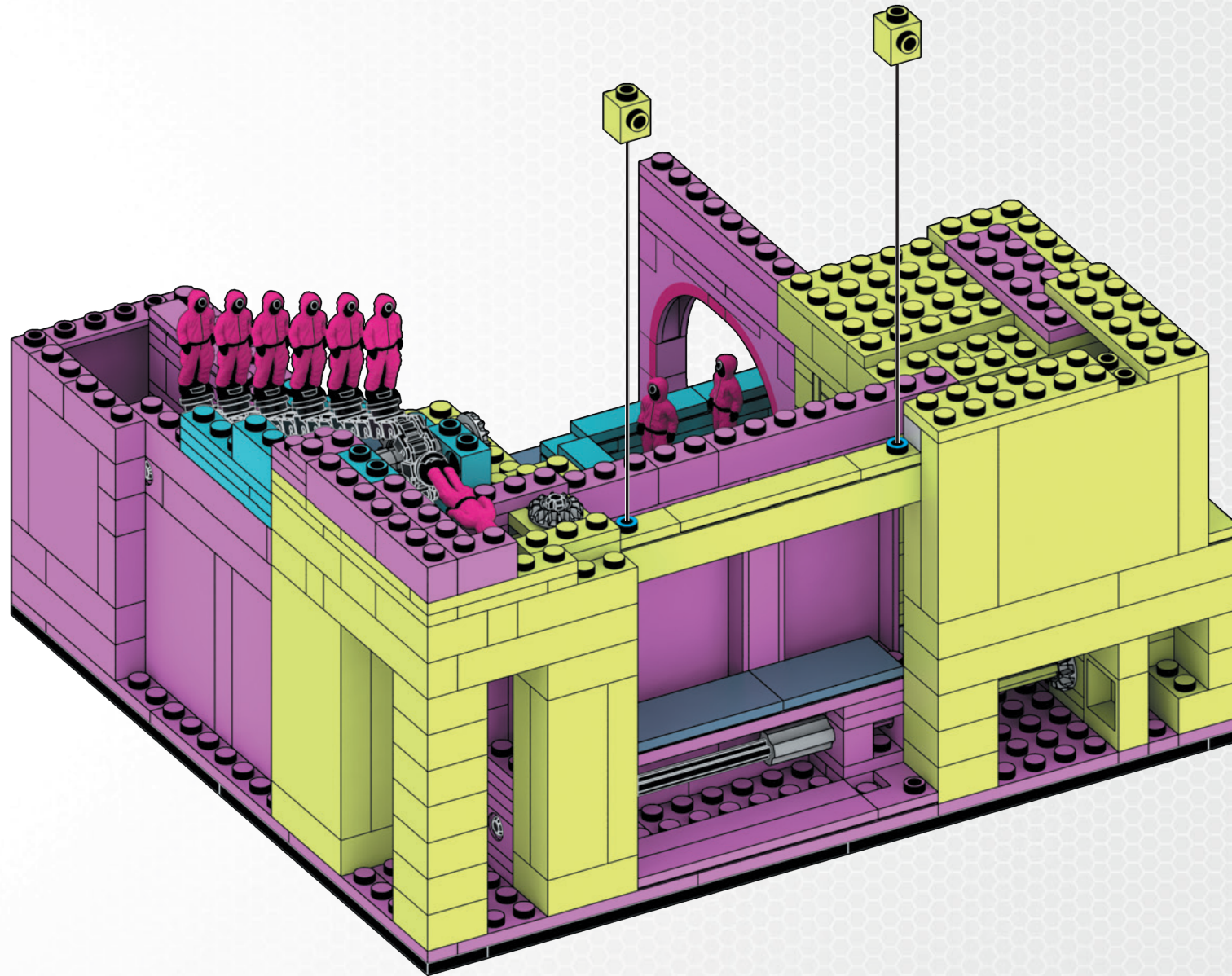

233

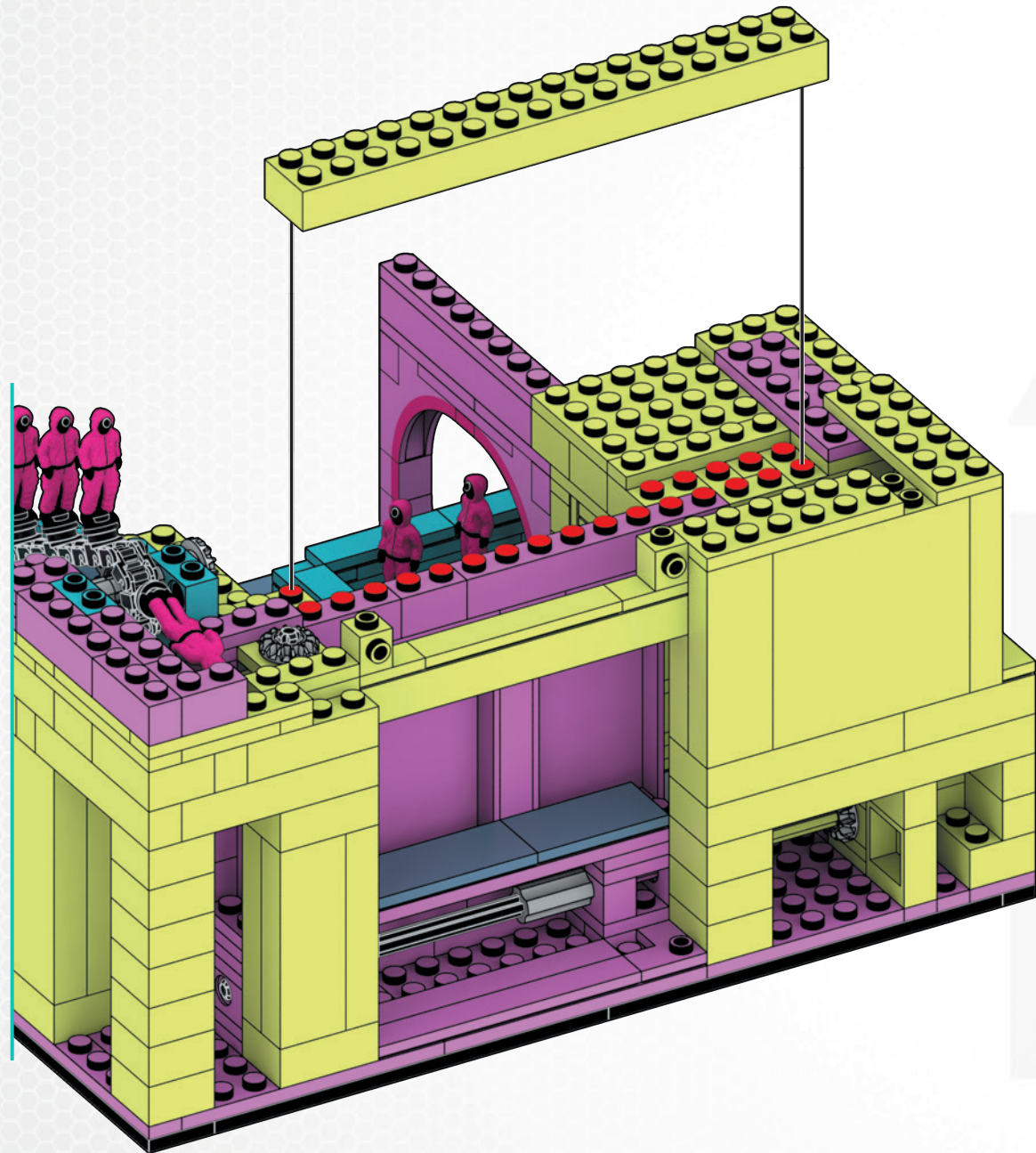
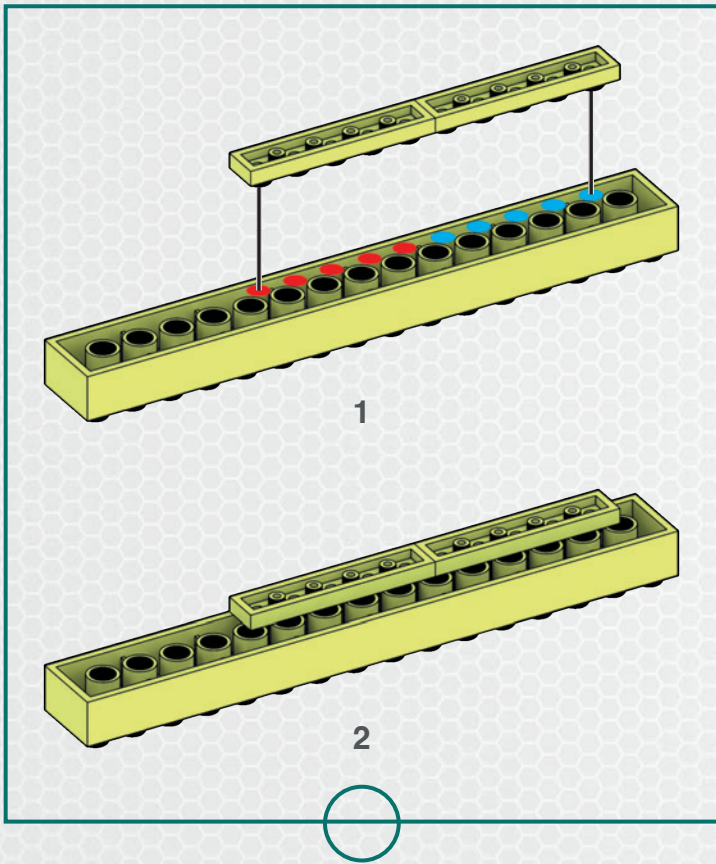
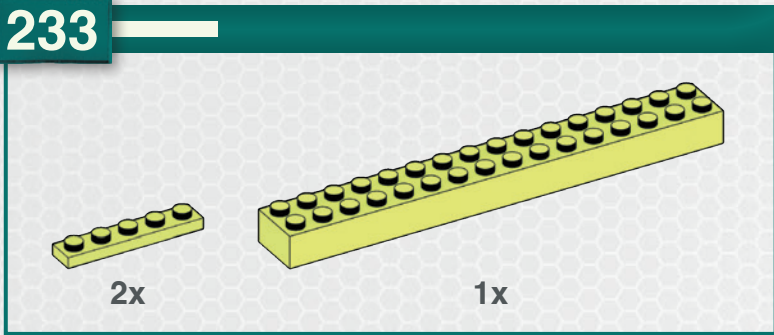

234



1x

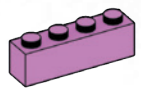

1x

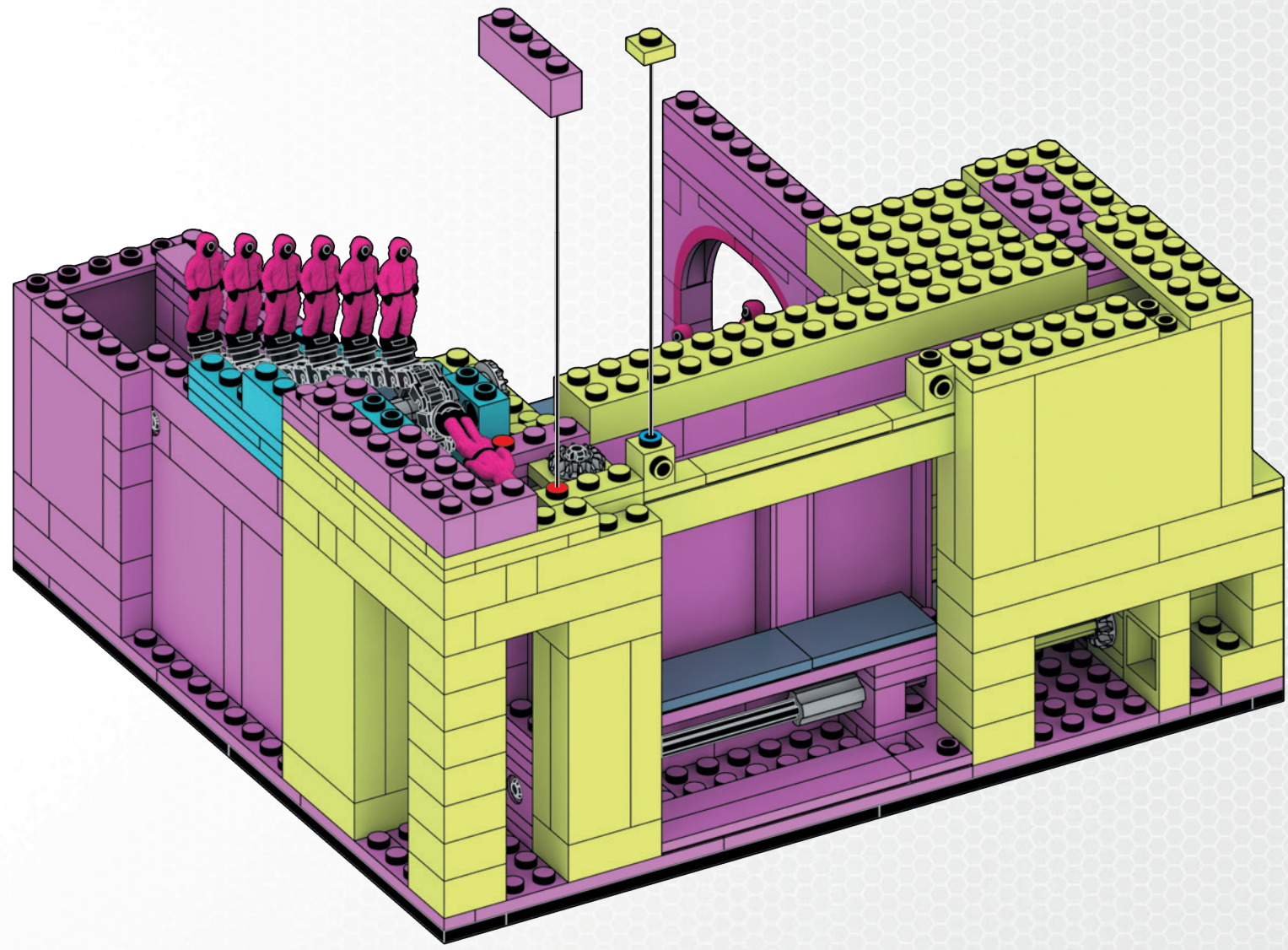

235

- 2x
- 3x
- 1x
- 1x
- 1x

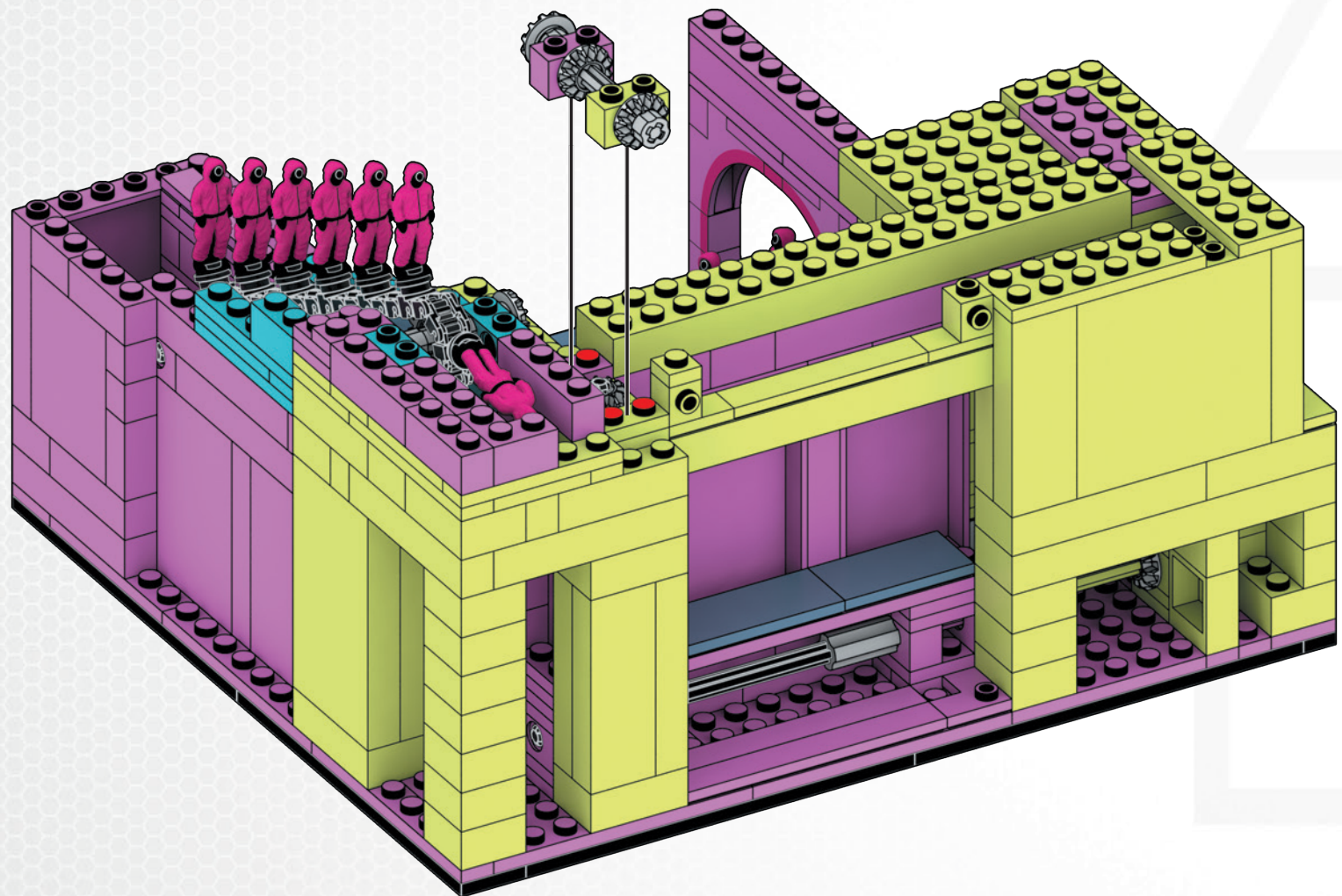
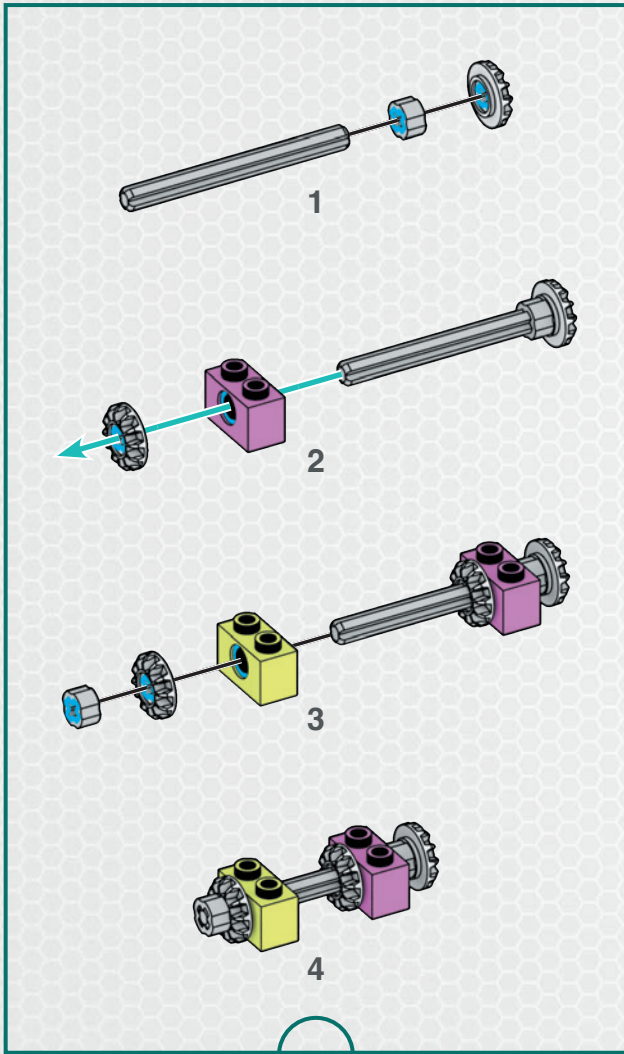

1

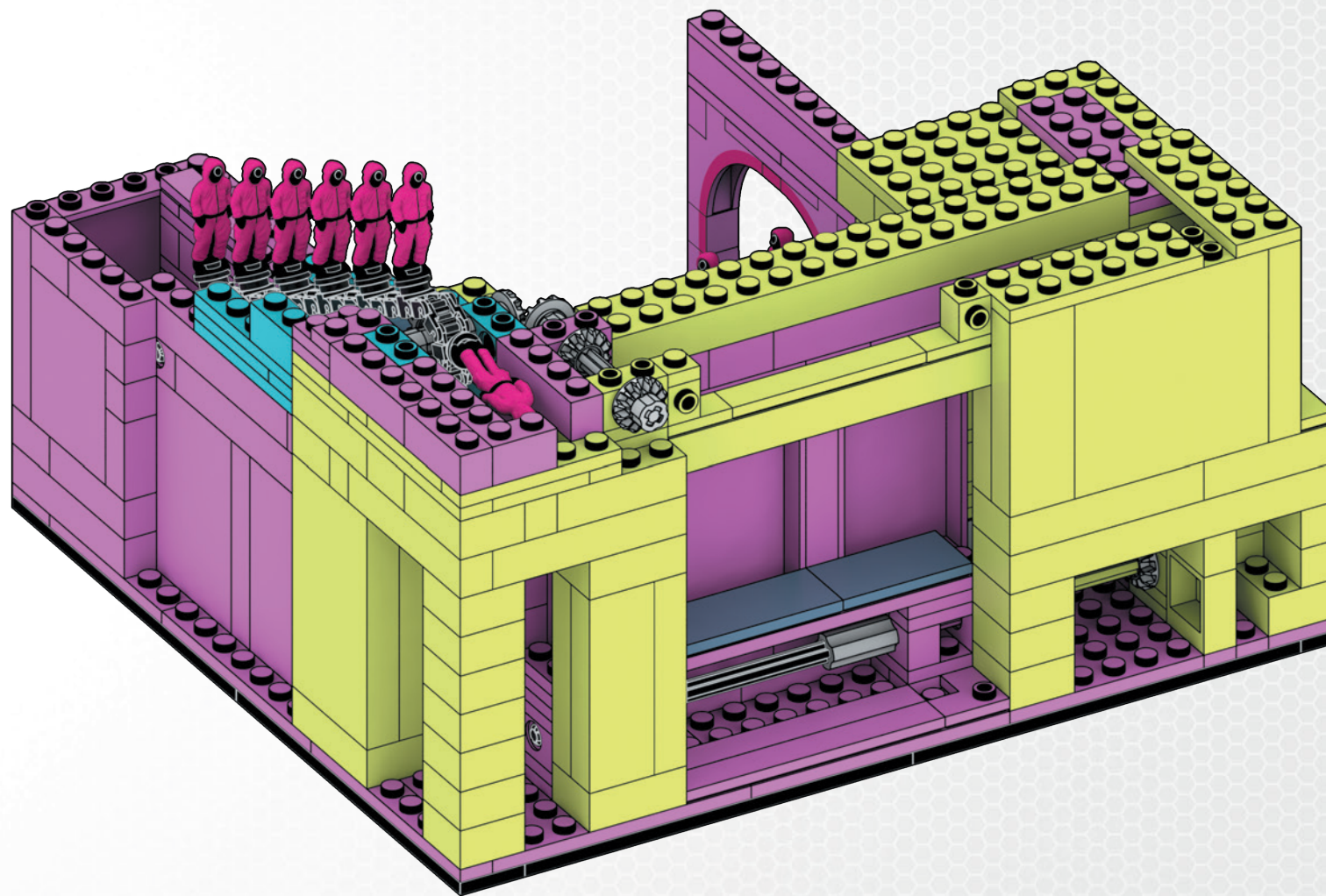

2

236

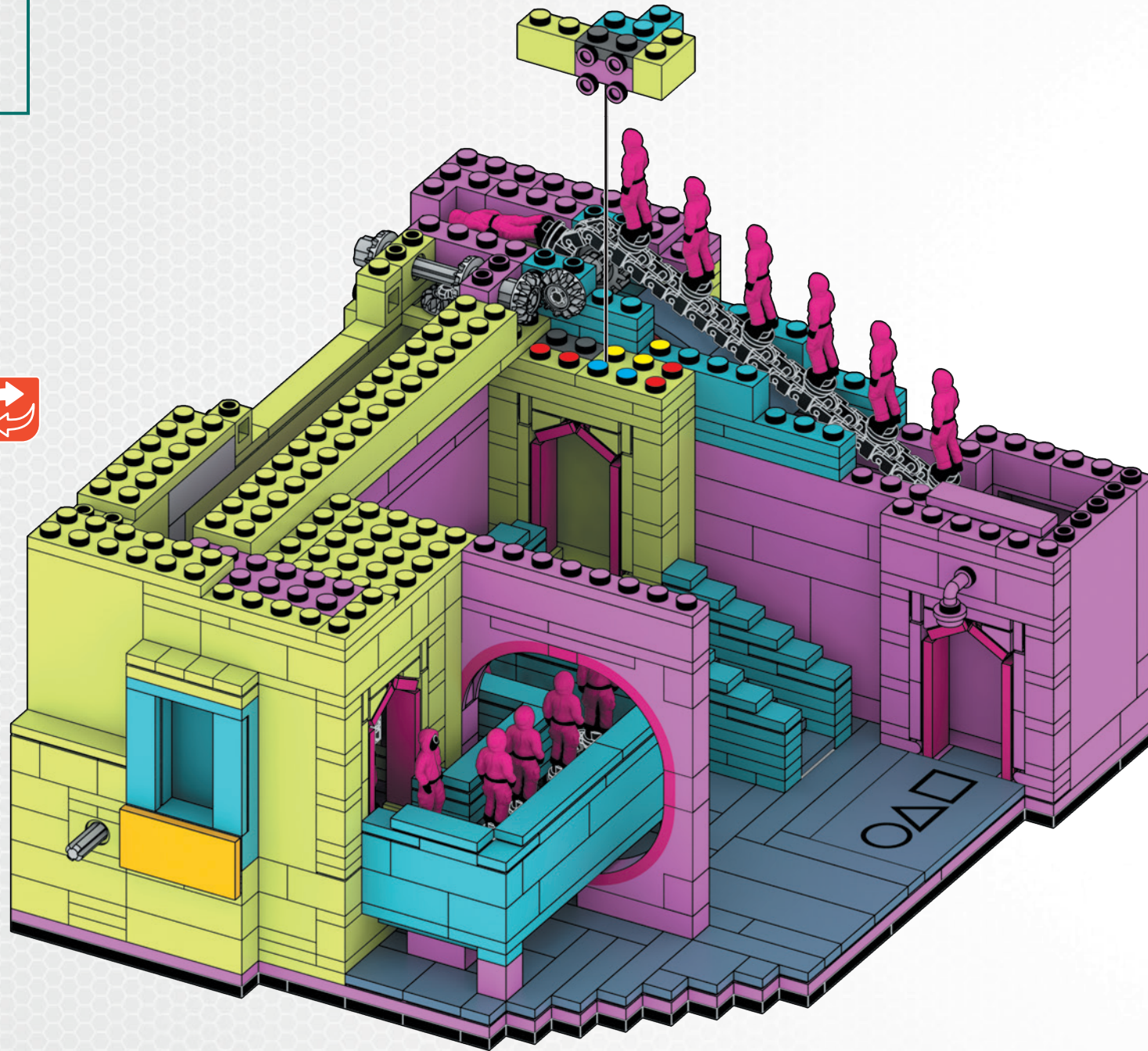
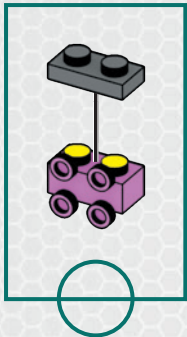
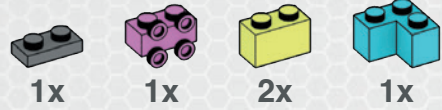

237

1x5



2x

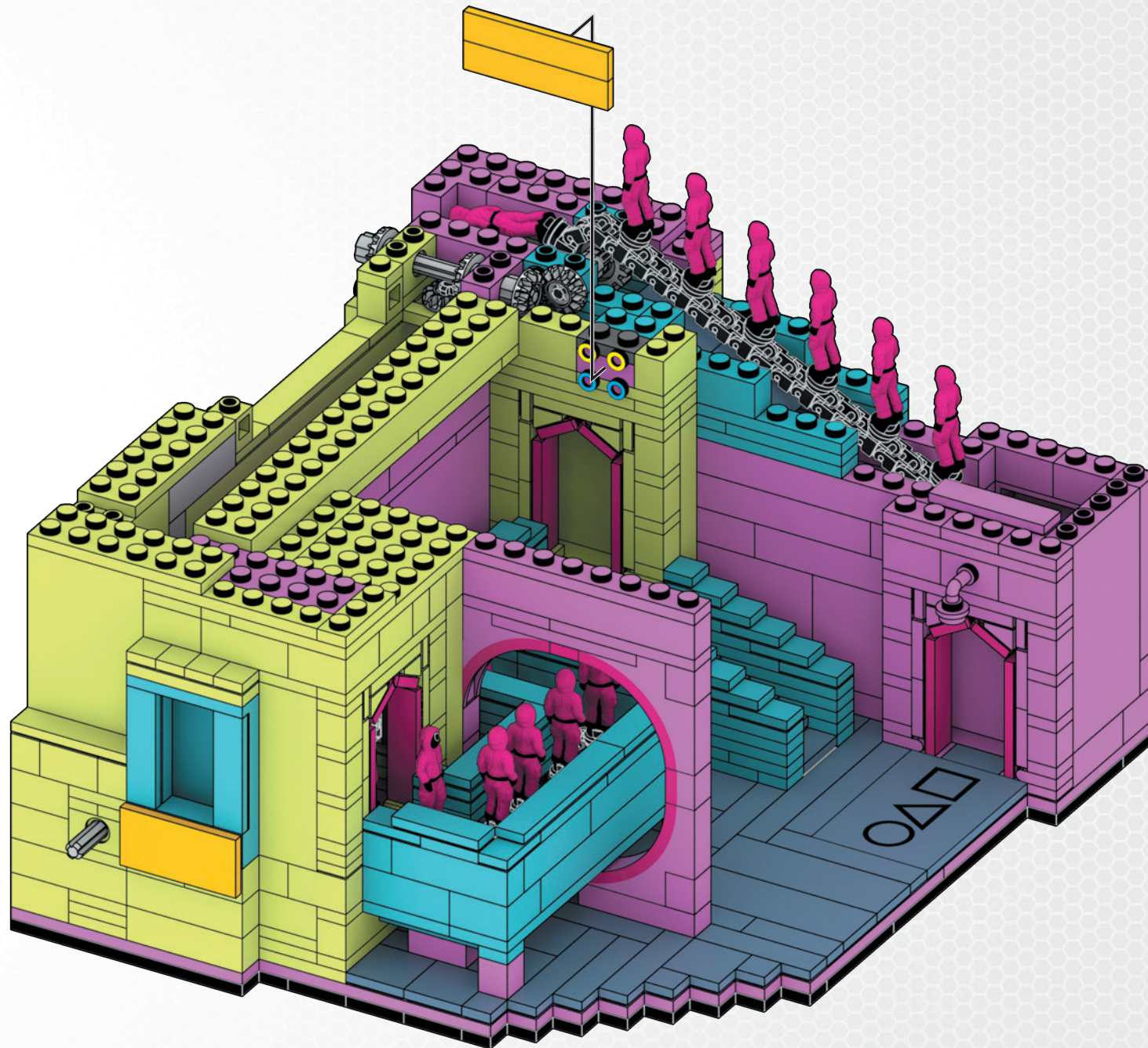

238



2x

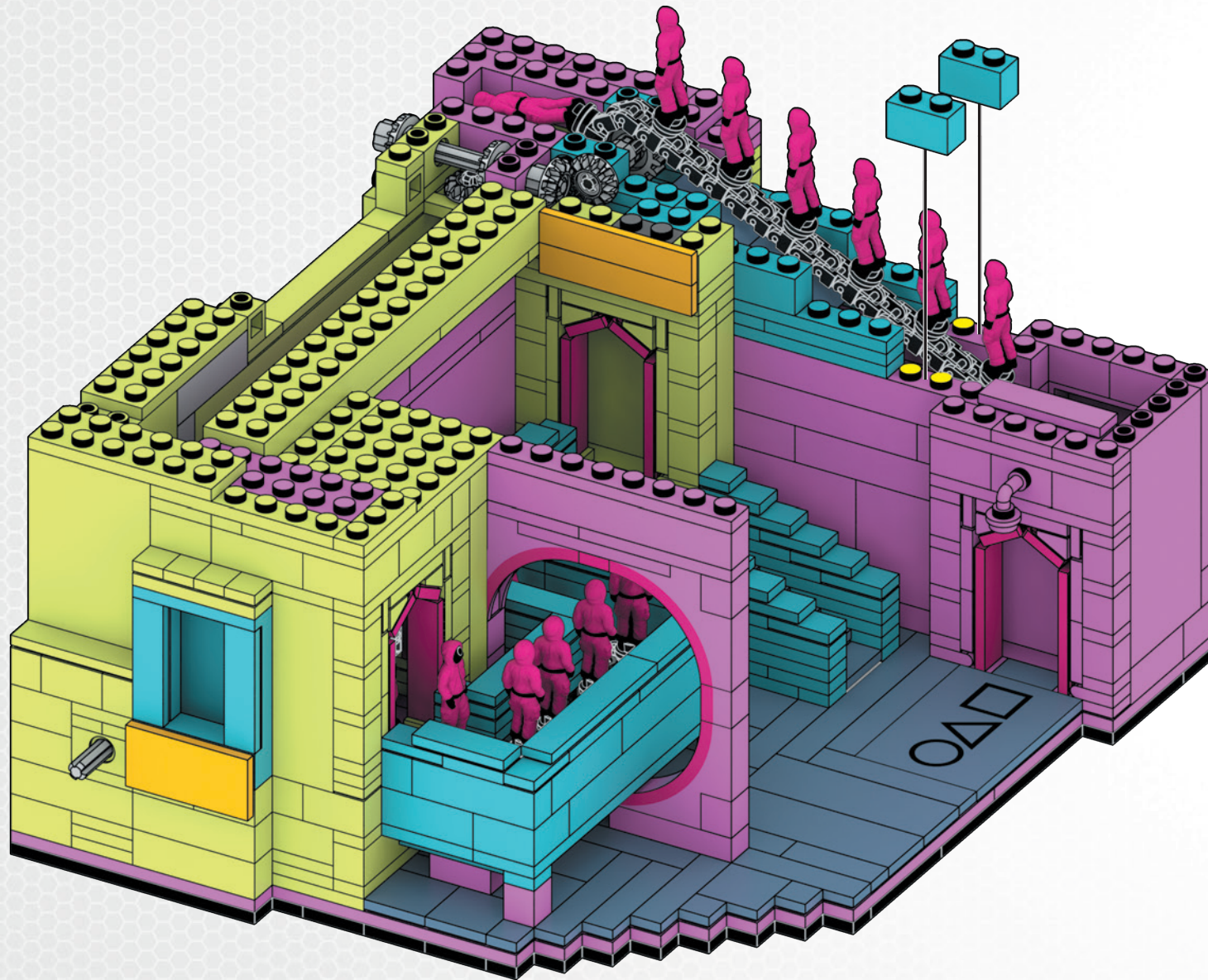

1

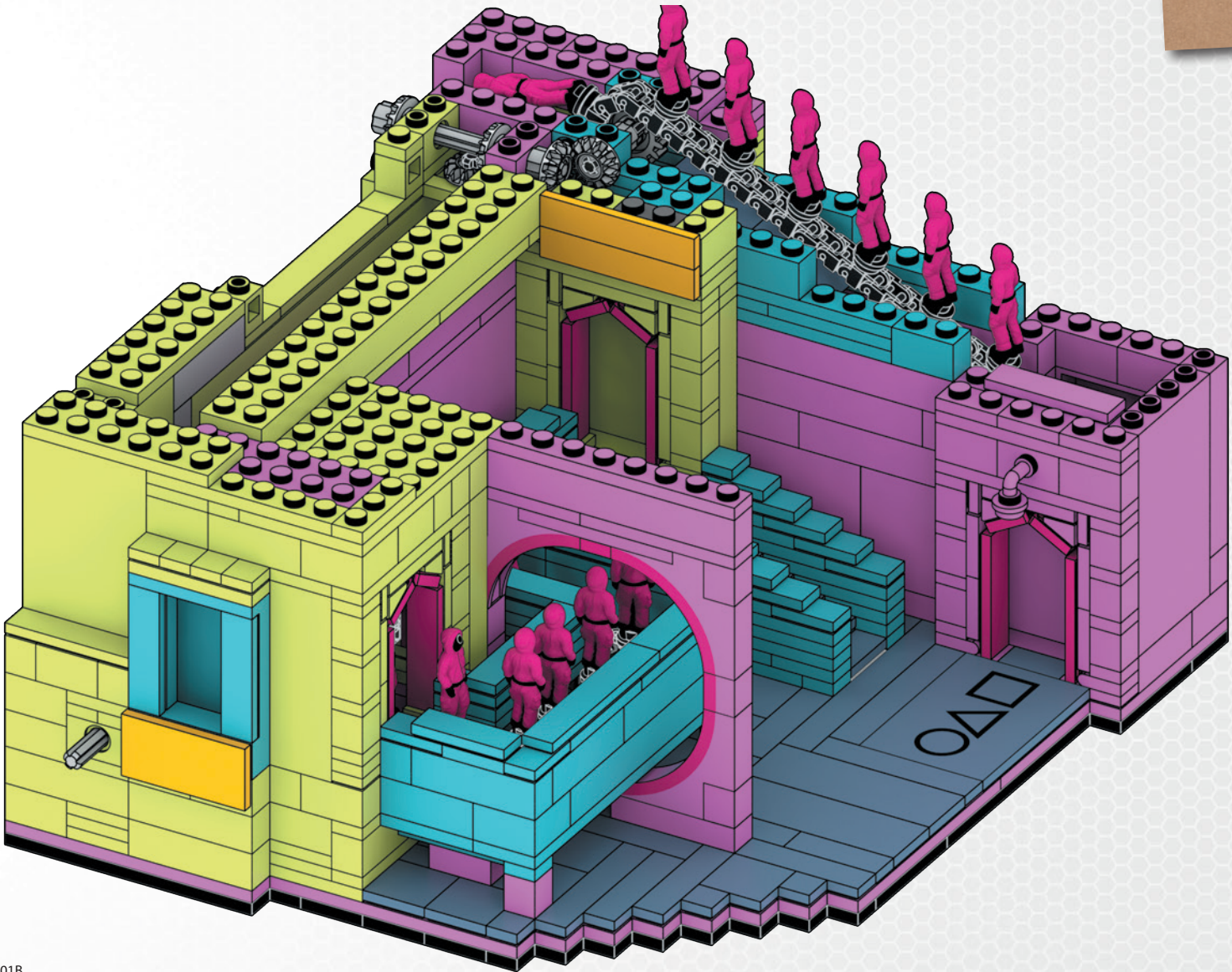

©2025 MEGA Brands &™ MEGA Brands.
Printed in China / Imprimé en Chine AD-HYL45-01B



2



1 1 1 1 1 1 1 1 1

