

**Fisher-Price®**

**L7836**



[www.fisher-price.com](http://www.fisher-price.com)



### WARNING

**Failure to follow these warnings and the instructions could result in serious injury or death.**

- **SUFFOCATION HAZARD** - Infants can suffocate:
  - in gaps between an extra pad and the side of the product.
  - on soft bedding
  - **NEVER** add a mattress, pillow, comforter, or padding. Use **ONLY** the pad provided by Fisher-Price®.
- **FALL HAZARD** - To prevent falls, **DO NOT** use this product when infant begins to push up on hands and knees or has reached 25 lbs (11.3 kg), whichever comes first.
- Strings can cause strangulation! **NEVER** place items with a string around a child's neck such as hood strings or pacifier cords. **NEVER** suspend strings over product or attach strings to toys.
- Never place product near a window where cords from blinds or drapes can strangle a child.
- To reduce the risk of Sudden Infant Death Syndrome (SIDS), pediatricians recommend healthy infants be placed on their backs to sleep, unless otherwise advised by your physician.
- Use **ONLY** the sheet provided by Fisher-Price® or one specifically designed to fit the dimensions of the pad.

**IMPORTANT! PLEASE KEEP THESE INSTRUCTIONS FOR FUTURE REFERENCE, AS THEY CONTAIN IMPORTANT INFORMATION.**

- Please read these instructions before assembly and use of this product.
- This product is intended for use with children who are not able to push up on hands and knees, pull up or sit unassisted.
- Adult assembly is required.
- Requires four "D" (LR20) **alkaline** batteries for motion, music and sounds operation (not included).
- Tools needed for assembly: Phillips screwdriver (not included) and Allen wrench (included).
- Product features and decorations may vary from photographs. Accessories shown in the storage basket are not included.

# Parts

**IMPORTANT!** Please remove all parts from the package and identify them before assembly. Some parts may be packed in the bassinet/storage basket.

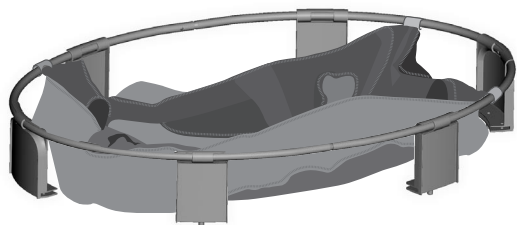

Storage Basket

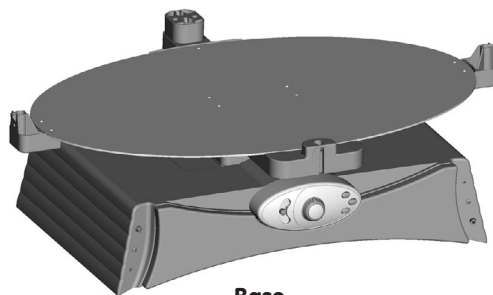

Base



Storage Basket Bottom

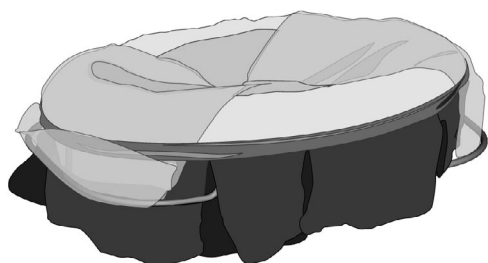

Bassinet with Canopy



Pad



Sheet

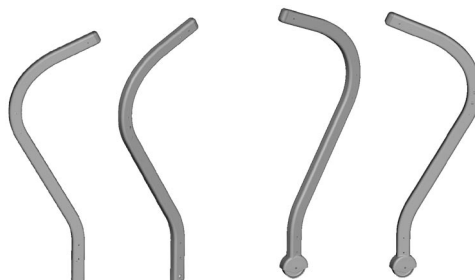

2 Legs

2 Legs with Wheels



Lower Canopy Tube



2 Large Diameter Tubes



2 Small Diameter Tubes

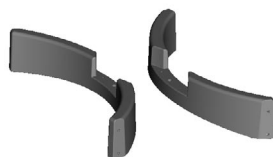

2 Braces



2 Handles



Allen Wrench



#8 x 3/4" (1,9 cm) Screw - 10



M6 x 40 mm Screw - 20

Note: Tighten or loosen the screws with a Phillips screwdriver or an Allen wrench. Do not over-tighten the screws.

Shown Actual Size

# Assembly

## CAUTION

This package contains small parts in its unassembled state. Adult assembly is required.

**IMPORTANT!** Before assembly and each use, inspect this product for damaged hardware, loose joints, torn fabrics, missing parts or sharp edges. DO NOT use if any parts are missing or broken. Contact Fisher-Price® for replacement parts and instructions if needed. Never substitute parts.

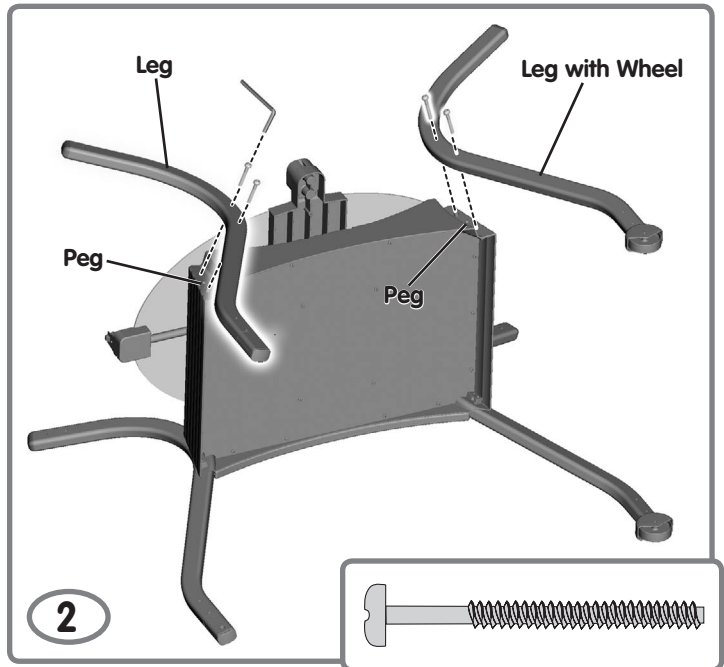

- Carefully turn the base assembly over.
- Match the number label on a leg with the number label on a corner of the base. Fit the leg to the peg on the base.
- Insert two M6 x 40 mm screws into the leg and tighten with the Allen wrench.
- Repeat this procedure to assemble the remaining leg with a wheel to the other corner of the base.

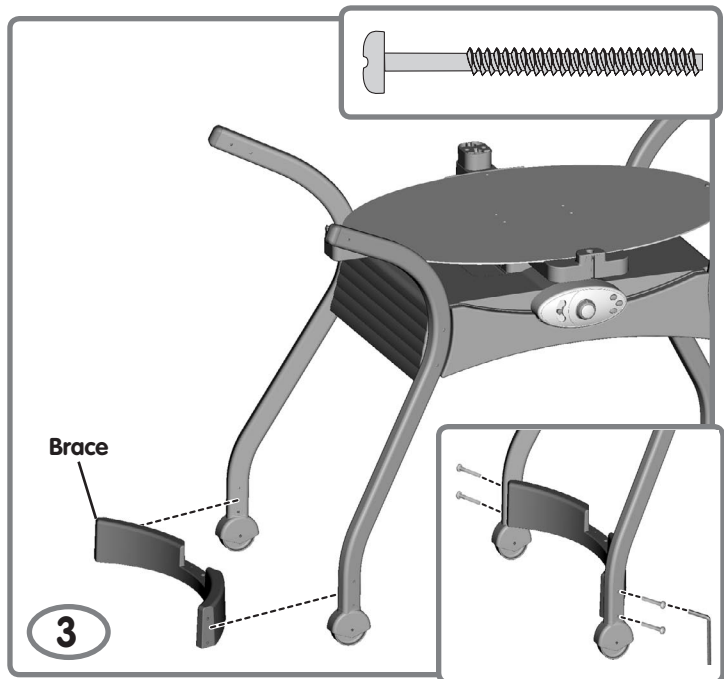

- Turn the assembly upright.
- Position a brace so that it curves away from you.
- Fit the brace to the bottom of two legs, as shown.
- First line up the holes in the brace with the holes in the legs. Then, insert two M6 x 40 mm screws into each leg. Tighten the screws with the Allen wrench.
- Repeat this procedure to attach the other brace to the base assembly.

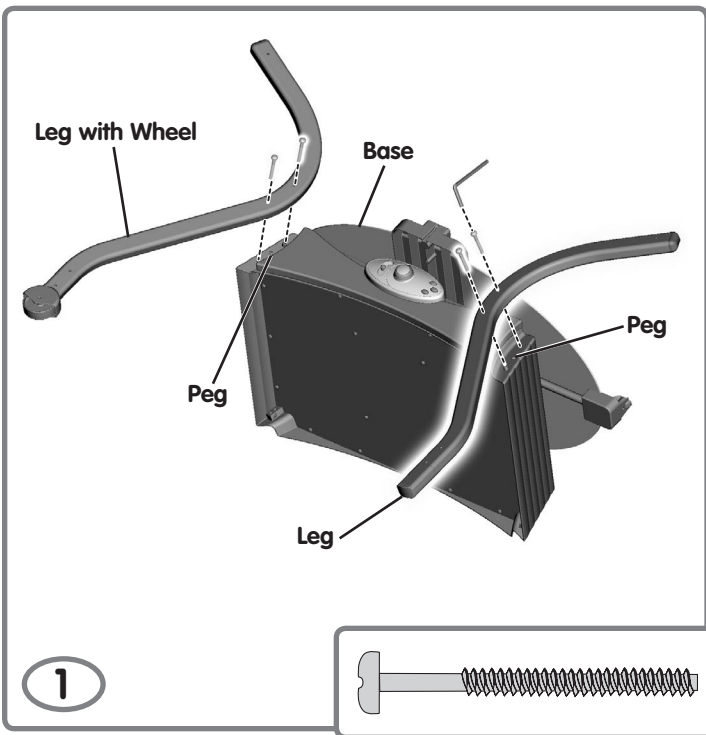

**Hint:** There are numbered labels on each leg and in each corner of the base. You will match the number on each leg to the number in each corner on the base.

- Carefully place the base on its side.
- Match the number label on a leg with the number label on a corner of the base. Fit the leg to the peg on the base.
- Insert two M6 x 40 mm screws into the leg and tighten with the Allen wrench.
- Repeat this procedure to assemble a leg with a wheel to the other corner of the base.

# Assembly

## Storage Basket Supports

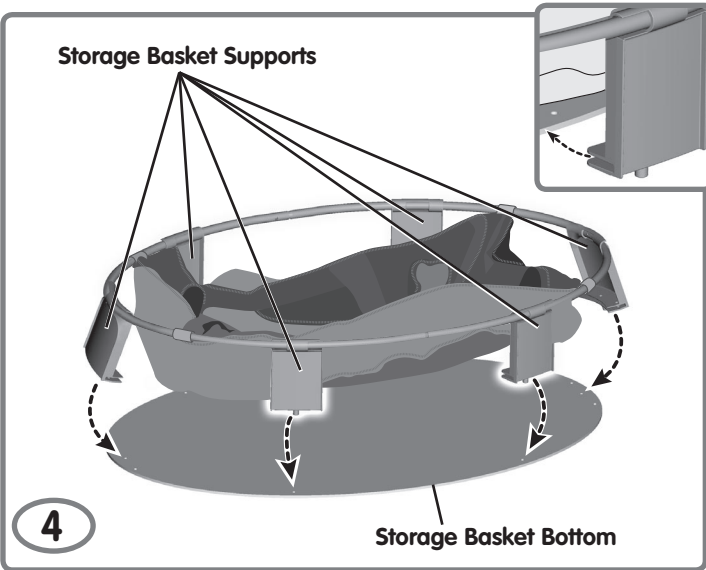

- Place the storage basket bottom on a flat surface.
- Align the hole in each storage basket support with the holes in the storage basket bottom.
- Fit the groove in a storage basket support onto the storage basket bottom.
- Repeat this procedure to attach the other five storage basket supports to the storage basket bottom.

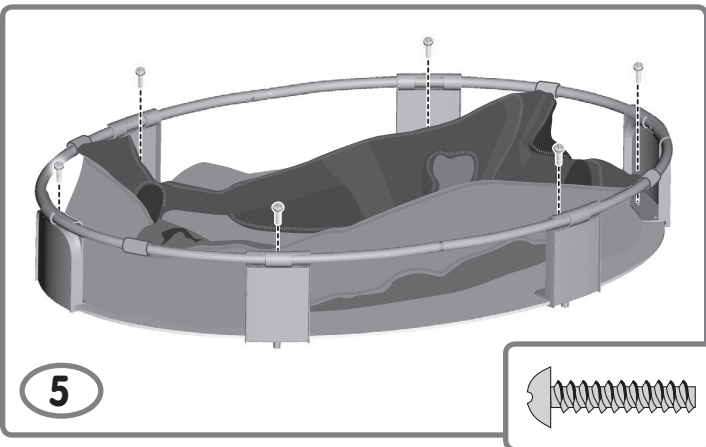

- Insert a #8 x 3/4" screw into each storage basket support and tighten with a Phillips screwdriver.

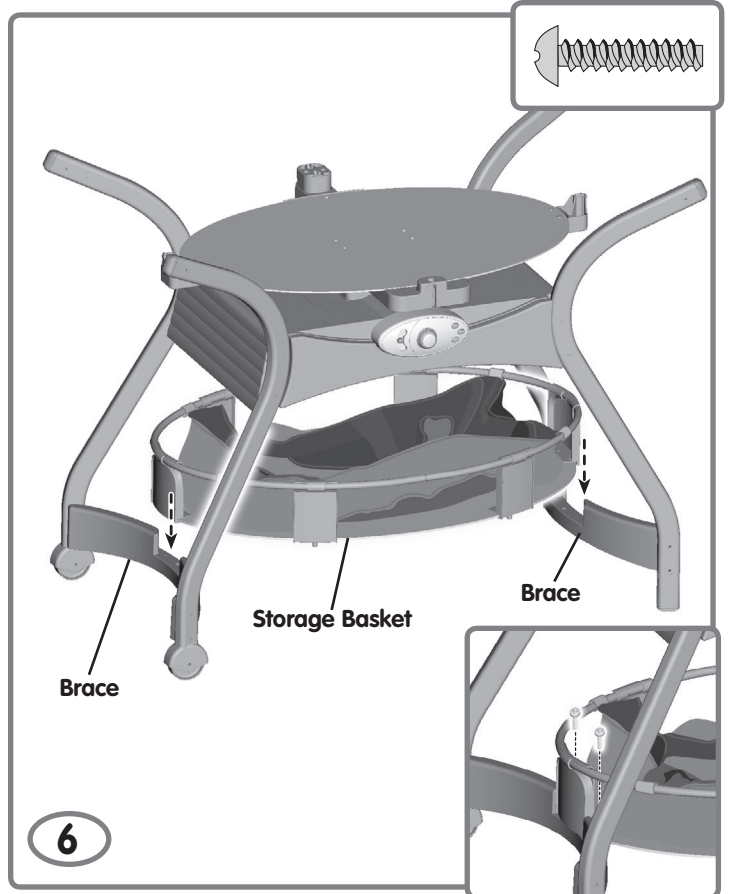

- Slide the storage basket onto the braces, as shown.
- Insert two #8 x 3/4" screws into the storage basket supports on each end of the storage basket. Tighten the screws with a Phillips screwdriver.

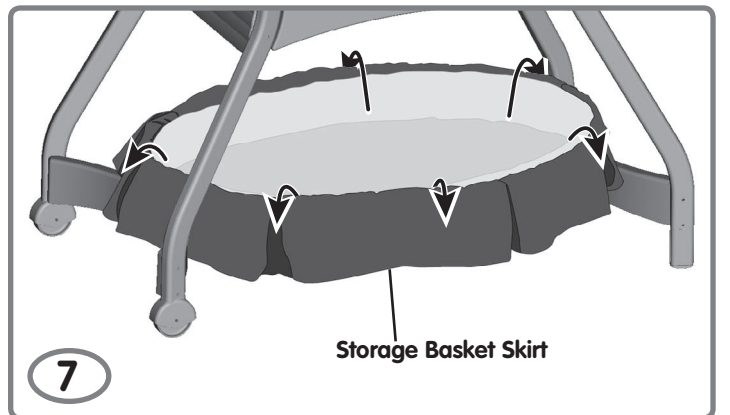

- Position the storage basket skirt over and around the top edge of the storage basket.

# Assembly

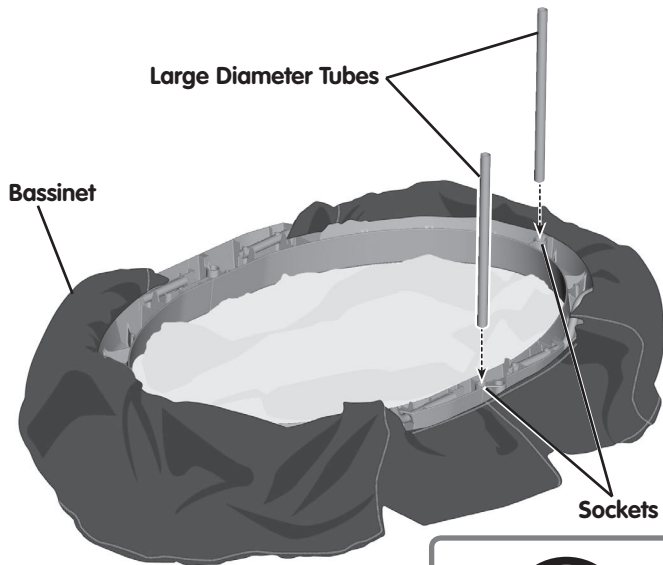

8

- Carefully turn the bassinet over and place on a flat surface.
- Locate the large diameter tubes.
- While pressing a button on a large diameter tube, insert it into a socket on one end of the bassinet. Push the tube until you hear a "click".

*Hint: The large diameter tubes will only fit in the large diameter sockets on the bassinet. If the tubes do not seem to fit, try another socket on the bassinet.*

- Repeat this procedure to assemble the other large diameter tube to the bassinet.

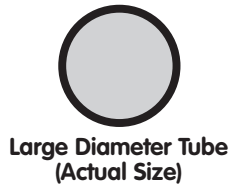

Large Diameter Tube  
(Actual Size)

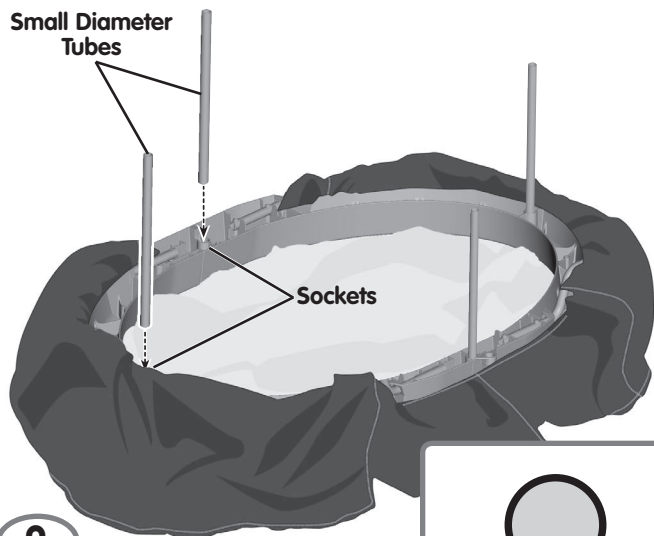

9

- Locate the small diameter tubes.
- While pressing a button on a small diameter tube, insert it into a socket on the other side of the bassinet.

- Repeat this procedure to assemble the other small diameter tube to the bassinet.

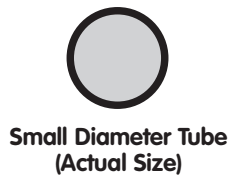

Small Diameter Tube  
(Actual Size)

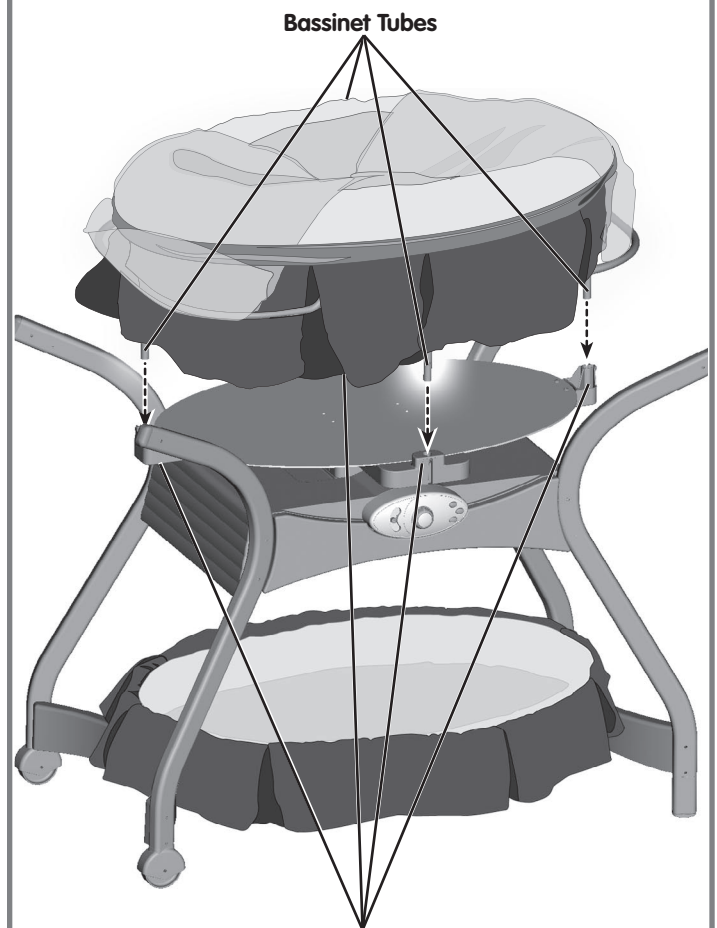

10

- Turn the bassinet upright.
- Fit the tubes on the bassinet into the sockets in the base.
- Push down near each tube until you hear a "click".
- Pull up on the bassinet to be sure it's secure to the base.

## Assembly

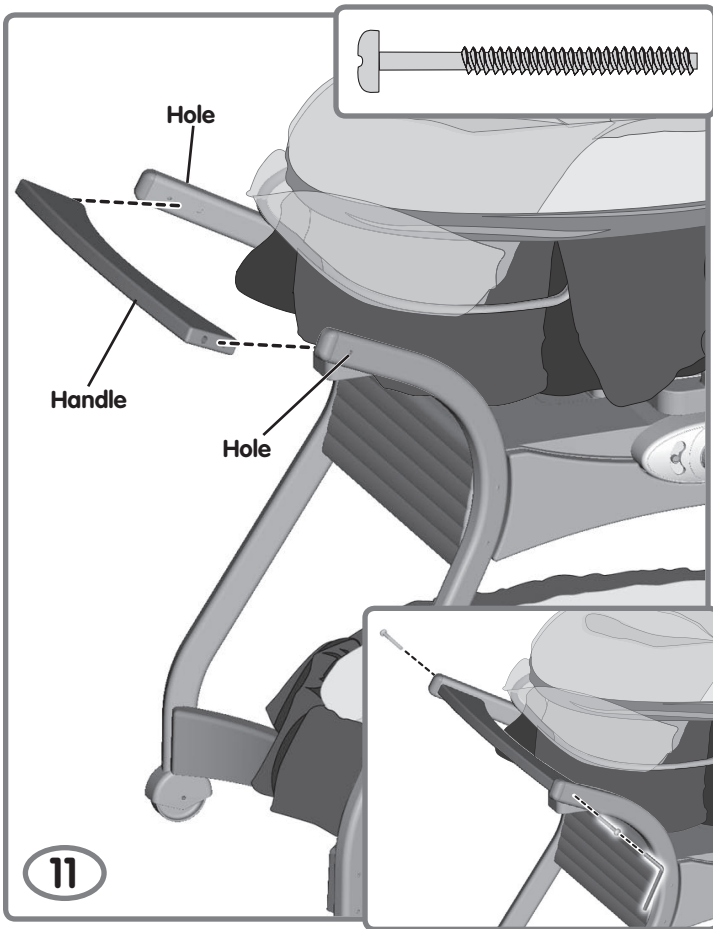

- Position a handle so that the curved edge is down.
- Fit a handle to the upper end of two legs, as shown.
- Insert an M6 x 40 mm screw into the hole in the top of each leg. Tighten each screw with the Allen wrench.
- Repeat this procedure to assemble the other handle to the assembly.

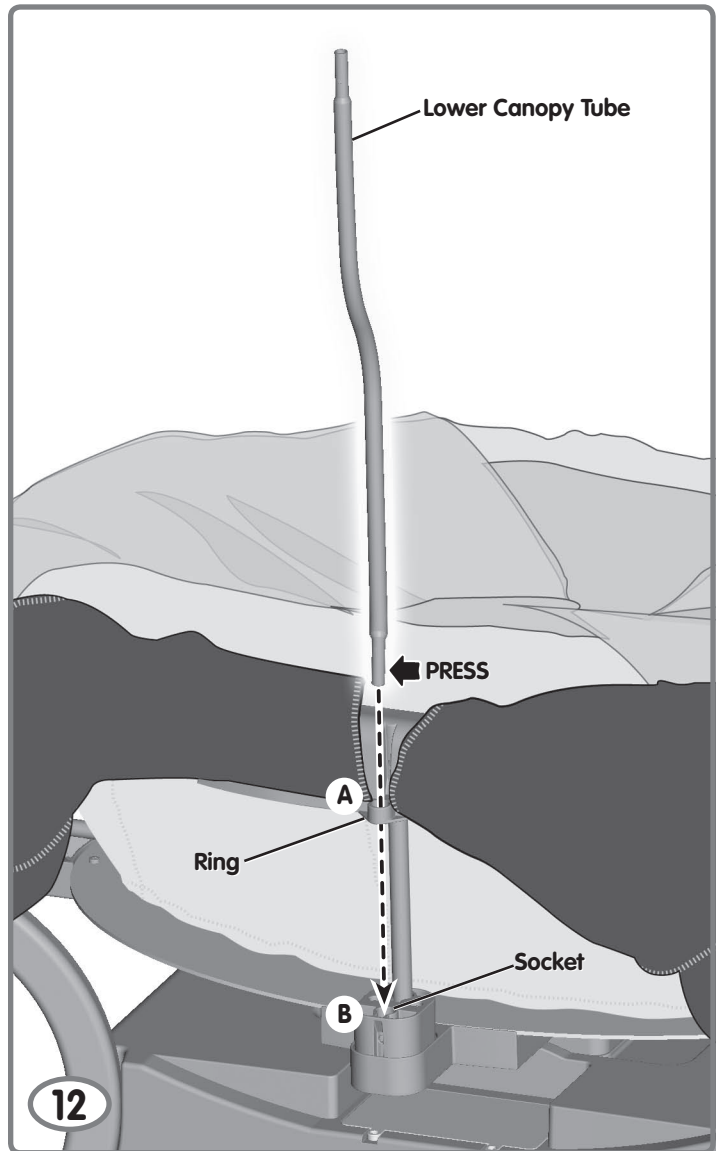

- Locate the ring on one side of the bassinet.
  - While pressing the button on the end of the lower canopy tube, insert it into the ring on the bassinet **A**.
- Hint:** If the lower canopy tube does not seem to fit into the ring, turn it over and try again!
- Insert the end of the lower canopy tube into the socket in the bassinet **B**. Push the tube until you hear a "click". Pull up on the tube to be sure it is secure.

## Assembly

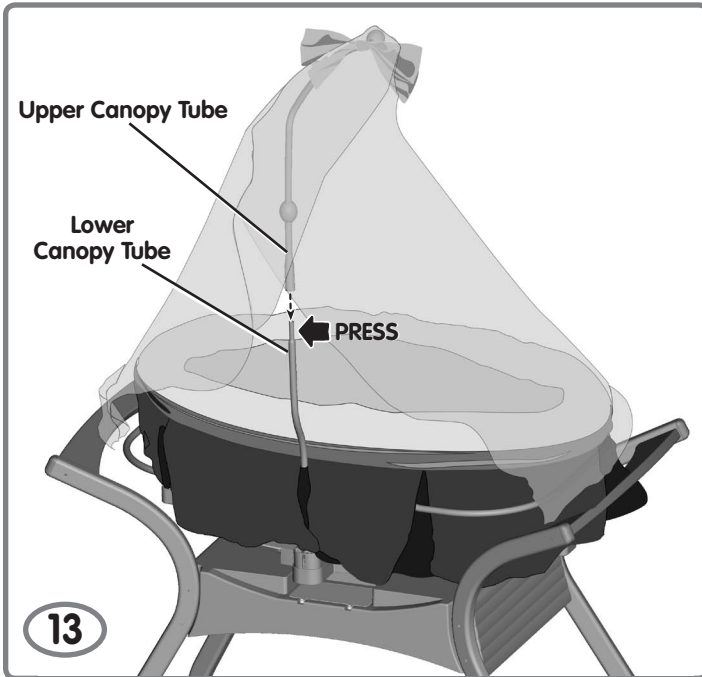

- Lift the upper canopy tube and smooth the canopy around the upper canopy tube.
- While pressing the button on the lower canopy tube, fit the upper canopy tube onto the lower canopy tube. Push until you hear a "click".
- Pull up on the upper canopy tube to be sure it is secure.

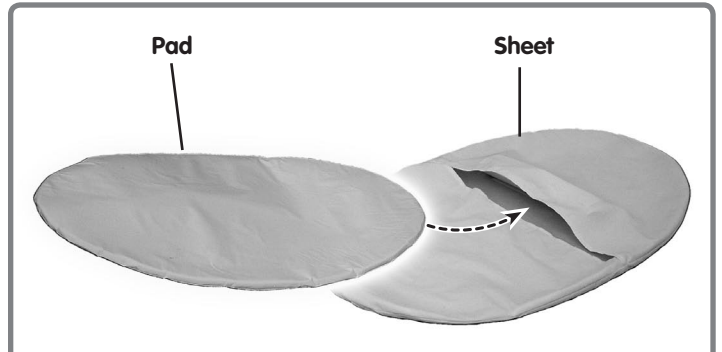

- Fit the pad into the slot in the sheet.
- Place the pad with sheet into the bassinet.



## Battery Installation

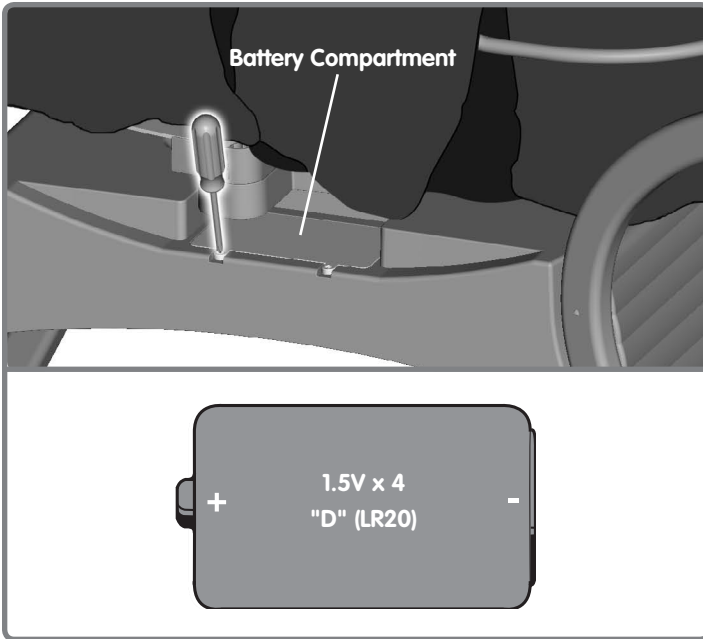

### Battery Safety Information

In exceptional circumstances, batteries may leak fluids that can cause a chemical burn injury or ruin your product. To avoid battery leakage:

- Do not mix old and new batteries or batteries of different types: alkaline, standard (carbon-zinc) or rechargeable (nickel-cadmium).
- Insert batteries as indicated inside the battery compartment.
- Remove batteries during long periods of non-use. Always remove exhausted batteries from the product. Dispose of batteries safely. Do not dispose of this product in a fire. The batteries inside may explode or leak.
- Never short-circuit the battery terminals.
- Use only batteries of the same or equivalent type, as recommended.
- Do not charge non-rechargeable batteries.
- Remove rechargeable batteries from the product before charging.
- If removable, rechargeable batteries are used, they are only to be charged under adult supervision.

- Locate the battery compartment on the back of the base.  
**Hint:** Align the notch in the base with the screw for easier access to the battery compartment.
- Loosen the screws in the battery compartment door with a Phillips screwdriver.
- Insert four "D" (LR20) **alkaline** batteries into the battery compartment.
- Replace the battery compartment door and tighten the screws.

**Note:** Low battery power may cause product movement to slow, sound to become faint or product to turn off all together. If this should happen, replace the batteries with four **alkaline** "D" (LR20) batteries.

-  • Protect the environment by not disposing of this product with household waste (2002/96/EC). Check your local authority for recycling advice and facilities (Europe only).



### WARNING

Failure to follow these warnings and the instructions could result in serious injury or death.

- **SUFFOCATION HAZARD** - Infants can suffocate:
  - in gaps between an extra pad and the side of the product.
  - on soft bedding
  - **NEVER** add a mattress, pillow, comforter, or padding. Use **ONLY** the pad provided by Fisher-Price®.
- **FALL HAZARD** - To prevent falls, **DO NOT** use this product when infant begins to push up on hands and knees or has reached 25 lbs (11.3 kg), whichever comes first.
- Strings can cause strangulation! **NEVER** place items with a string around a child's neck such as hood strings or pacifier cords. **NEVER** suspend strings over product or attach strings to toys.
- Never place product near a window where cords from blinds or drapes can strangle a child.
- To reduce the risk of Sudden Infant Death Syndrome (SIDS), pediatricians recommend healthy infants be placed on their backs to sleep, unless otherwise advised by your physician.
- Use **ONLY** the sheet provided by Fisher-Price® or one specifically designed to fit the dimensions of the pad.



- For best performance, make sure this product is used **only** on a completely level surface.

## Gliding Bassinet

## FCC Statement (United States Only)



### Glider

- Turn the power/speed dial to begin gliding.

**Hint:** In most cases, a slower setting works best for a smaller child, while a faster setting works best for a larger child. If gliding stops while using a slow setting, try a faster setting. Give the seat a light push to start the gliding motion again.

- Gliding will continue for about 20 minutes and then turn off. To start gliding again, simply turn the power/speed dial to the reset position (off) and then back on to the desired speed setting.
- Be sure to turn this product off when not in use. Turn the power/speed dial to the off setting **O**.

**Note:** If gliding motion is slow in one direction (and you hear a winding or grinding noise), you may be using this product on an inclined surface. Use this product **only** on a completely level surface.

### Music and Sounds

- Slide the music and sounds power/volume switch to on with lower volume or on with higher volume.
- Press a music/sounds selection button for music, nature or simulated womb sounds.
- Listen to music or sounds for about 20 minutes. Press any of the music and sounds buttons to restart music or sounds.
- Be sure to turn off music and sounds when not in use. Slide the music and sounds power/volume switch off **O**.

### FCC Statement (United States Only)

This equipment has been tested and found to comply with the limits for a Class B digital device, pursuant to Part 15 of the FCC Rules. These limits are designed to provide reasonable protection against harmful interference in a residential installation. This equipment generates, uses and can radiate radio frequency energy and, if not installed and used in accordance with the instructions, may cause harmful interference to radio communications. However, there is no guarantee that interference will not occur in a particular installation. If this equipment does cause harmful interference to radio or television reception, which can be determined by turning the equipment off and on, the user is encouraged to try to correct the interference by one or more of the following measures:

- Reorient or relocate the receiving antenna.
- Increase the separation between the equipment and receiver.
- Consult the dealer or an experienced radio/TV technician for help.

**Note:** Changes or modifications not expressly approved by the manufacturer responsible for compliance could void the user's authority to operate the equipment.

This device complies with Part 15 of the FCC Rules.

Operation is subject to the following two conditions: (1) This device may not cause harmful interference and (2) this device must accept any interference received, including interference that may cause undesired operation.

## Care

- The pad, frame, bassinet, storage basket and canopy may be wiped clean with a mild cleaning solution and a damp cloth. Do not use bleach. Do not use harsh or abrasive cleaners. Rinse clean with water to remove residue. Do not immerse the frame.
- The sheet is machine washable. Wash it separately in cold water on the gentle cycle. Do not use bleach. Tumble dry separately on low heat and remove promptly.



## CONSUMER ASSISTANCE

Call toll free: 1-800-432-5437 (US & Canada only)  
M-F 9AM to 7PM / SAT 11AM to 5PM (EST)

[service.fisher-price.com](http://service.fisher-price.com)

Write to us at: Fisher-Price® Consumer Relations,  
636 Girard Avenue, East Aurora, New York 14052.

Hearing-impaired consumers using TTY/TDD equipment,  
please call 1-800-382-7470.

*In Mexico: 59-05-51-00 Ext. 5206 ó 01-800-46359-89*  
*In Brasil: 0800 550780*

### CANADA

Mattel Canada Inc., 6155 Freemont Blvd.,  
Mississauga, Ontario L5R 3W2; [www.service.mattel.com](http://www.service.mattel.com).

### MÉXICO

Importado y distribuido por Mattel de México, S.A. de C.V.,  
Insurgentes Sur #3579, Torre 3, Oficina 601, Col. Tlalpan,  
Delegación Tlalpan, C.P. 14020, México, D.F. R.F.C. MME-920701-NB3.

### CHILE

Mattel Chile, S.A., Avenida Américo Vespucio 501-B, Quilicura, Santiago, Chile.

### VENEZUELA

Mattel de Venezuela, C.A., RIF J301596439, Ave. Mara, C.C. Macaracuay Plaza,  
Torre B, Piso 8, Colinas de la California, Caracas 1071.

### ARGENTINA

Mattel Argentina, S.A., Curupayí 1186, (1607) – Villa Adelina, Buenos Aires.

### COLOMBIA

Mattel Colombia, S.A., calle 123#7-07 P.5, Bogotá.

### BRASIL

Importado por : Mattel do Brasil Ltda.- CNPJ : 54.558.002/0008-04 - Av.  
Tenente Marques, 1246 - Sala 02 - 2º. Andar - 07770-000 - Polvilho -  
Cajamar - SP – Brasil. Serviço de Atendimento ao Consumidor (SAC):  
[sac@mattel.com](mailto:sac@mattel.com).