

3+

Barbie®

# INSTRUCTIONS

M3478-0920

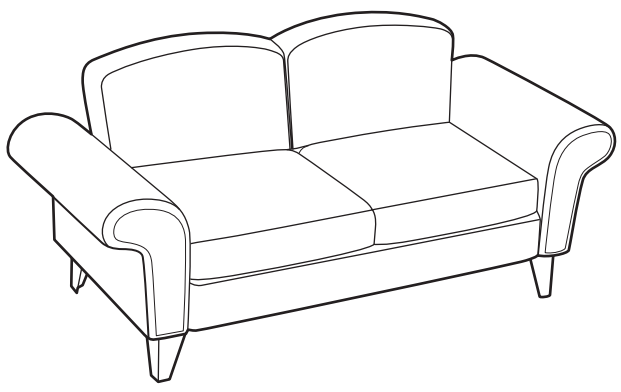
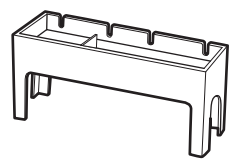
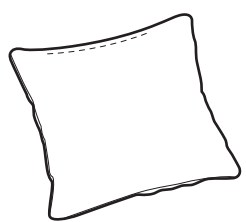
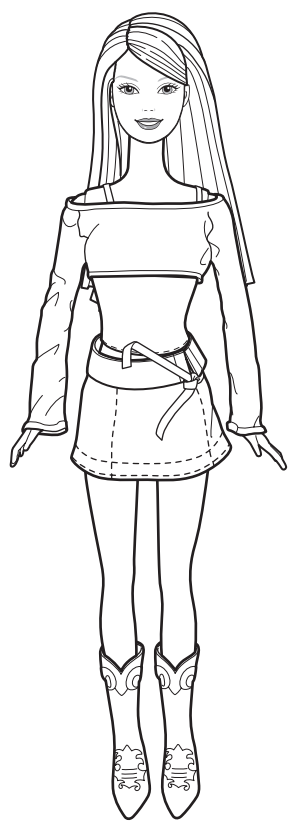
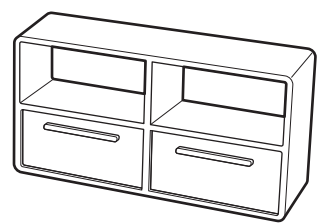
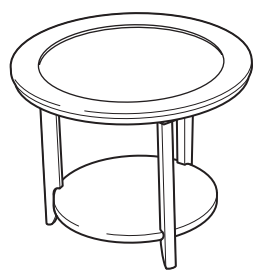
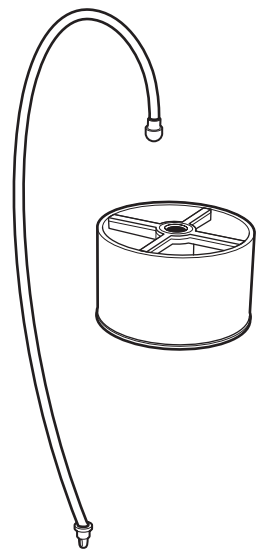
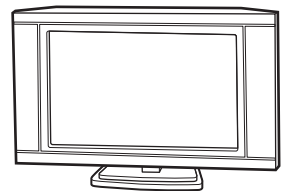
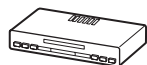
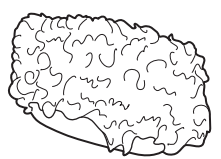
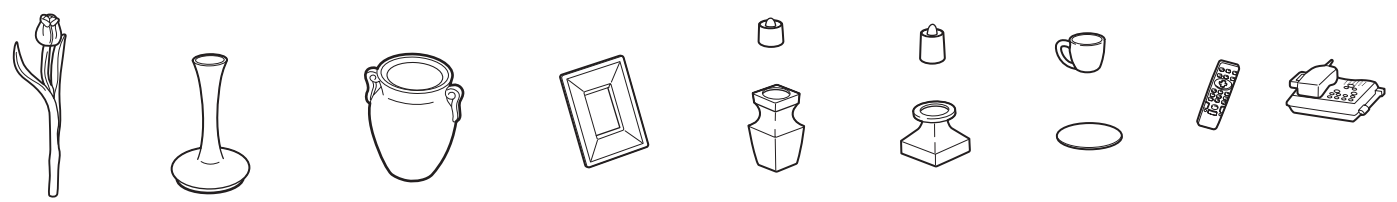

**Contents:** Please remove everything from the package and compare to the contents shown here. If any items are missing, please contact your local Mattel office. Keep these instructions for future reference as they contain important information.

**WARNING:**  
CHOKING HAZARD - Small parts.  
Not for children under 3 years.

# Play Time!

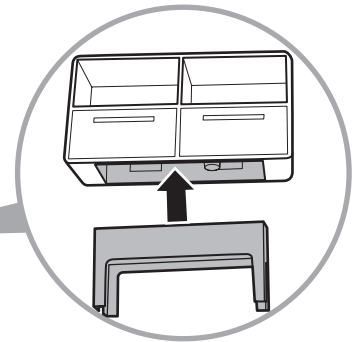
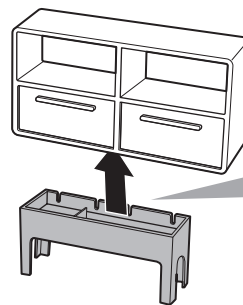
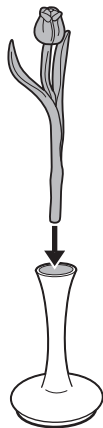
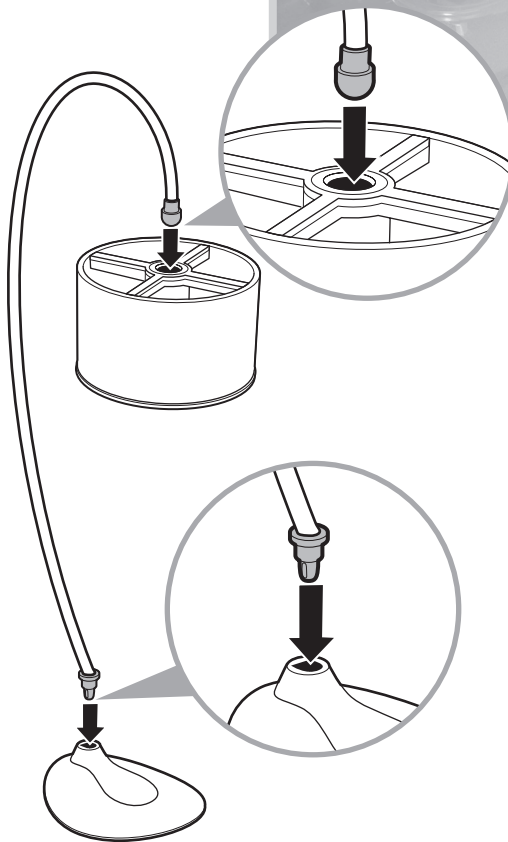

## CONSUMER INFORMATION

Need Assistance? Visit [service.mattel.com](http://service.mattel.com) or call 1-800-524-8697 (US and Canada only), M-F 9AM - 7PM & SAT 11AM - 5PM, Eastern.

[SERVICE.MATTEL.COM](http://SERVICE.MATTEL.COM)

Mattel Canada Inc., Mississauga, Ontario L5R 3W2. You may call us free at/ Composez sans frais le 1-800-524-8697.

Mattel U.K. Ltd., Varwall Business Park, Maidenhead SL6 4UB, Helpline 01628 500303.

Mattel Australia Pty., Ltd., Richmond, Victoria, 3121. Consumer Advisory Service - 1300 135 312.

Mattel East Asia Ltd., Room 1106, South Tower, World Finance Centre, Harbour City, Tsimshatsui, HK, China.

Diimport & Diedarkan Oleh: Mattel SEA Ptd Ltd.(993532-P) Lot 13.5, 13th Floor, Menara Lien Hoe, Persiaran Tropicana Golf Country Resort, 47410 PJ. Tel:03-78803817, Fax:03-78803867.  
Mattel, Inc., 333 Continental Blvd., El Segundo, CA 90245 U.S.A. Consumer Relations 1 (800) 524-8697.