

Fisher-Price
GeoTrax
Transportation System

Please keep this instruction sheet for future reference,
as it contains important information.
Adult assembly is required. No tools required for assembly.
Wipe the toy with a clean, damp cloth. Do not immerse. Do not drop this toy on a hard surface.
This toy has no consumer serviceable parts. Do not take this toy apart.

Visit www.fisher-price.com
to see the entire world
of GeoTrax® accessories!



GeoTrax
Transportation System

CONSUMER ASSISTANCE
Call toll free: 1-800-432-5437 (US & Canada only)
M-F 9AM to 7PM / SAT 11AM to 5PM (EST)

service.fisher-price.com

Write to us at: Fisher-Price® Consumer Relations,
636 Girard Avenue, East Aurora, New York 14052.
Hearing-impaired consumers using TTY/TDD equipment,
please call 1-800-382-7470.

For countries outside the United States:
Canada: Mattel Canada Inc., 6155 Freemont Blvd.,
Mississauga, Ontario L5R 3W2; www.service.mattel.com.
Great Britain: Mattel UK Ltd, Vanwall Business Park,
Maidenhead SL6 4UB, Helpline: 01628 500303,
www.service.mattel.com/uk
Australia: Mattel Australia Pty. Ltd., 658 Church Street,
Locked Bag #870, Richmond, Victoria 3121 Australia.
Consumer Advisory Service 1300 135 312.
New Zealand: 16-18 William Pickering Drive,
Albany 1331, Auckland.
Asia: Mattel East Asia Ltd, Room 1106, South Tower,
World Finance Centre, Harbour City, Tsimshatsui, HK, China.

Assembled Parts

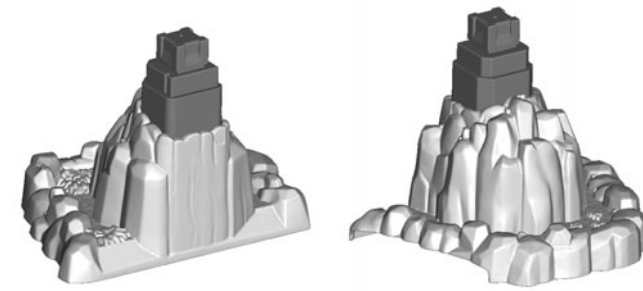

2 Small Bases

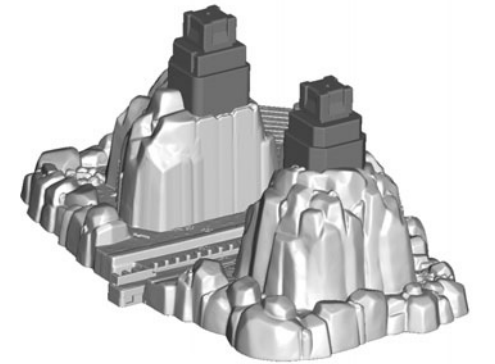

Large Base

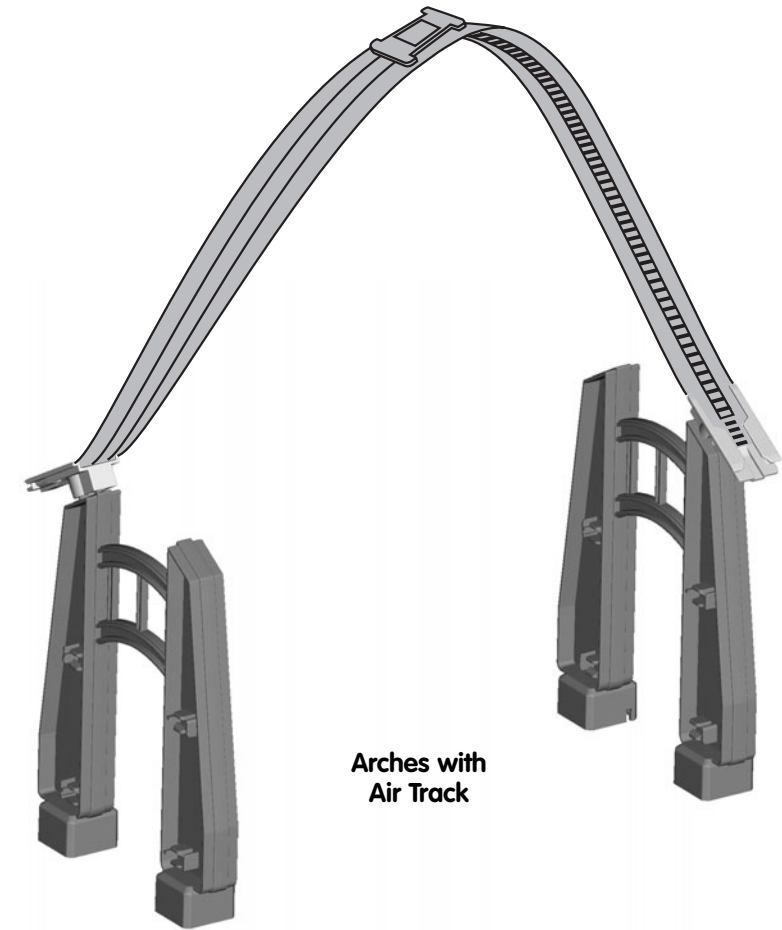

Arches with
Air Track

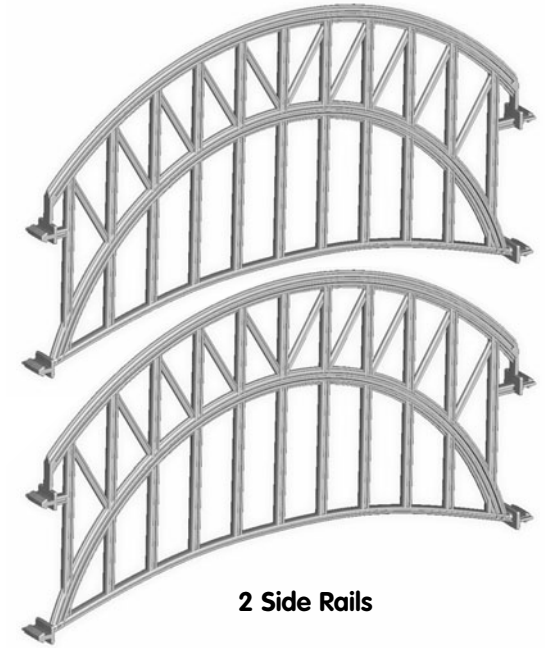

2 Side Rails

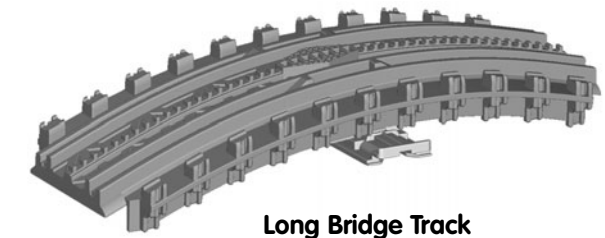

Long Bridge Track

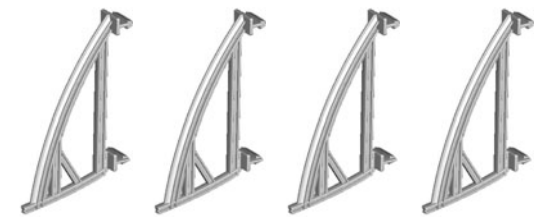

4 End Rails

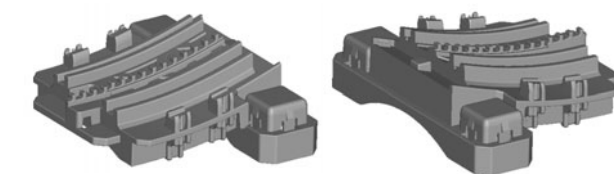

2 Short Bridge
Tracks

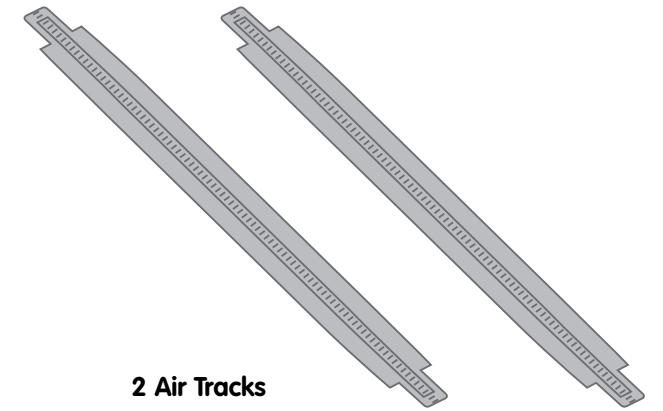

2 Air Tracks

Assembly

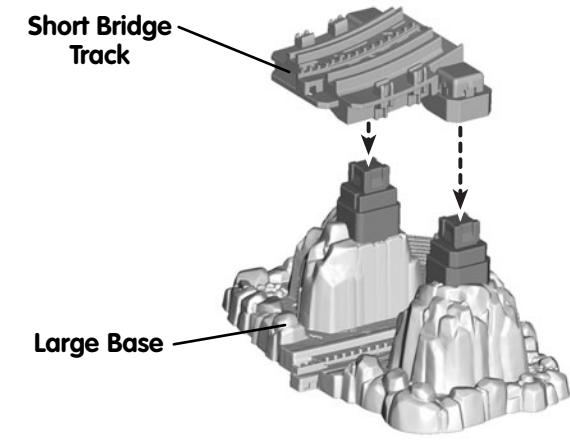

1

- “Snap” a short bridge track onto the large base, as shown.

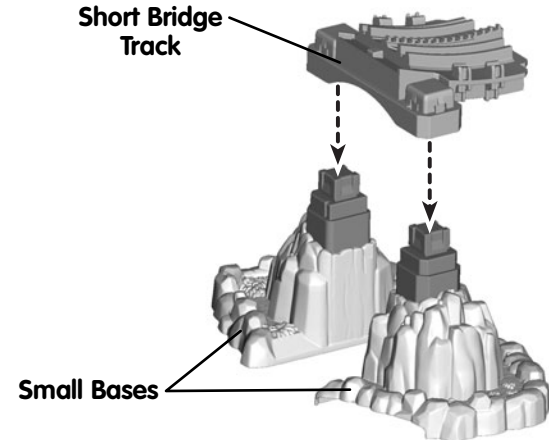

2

- Position the small bases next to each other, as shown. Make sure the flat side of each base faces each other.
- “Snap” the other short bridge track onto the small bases, as shown.

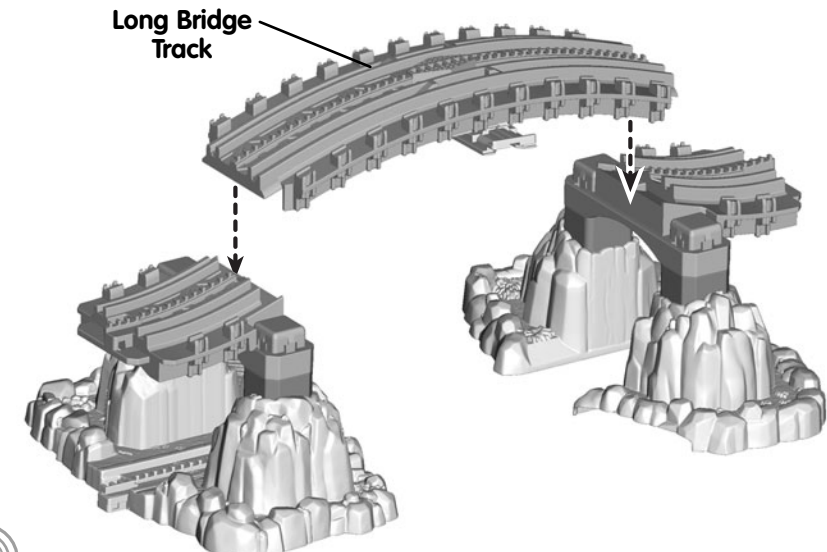

3

- “Snap” the long bridge track onto the both base assemblies.

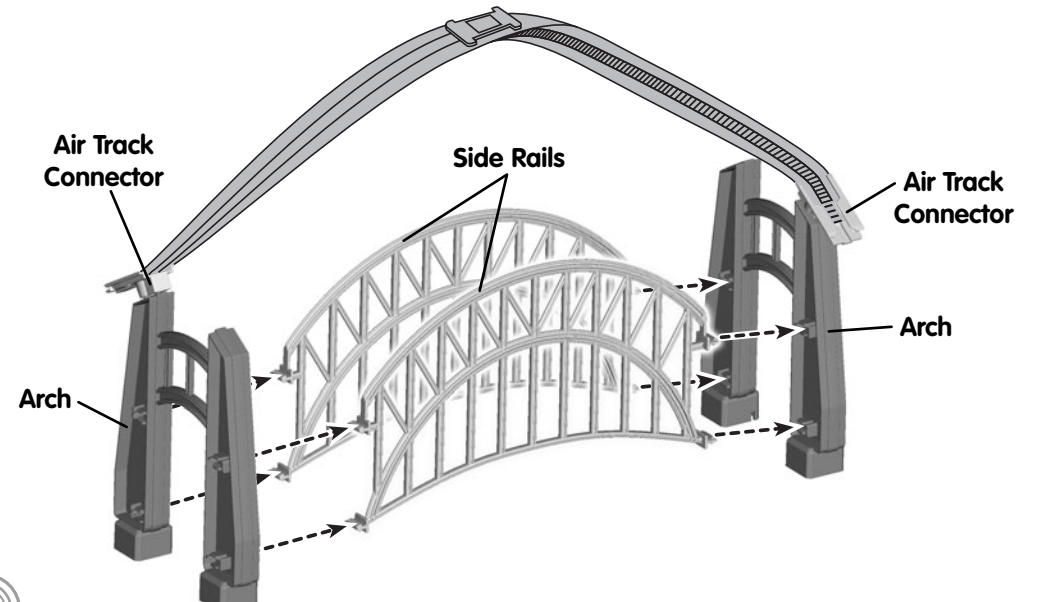

4

- “Snap” the ends of both side rails into the arches, as shown.
- Note:** The air track needs to form the configuration shown. Turn the air track connectors to adjust the air track.

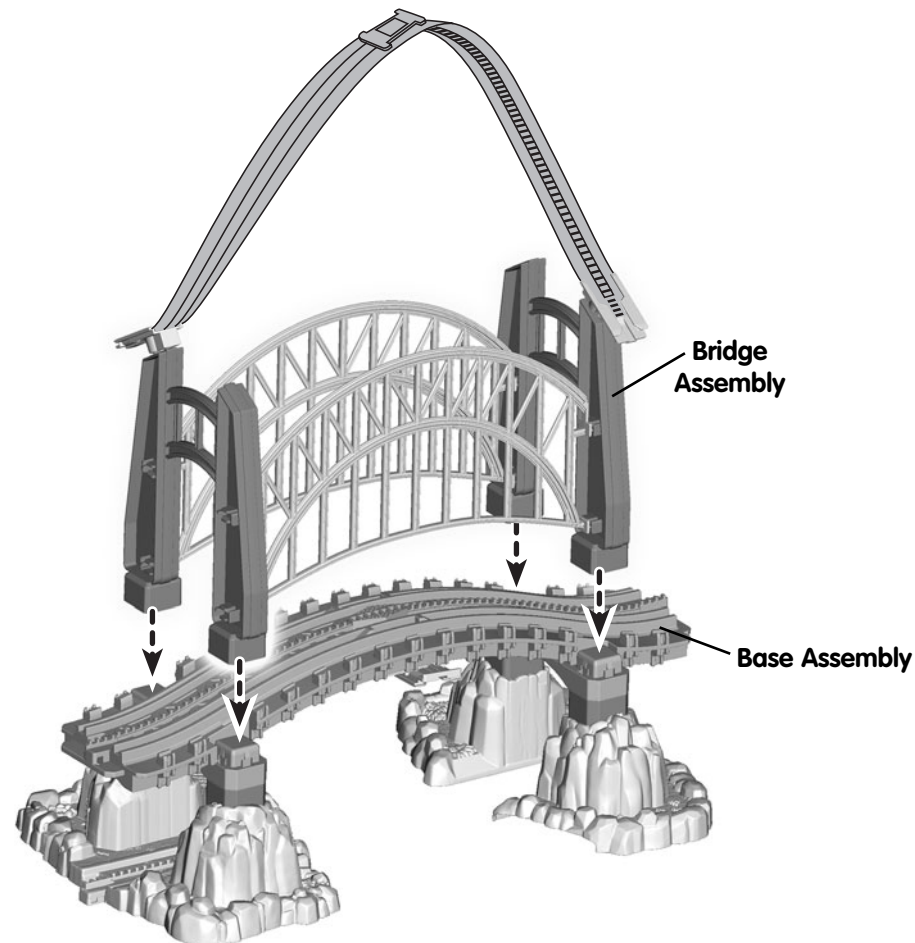

5

- “Snap” the bridge assembly onto the base assembly.

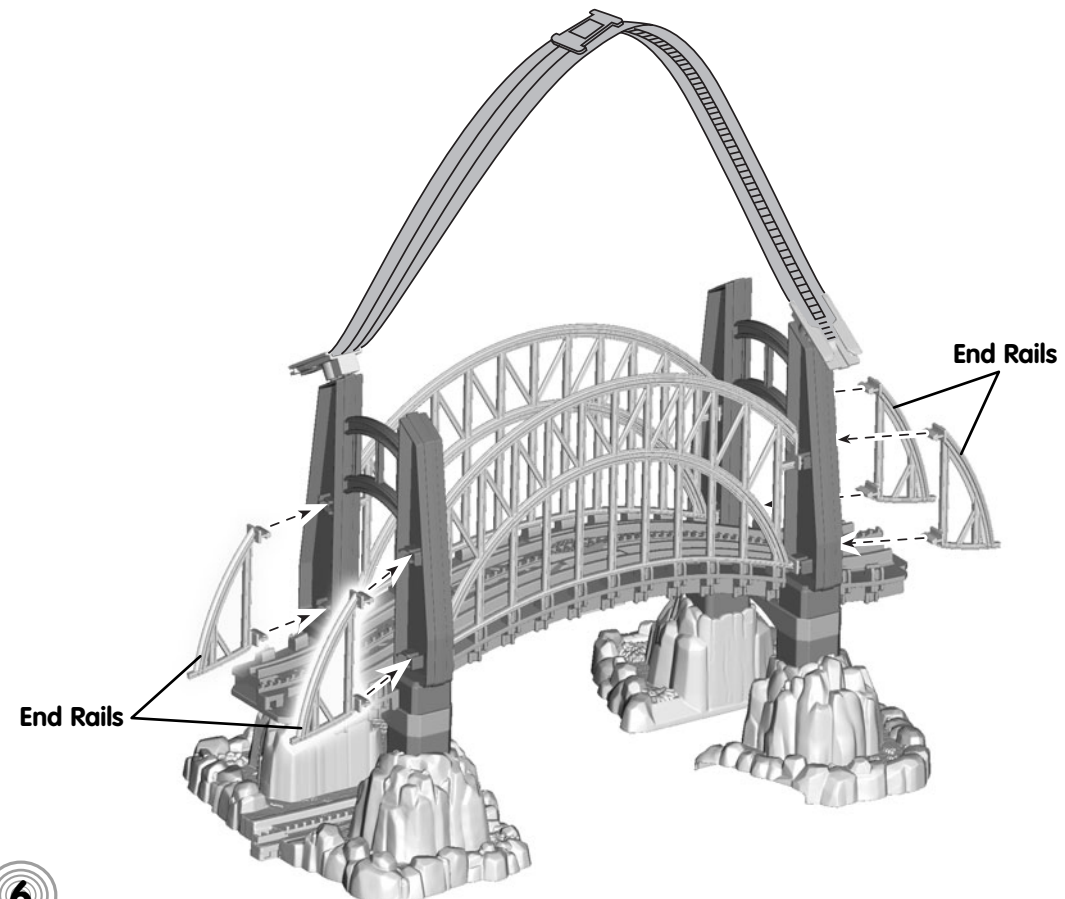

6

- “Snap” two end rails to each arch, as shown.

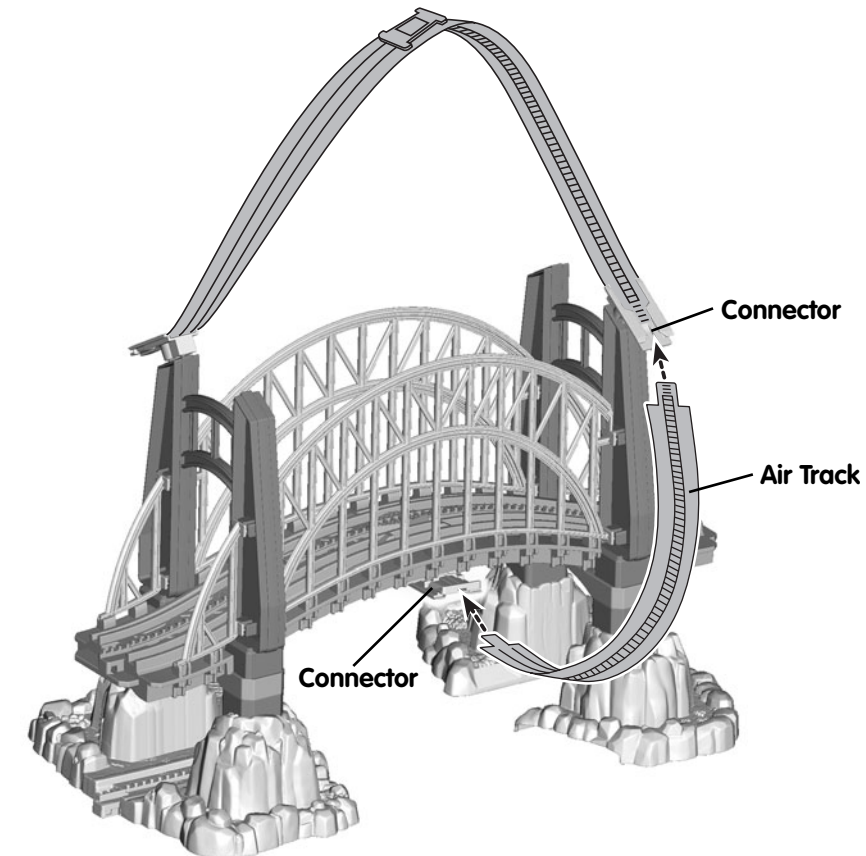

7

- Slide a air track into the bottom of the connector on an arch.
- Attach the free end to the air track connector under the bridge.
- Repeat this procedure with the other air track on the other side of the bridge.